



SURGERY



Hauptkatalog | Catalogue Général
Main Catalog | Catálogo General
Catalogo Generale





Ihr Komplettanbieter für die Chirurgie

Solutions for surgery

Solutions pour la chirurgie

Soluciones para la cirugía

Soluzioni per la chirurgia





Ihr Komplettanbieter für die Endoskopie

Solutions for endoscopy

Solutions pour l'endoscopie

Soluciones para la endoscopia

Soluzioni per la endoscopia





Die perfekten Lösungen für den OP

Perfect solutions for the OR

Solutions parfaits pour le bloc opératoire

Soluciones perfectas para el quirófano

Soluzioni perfetti per la sala operatoria

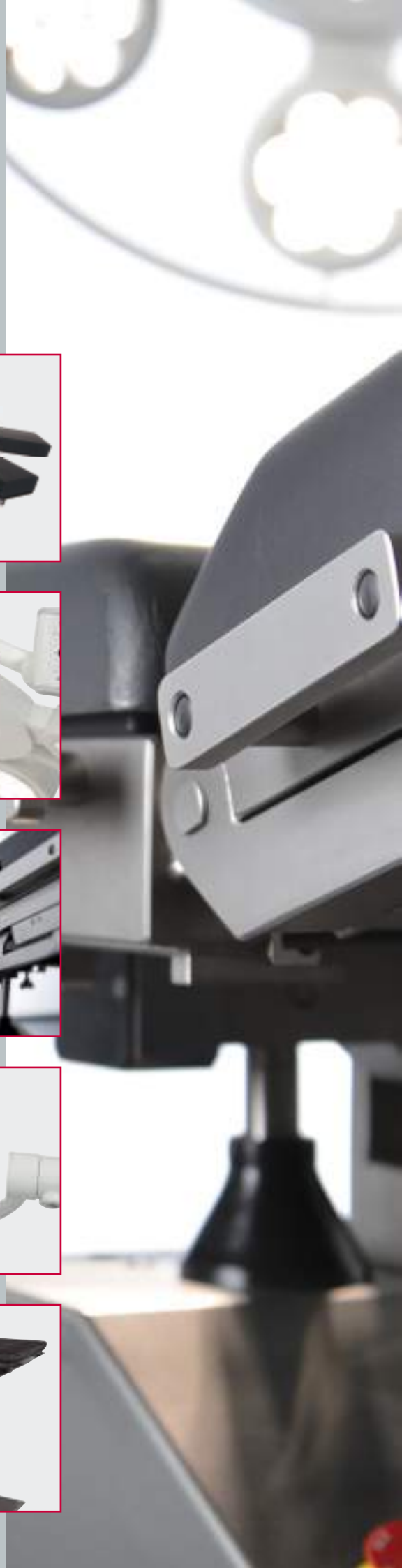



Die Marke für beste Qualität

The brand for superior quality

La marque pour la qualité supérieur

La marca para la calidad superior

Il marchio per una qualità superiore

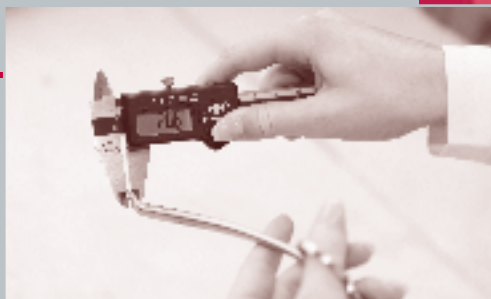
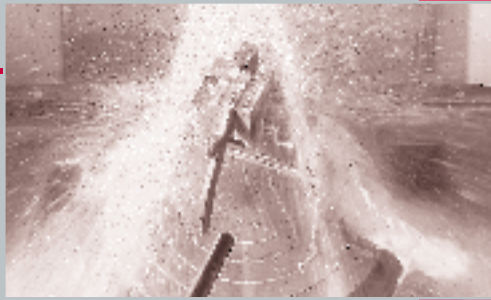
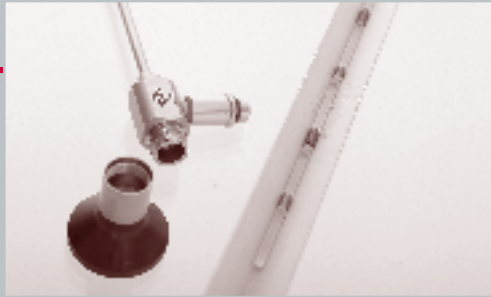



Tekno-Medical Optik-Chirurgie GmbH hat seinen Standort im Weltzentrum der Medizintechnik in Tuttlingen, Deutschland. Das Unternehmen ist seit mehr als 40 Jahren auf dem nationalen und internationalen Markt in über 120 Ländern erfolgreich. Das komplette Produktprogramm umfasst Instrumente und Geräte für die allgemeine Chirurgie, Endoskopie, HF-Chirurgie, OP-Tische und OP-Leuchten. Das Familienunternehmen vereint ein breites Produktspektrum mit persönlicher Beratung und Betreuung. Die Fachkompetenz, Erfahrung und Begeisterung der Mitarbeiter ist die Basis für umfassenden und zuverlässigen Service. Die hohe Produktqualität sowie die Bedürfnisse der Kunden bestimmen den visionären Blick in die Zukunft.

Tekno-Medical Optik-Chirurgie GmbH has its base in the world center of medical technology in Tuttlingen, Germany. Since more than 40 years, the company is successful in the national and international markets in more than 120 countries worldwide. The entire product range covers all instruments and OR-equipment for standard surgery and endoscopy, HF-surgery, OR tables and OR lights. The family-owned enterprise combines a vast product variety with a personal guidance and support of all customers. The professional competence, experience and enthusiasm of the employees are the basis for comprehensive and reliable service. The high quality of products as well as the necessities of our customers determine the vision for the future.

Tekno-Medical Optik-Chirurgie GmbH est située à Tuttlingen, Allemagne, le centre mondial de la technologie médicale. L'entreprise travaille avec grand succès, depuis 40 ans, sur les marchés nationaux et internationaux dans 120 pays du monde. La gamme complète de produits inclut tous les instruments et dispositifs pour la chirurgie générale, l'endoscopie, la chirurgie de haute fréquence, tables, lampes et scalytiques de salles d'opération. Les produits de Tekno-Medical sont distribués dans 120 pays du monde. L'entreprise familiale réunit une grande diversité de produits avec un personnel toujours aux soins de la clientèle. La compétence professionnelle, l'expérience et l'enthousiasme de nos employés forment la base pour un service intégral fiable. La haute qualité des produits et le besoins de nos clients déterminent les visions pour le future.

Tekno-Medical Optik-Chirurgie GmbH se encuentra en el centro mundial de tecnología médica en Tuttlingen, Alemania. La compañía ha tenido éxito en más de 120 países en el mercado nacional e internacional durante más de 40 años. La gama completa de productos incluye instrumentos y equipos para cirugía general, endoscopia, cirugía de alta frecuencia así como mesas y lámparas de operaciones. El negocio familiar combina una amplia gama de productos con apoyo y asesoramiento personal. La competencia profesional, experiencia y entusiasmo de los empleados es la base para un servicio integral y fiable. La alta calidad del producto así como los requerimientos de los clientes determinan el aspecto con visión de futuro.

Tekno-Medical Optik-Chirurgie GmbH ha la sua base nel centro mondiale della tecnologia chirurgica, a Tuttlingen, in Germania. L'azienda a un grande successo sui mercati nazionali ed internazionali in più di 120 paesi da 40 anni. L'intera gamma di prodotti copre tutti gli strumenti e le attrezzature per la chirurgia standard ed endoscopia, l'elettrochirurgia, i tavoli e le luci da sala operatoria. L'impresa a conduzione familiare combina una vasta gamma di prodotti con una guida sempre personale e il supporto per tutti i clienti. La competenza professionale, l'esperienza e l'entusiasmo dei dipendenti sono la base per il servizio completo e affidabile. L'alta qualità del prodotto, come anche il bisogno dei nostri clienti determinano la visione per il futuro.



Über uns – About us – Nous connaître – Sobre nosotros – Su di noi



Medical

Medical

Firmengründer Bruno Mattes und seine Söhne Florian und Harald Mattes bilden die Geschäftsführung des Familienunternehmens. Als starkes Team vereinen die drei Persönlichkeiten Erfahrung, Engagement, Leidenschaft, Know-How, Tradition und Zukunftsvision. Mit Weitblick wird an die bislang erreichten Erfolge angeknüpft, um für die Zukunft weiterhin entscheidende Akzente zu setzen und die über 40jährige Unternehmensgeschichte erfolgreich weiterzuführen. Als Unternehmensleitgedanke setzt Tekno-Medical Optik-Chirurgie GmbH drei zentrale Maximen in den Fokus: Erfahrung und Kompetenz, Service und Kundenorientierung sowie Vertrauen und Zuverlässigkeit.

Founder Bruno Mattes and his sons Harald and Florian Mattes form the management board of the family-owned enterprise. As a competent team, these three personalities combine experience, commitment, passion, know-how, tradition and orientation towards the future. The vision is tied up to the so far achieved success to carry on setting vital priorities and continue the 40 years of company history successfully. As a family-owned company Tekno-Medical Optik-Chirurgie GmbH has set three central maxims in the focus: experience and competence, service and customer orientation as well as confidence and reliability.

Le fondateur, M. Bruno Mattes et ses fils Harald et Florian Mattes forment la gérance de l'entreprise familiale. Équipe forte, les trois ou la direction personnalités unissent expérience, engagement, passion, know-how, cette équipe forte de trois personnalités unissent savoir-faire, tradition et orientation vers le futur. La vision est liée aux succès atteints jusqu'au présent, pour donner des nouvelles orientations directives et continuer l'histoire de l'entreprise de 40 ans. Comme entreprise familiale, Tekno-Medical Optik-Chirurgie GmbH a mis trois maximes dans le focus: expérience et compétence, service et orientation client ainsi que confiance et fiabilité.

El fundador de la empresa Bruno Mattes y sus hijos Florian y Harald Mattes forman la gestión de la empresa familiar. Como un fuerte equipo, combinan las tres personalidades con experiencia, compromiso, pasión, know-how, tradición y visión de futuro. La visión a largo plazo está vinculada a los logros alcanzados hasta ahora, para seguir marcando acentos decisivos en el futuro y continuar exitosamente los más de 40 años de historia de la compañía. Como filosofía corporativa se enfoca Tekno-Medical Optik-Chirurgie GmbH en tres máximas fundamentos: Experiencia y Competencia, Servicio y Orientación al cliente, así como Confianza y Fiabilidad.

Il fondatore Bruno Mattes e i suoi figli Harald e Florian Mattes sono gli amministratori dell'impresa a conduzione familiare. Come un team competente, queste tre personalità combinano l'esperienza, l'impegno, la passione, il know-how, la tradizione e l'orientamento verso il futuro. La visione del futuro è legata al successo ottenuto da così lungo tempo portando avanti la definizione delle priorità vitali e continuando i 40 anni di storia dell'azienda con successo. Come azienda a conduzione familiare la Tekno-Medical Optik-Chirurgie GmbH ha tre importanti punti focali: esperienza e competenza, il servizio e orientamento al cliente, nonché la fiducia e affidabilità.



Unser Anspruch – Our ambition – Notre exigence – Nuestra exigencia – Le nostre esigenze

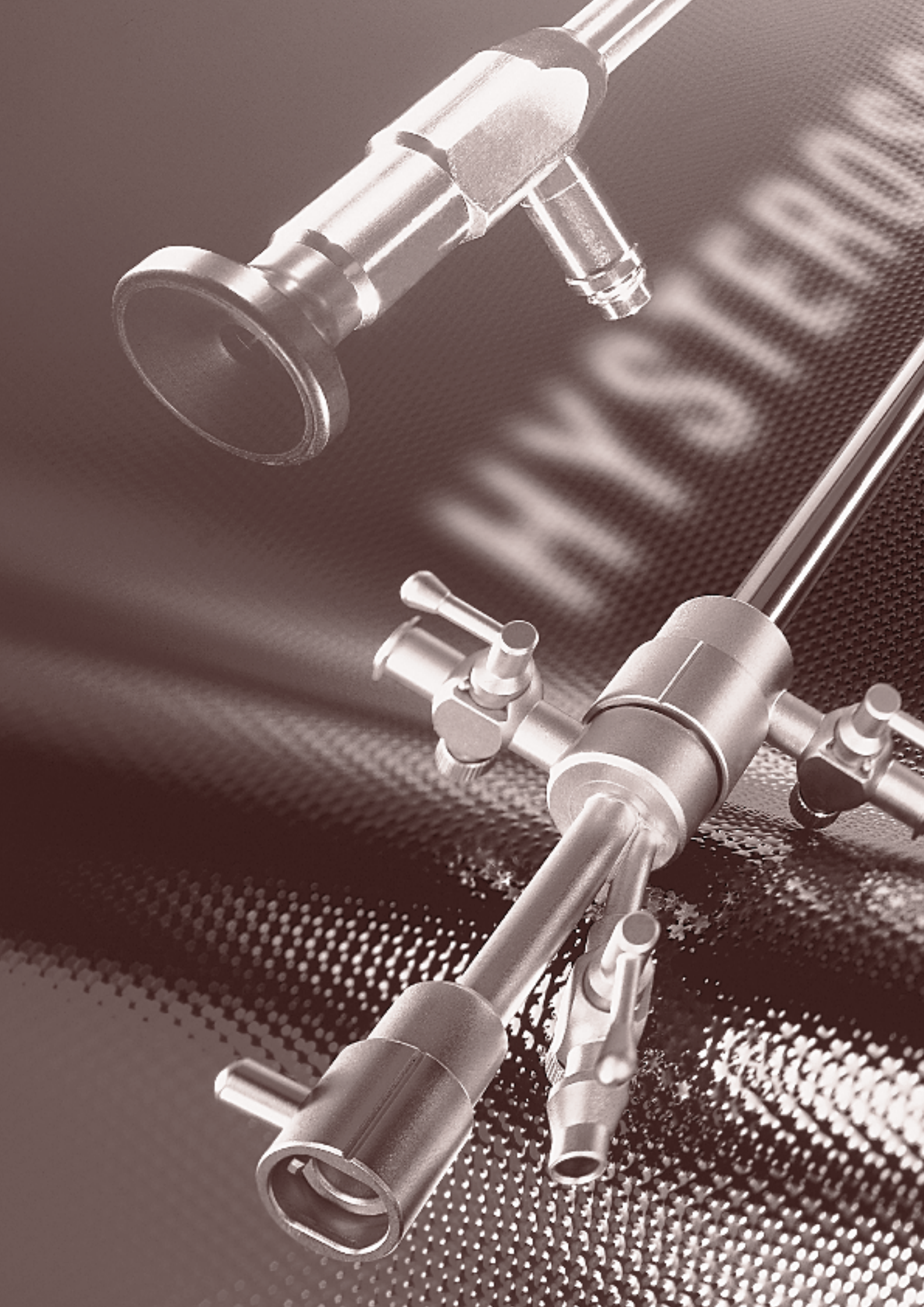

Tekno-Medical Optik-Chirurgie GmbH wurde 1976 durch Bruno Mattes gegründet und wird bis heute als Familienunternehmen geführt. Durch qualifizierte Mitarbeiter und die hohe Qualität der Produkte und Dienstleistungen konnte Tekno-Medical ein stetiges Wachstum vollziehen. Im Jahr 1990 erfolgte die Gründung einer eigenen Produktionsstätte, die zu einem modernen und leistungsfähigen Fertigungsbetrieb herangewachsen ist. Aufgrund steigender Auftragsvolumina wurde 1999 der Neubau eines modernen Logistikzentrums realisiert. Der Eintritt der beiden Söhne des Firmengründers, Florian und Harald Mattes in die Geschäftsleitung im Jahr 2008, stellte einen wichtigen Schritt in die gesicherte Zukunft des Familienunternehmens dar. Erfolg und stetiges Wachstum erforderten 2013 einen zusätzlichen Neubau von über 1.000m² für die Bereiche Verwaltung und Logistik.

Tekno-Medical Optik-Chirurgie GmbH has been founded in 1976 by Bruno Mattes and is still run as a family-owned company. Due to the qualified employees and high quality standard of the products and services, Tekno-Medical could achieve a continuous growth. In 1990 the own production plant was founded, which is nowadays one of the most modern and efficient manufacturing facilities. Due to the increasing volume of orders in 1999 the construction of a state of the art logistic center has been realized. The admission of the founder's sons, Florian and Harald Mattes to the management board in 2008, is an important step into the secured future of the family-owned enterprise. Success and ongoing growth required in 2013 an additional area for administration and logistics with more than 1.000 sqm.

Tekno-Medical Optik-Chirurgie GmbH était fondée en 1976 par M. Bruno Mattes et est toujours une entreprise familiale. Des employés qualifiés et le haut standard de qualité des produits et prestations, constituent la base pour la croissance durable de l'entreprise. En 1990 débutait une entreprise productive, qui se présente aujourd'hui comme une fabrique moderne et efficace. La progression continue requérait en 1999 la construction d'un centre logistique moderne. L'entrée des fils du fondateur, Harald et Florian Mattes dans la gérance en 2008 marquait un pas important et engageait l'avenir de l'entreprise familiale. L'optimisation des processus et l'expansion du portfolio, nécessitaient en 2013 un édifice additionnel pour l'administration et la logistique avec plus de 1.000m².

Tekno-Medical Optik-Chirurgie GmbH fue fundada en 1976 por Bruno Mattes y todavía se gestiona como una empresa familiar. A través de sus empleados altamente cualificados y la alta calidad de sus productos y servicios ha sido capaz Tekno-Medical de lograr un crecimiento constante. En el año 1990 se efectuó la fundación de nuestra propia planta de producción, que se ha convertido en una empresa de fabricación moderna y eficiente. Debido al creciente volumen de pedidos se realiza la nueva construcción de un moderno centro logístico en el año 1999. La entrada de dos de los hijos del fundador de la empresa, Florian y Harald Mattes a la dirección en 2008, representó un paso importante en el futuro asegurado del negocio familiar. El éxito y el crecimiento constante requirieron un nuevo edificio adicional de más de 1.000 m² para administración y logística en 2013.

La Tekno-Medical Optik-Chirurgie GmbH è stata fondata nel 1976 da Bruno Mattes ed è tuttora gestita come azienda a conduzione familiare. Grazie ai dipendenti qualificati e all'elevato standard qualitativo dei prodotti e dei servizi la Tekno-Medical ha potuto avere una crescita continua. Nel 1990 è stato fondato il proprio impianto di produzione, che è oggi una delle fabbriche più moderne ed efficienti. Grazie al crescente volume di ordini nel 1999 è stata realizzata la costruzione di un centro logistico che rappresenta lo stato dell'arte. L'ingresso dei figli del fondatore, Harald e Florian Mattes nel consiglio di amministrazione, nel 2008, è stato un passo importante verso il futuro dell'impresa a conduzione familiare. L'ottimizzazione dei processi e l'estensione del portafoglio prodotti ha reso necessario la costruzione nel 2013 di una superficie aggiuntiva per l'amministrazione e per la logistica con più di 1.000 mq.





Die Qualität der Produkte war Tekno-Medical schon immer eine Herzensangelegenheit. Daher war es selbstverständlich bei der Einführung der ISO-Zertifizierung zu den ersten Firmen zu gehören, welche erfolgreich zertifiziert wurden und ihre Instrumente mit der CE-Kennzeichnung versehen durften. Tekno-Medical ist zudem von der FDA geprüft und dadurch in der Lage, die Produkte auch in die USA zu exportieren. Um den hohen Qualitätsanspruch an Medizinprodukte gerecht zu werden, wurde bereits 2003 das auf Produktsicherheit zielende Qualitätsmanagement nach DIN EN ISO 13485 eingeführt. Unser Anspruch geht über die eindimensionale Produktqualität hinaus. Tekno-Medical sieht sich als Qualitätsanbieter und optimiert stetig Prozesse mit dem Ziel, die Kunden umfassend zu bedienen.

The quality of our products has always been a labour of love for us. Therefore, it was obvious for TEKNO-MEDICAL to be among the first companies who achieved the ISO-certification and who were allowed to mark their products with the CE-mark. In addition to that, TEKNO-MEDICAL is approved by the FDA and so allowed to export its products to the United States of America. In order to meet the high quality requirements for medical products, TEKNO-MEDICAL introduced already in 2003 the Quality Management according to DIN EN ISO 13485, which aims the product safety. Our claim is beyond the one-dimensional product quality. Tekno-Medical regards itself as a quality provider and optimizes the processes continuously with the aim to serve the customer on a comprehensive base.

La qualité de nos produits reste toujours notre principal but. C'est pourquoi il nous semble évident d'être parmi les premières entreprises à avoir passé avec succès les certifications ISO, permettant de marquer nos instruments avec la mention «CE». TEKNO-MEDICAL est de plus certifiée par la FDA et par conséquent est en mesure de pouvoir exporter ses produits aux Etats Unis. Afin de répondre aux exigences de haute qualité pour les dispositifs médicaux, qui visait la sécurité des produits, a été introduite à partir de 2003 la gestion de la qualité selon DIN EN ISO 13485, qui visait la sécurité des produits. Notre exigence dépasse la qualité de produit unidimensionnel. Tekno-Medical se considère comme un fournisseur de qualité et optimise constamment les processus avec le but de servir les clients de manière exhaustive.

La calidad de los productos ha sido siempre un objetivo primordial para Tekno-Medical. Por lo tanto, era evidente estar entre las primeras empresas que han aprobado con éxito la introducción de las certificaciones ISO y que han obtenido el marcado CE de sus productos. Tekno-Medical también es aprobado por la FDA y por lo tanto es capaz de exportar los productos a los EE.UU. Con el fin de cumplir con los requisitos de alta calidad para productos médicos, fue introducido desde el 2003 el sistema de gestión de calidad que tiene como objetivo la seguridad del producto de acuerdo a DIN EN ISO 13485. Nuestra exigencia va más allá de la calidad del producto unidimensional. Tekno-Medical se ve a sí misma como un proveedor de calidad y optimiza constantemente los procesos con el objetivo de servir a los clientes de manera integral.

La qualità dei nostri prodotti è sempre stata e sempre sarà il nostro principale interesse. Quindi è stato naturale per la TEKNO-MEDICAL essere tra le prime aziende a ricevere la certificazione ISO e a cui è stato concesso di marchiare i propri prodotti con il marchio CE. Oltre a ciò TEKNO-MEDICAL ha l'approvazione dell'FDA ed è così autorizzata ad esportare i propri prodotti negli Stati Uniti d'America. Per raggiungere i più alti standard richiesti per i prodotti medicali la Tekno-Medical ha introdotto già nel 2003 il Sistema Qualità in accordo alle DIN EN ISO 13458, relative alla sicurezza del prodotto. La nostra tesi è al di là della semplice qualità mono-dimensionale del prodotto. Tekno-Medical si proclama fornitore di qualità e ottimizza continuamente i processi con l'obiettivo di servire il cliente su una base completa.

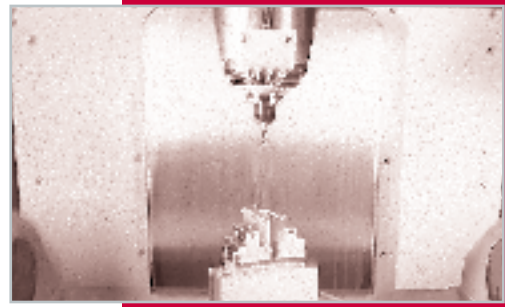

Unsere Qualität – Our quality – Notre qualité – Nuestra calidad – Nostro qualità



1
 Diagnostik, Narkose
Diagnostics, Anaesthesia

Diagnostic, Anesthésie
Diagnóstico, Anestesia
 Diagnostica, Anestesia

1 - 36



2
 Aspiration, Sonden
Aspiration, Probes

Aspiration, Sondes
Aspiración, Sondas
 Aspirazione, Sonde

37 - 58



3
 Skalpel, Messer
Scalpels, Knives

Bistouris, Couteaux
Bisturías, Cuchillos
 Bisturi, Coltelli

59 - 72



4
 Scheren
Scissors

Ciseaux
Tijeras
 Forbici

73 - 148



5
 Pinzetten
Forceps

Pinces
Pinzas
 Pinze

149 - 180



6
 Arterienklemmen
Haemostatic forceps

Pinces hémostatiques
Pinzas hemostáticas
 Pinze emostatiche

181 - 232



7
 Tupferzangen
Cotton swap forceps

Pinces à tampons et à pansements
Pinzas para tapónes y vendajes
 Pinze per tamponi e per medicazione

233 - 242



8
 Wundhaken
Retractors

Ecarteurs
Separadores
 Divaricatori

243 - 330

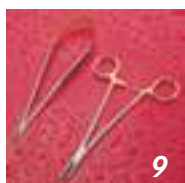

9
 Naht
Suture

Suture
Sutura
 Sutura

331 - 376



10
 Gefäßchirurgie
Vascular surgery

Chirurgie vasculaire
Cirugía vascular
 Chirurgia vascolare

377 - 436



11

Verband
Dressings

Pansements
Vendajes
Bendaggi

437 - 446



12

Knochenchirurgie
Bone surgery

Chirurgie osseuse
Cirurgía ósea
Chirurgia ossea

447 - 564



13

Mikro- und Neurochirurgie
Micro- and neuro surgery

Chirurgie micro et neuro
Cirurgía micro y neuro
Micro- e Neuro-Chirurgia

565 - 652



14

Thorax, Lunge
Thorax, Lung

Thorax, Poumon
Tórax, Pulmón
Torace, Polmone

653 - 674

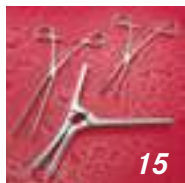

15

Magen, Darm
Stomach, Intestine

Estomac, Intestins
Estómago, Intestino
Stomaco, Intestino

675 - 708



16

Urologie
Urology

Urologie
Urología
Urologia

709 - 728

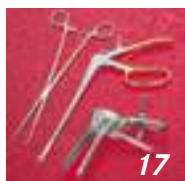

17

Gynäkologie
Gynecology

Gynécologie
Ginecología
Ginecologia

729 - 780



18

HNO
ENT

ORL
ORL
ORL

781 - 892



19

Autopsie
Autopsy

Autopsie
Autopsia
Autopsia

893 - 904

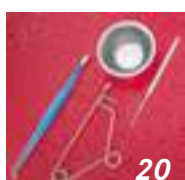

20

Verschiedenes
Miscellaneous

Articles divers
Diversos artículos
Articoli vari

905 - 930



Diagnostik, Narkose
Diagnosics, Anaesthesia

Diagnostic, Anesthésie
Diagnóstico, Anestesia
Diagnostica, Anestesia

Perkussionshämmer
Percussion Hammers

Marteaux-percuteurs
Martillos de percusión
Martelli percussori



Perkussionshämmer
Percussion Hammers

Marteaux-percuteurs
Martillos de percusión
Martelli percussori

WARTENBERG

190 mm – 7"

tk 4200-19

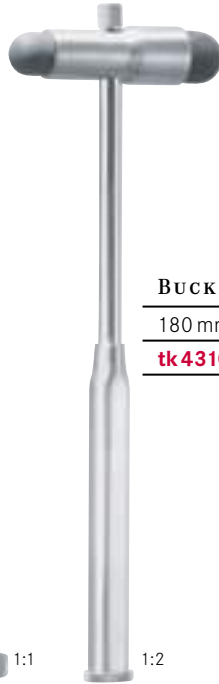

BUCK

180 mm – 7"

tk 4310-18



TROEMNER

240 mm – 9½"

tk 4313-24



TAYLOR

180 mm – 7"

tk 4320-18

200 mm – 8"

tk 4320-20



BERLINER

200 mm – 8"

tk 4330-20



DÉJERINE

210 mm – 8"

tk 4340-21

Diagnostik-Bestecke
Diagnostic sets

Trousses à diagnose
Juegos para diagnóstico
Astucci diagnostici



tk 4425-00

Ophthalmoskop-Besteck
Ophthalmoscope set
Trousse à ophtalmoscopie
Ophthalmoscopio
Oftalmoscopio



tk 4430-00

Universal-Besteck
Universal set
Trousse universelle
Estuche universal
Astuccio universale

Diagnostik-Bestecke
Diagnostic sets

Trousses à diagnose
Juegos para diagnóstico
Astucci diagnostici



tk 4432-00

Kombinations-Besteck
Combination set

Trousse combinée
Estuche combinado
Astuccio combinato



tk 4434-00

Otoskop-Besteck
Otoscope set

Trousse à otoscopie
Otoscopio
Otoscopio

Stethoskope | Stéthoscopes
Stethoscopes | Estetoscopios
Stetoscopi



1:2

PINARD
180 mm - 7"
tk4099-18

Holz
Wood
Bois
Madera
Legno



1:2

PINARD
150 mm - 6"
tk4100-15

Aluminium
Aluminium
Aluminium
Aluminio
Alluminio



1:4

DUPLEX
47 mm | **tk4500-00**

für Erwachsene
for adults
pour adultes
para adultos
per adulti

BABY-DUPLEX
37 mm | **tk4500-50**

für Kinder
for children
pour enfants
para niños
per bambini



1:1

ANESTOPHON
47 mm | **tk4505-00**

für Schwestern, einfach
for nurses, simple
pour infirmières, simple
para enfermeras, simple
per infermiere, semplice



1:4

Stirnspiegel
Head mirrors

Miroirs frontaux
Espejos frontales
Specchi frontali



ZIEGLER

90 mm Ø | tk 4550-00

Stirnspiegel mit schwarzem Plastikband
Head mirror with black plastic head band

Miroir frontal avec ruban en plastique noir
Espejo frontal con banda de plastica negra
Specchio frontale con fascia di plastica nera

ZIEGLER

90 mm Ø | tk 4520-09

Reflexspiegel allein, mit Gummifassung
Head mirror only, with rubber coating

Miroir frontal seul, avec monture en caoutchouc
Espejo frontal solo, con guarnición de goma
Solo specchio frontale, con guarnizione di gomma

90 mm Ø | tk 4552-00

Stirnspiegel mit weichem, weissem Plastikband
Head mirror with soft, white plastic head band

Miroir frontal avec ruban en plastique blanc, doux
Espejo frontal con banda de plastica blanca, blanda
Specchio frontale con fascia di plastica bianca, morbida

tk 4510-00

Plastikband, schwarz
Black plastic head band
Ruban en plastique noir
Banda de plastica, negra
Fascia di plastica, nera

tk 4511-00

Plastikband, weiss
White plastic head band
Ruban en plastique blanc
Banda de plastica, blanca
Fascia di plastica, bianca

Kaltlicht-Stirnlampe
Cold-light head lamp

Eclaireur frontal de lumière froide
Lámpara frontal de luz fría
Lampada frontale a luce fredda

BINNER

tk 4559-00

Kaltlicht-Stirnlampe mit verstellbarer Fokussierlinse,
Arbeitsabstand 300 mm, Leuchtfeldgröße 70 – 120 mm Ø

*Head light, cold-light, adjustable focus,
working distance 300 mm, field of illumination 70 – 120 mm Ø*

Eclaireur frontal, lumière froide, focus ajustable,
distance de travail 300 mm, champ d'illumination 70 – 120 mm Ø

*Lámpara frontal, luz fría, focus ajustable,
distancia de trabajo 300 mm, campo de iluminación 70 – 120 mm Ø*

Lampada frontale, luce fredda, con lente a focale variabile,
distanza di lavoro 300 mm, campo d'illuminazione 70 – 120 mm Ø



Stirnlampen
Head lamps

Eclaireurs frontaux
Lámparas frontales
Lampade frontali



MICRO LED

tk4559-55

Einfaches LED Ausführung mit Batteriebehälter am Reif

Basic LED execution incl. battery box on the headband

Exécution LED de base avec conteneur de piles au ruban

Ejecución LED de base con contenedor de pilas a la banda de plastica

Modello base con led con portapile sulla fascia frontale



XENON

tk4561-50

Xenon Hochleistungslampe 6000Cd mit integrierter Batteriebehälter

Xenon high performance lamp 6000Cd with integrated battery box

Lampe de haute performance xenon 60000Cd avec conteneur des piles incorporé

Boritsilla economica de alta rendimiento Xenon 6000Cd con contenedor de pilas incorporado

Lampada xenon ad alta efficienza 6000Cd con porta batterie integrato

Stirnlampen
Head lamps

Eclaireurs frontaux
Lámparas frontales
Lampade frontali



CLAR

55 mm Ø

tk 4559-30

LED Ausführung inkl. Batteriebehälter

LED execution incl. battery box

Exécution LED avec conteneur des piles

Ejecución LED con contenedor de pilas

Modello a led con porta batterie



POWER LED

tk 4559-50

tk 4559-51

Inkl. Batteriebehälter

Incl. battery box

Avec conteneur des piles

Con contenedor de pilas

Con porta batterie

Inkl. Akkubox

Incl. box for rechargeable batteries

Avec conteneur pour accumulateur

Con contenedor de acumulador

Con porta accumulatori

Leistungsstarke, fokussierbare Stirnleuchte mit weißer LED
Focusable high performance headlight with white LED lamp

Eclaireur frontal, de haute performance, ajustable, lampe LED blanche

Lámpara frontal de alta rendimiento, ajustable, con LED blanco

Lampada frontale ad alto rendimento, regolabile, con led bianco



tk 4559-53

Wie tk 4559-50 jedoch mit Batteriebehälter am Reif

Same as tk 4559-50 but with battery box on the headband

Comme tk 4559-50, mais avec conteneur de piles au ruban

Como tk 4559-50, pero con contenedor de pilas a la banda de plastica

Come tk 4559-50 ma con porta batterie sulla banda frontale

Stirnlampen
Head lamps

Eclaireurs frontaux
Lámparas frontales
Lampade frontali



CLAR

100 mm Ø, 6 V	tk4555-06
---------------	------------------

Stirnlampe komplett
Head light complete

Eclaireur frontal complet
Lámpara frontal, completa
Lampada frontale, completa

100 mm Ø, 6 V	tk4556-06
---------------	------------------

Stirnlampe mit Kabel, Fassung und Spiegel, ohne Stirnreifen
Head light with cable, frame and mirror, without head band

Eclaireur frontal avec cable, douille et miroir, sans ruban
Lámpara frontal, con cable, armadura y espejo, sin banda
Lampada frontale con cavo, supporto e specchio, senza fascia



MINI-CLAR

50 mm Ø, 6 V	tk4560-06
--------------	------------------

komplett
complete
complet
completa
completa

CLAR

50 mm Ø	tk4560-07
---------	------------------

100 mm Ø	tk4555-07
----------	------------------

Spiegel aus Glas, ohne Fassung
Head mirror glass, without frame
Miroir frontal en vitre, sans douille
Espejo frontal de cristal, sin armadura
Vetro specchio, senza supporto

CLAR

tk4557-01

Spezial-Gelenkverbindung
Special socket joint
Assemblage articulé spécial
Conexión
Giunto di connessione speciale

CLAR

tk4557-07

Stirnreifen allein
Head band only
Ruban seul
Banda sola
Solo fascia frontale

6 V

tk4557-06

Glühbirne
Bulb
Ampoule
Bombilla
Lampadina



Input 220 V / 50 Hz ~

Output 0-10 V / 3 W =

tk4585-01

Transformator – stufenlos einstellbar
Transformer – stepless adjustable
Transformateur – à réglage continue
Transformador – regulación continua
Trasformatore – regolabile in continuità

Stirnlampen
Head lamps

 Eclaireurs frontaux
 Lámparas frontales
 Lampade frontali

black headband	tk 4560-10
grey headband	tk 4560-11

OP-Stirnleuchte, für TEKNO-Lichtquellen inkl. Adapter (STORZ) und KL-Kabel 2,5m superleicht
 OP-Headlight for TEKNO-Lightsources incl. adapter (STORZ) and super low-weight fiberoptic cable 2,5m
 Lampe frontale, pour sources de lumière TEKNO avec adaptateur (STORZ) et câble de lumière super légère 2,5m
 Linterna frontal, para funetes de luz TEKNO con adaptador (STORZ) y cable de luz super ligera 2,5m
 Lampada frontale, per fonti luci TEKNO incluso adattatore (STORZ) e cavo luce fredda super leggera 2,5m



black headband	tk 4560-20
grey headband	tk 4560-21

OP-Stirnleuchte, für TEKNO-Lichtquellen inkl. Adapter (STORZ) und KL-Kabel 2,5m
 OP-Headlight for TEKNO-Lightsources incl. adapter (STORZ) and fiberoptic cable 2,5m
 Lampe frontale, pour sources de lumière TEKNO avec adaptateur (STORZ) et câble de lumière 2,5m
 Linterna frontal, para funetes de luz TEKNO con adaptador (STORZ) y cable de luz 2,5m
 Lampada frontale, per fonti luci TEKNO incluso adattatore (STORZ) e cavo luce fredda 2,5m

Stirnlampen
Head lamps

Eclaireurs frontaux
Lámparas frontales
Lampade frontali



tk 4560-30

LED Stirnleuchte POWER FOCUS, kabellos, schwarz, inkl. Akku und Ladegerät
LED Headlight POWER FOCUS, wireless, black incl. accumulator and charger
Lampe frontale LED, POWER FOCUS, sans fil, noir, avec accumulateur et chargeur
Linterna frontal LED, POWER FOCUS, sin alambre, nero, con acumulador y cargador
Lampada frontale LED, POWER FOCUS, senza cavo, nero con accumulatore e caricabatterie



white headband	tk 4560-40
black headband	tk 4560-41

HOCHLEISTUNGS OP Stirnleuchte, LED, kabellos, inkl. zwei Akkus und einem Ladegerät
HIGH POWERED OP-Headlight, LED, wireless, incl. two accumulator and one charger
Lampe frontale de HAUTE PERFORMANCE, LED, sans fil, avec deux accumulateurs et un chargeur
Linterna frontal de ALTA RENDIMIENTO, LED, sin alambre, con dos acumuladores y un cargador
Lampada frontale di ALTO RENDIMENTI, LED, senza cavo, con due accumulatori ed un caricabatterie

Binokularlupe
Binocular magnifying lens

Loupe binoculaire
Lupa binocular
 Lente binoculare



tk 4596-00

2.5 fache Vergrößerung, 340 mm Arbeitsabstand, Sichtfeld > 90 mm Ø, komplett.
 Pupillenabstand einstellbar von 48 mm – 77 mm. Neigungswinkel individuell justierbar.
 Gewicht der Optik 42 g.

*2.5 times enlargement, 340 mm working distance, field of vision > 90 mm Ø, complete.
 Pupillary distance adjustable from 48 mm – 77 mm. Individual adjustable angle of inclination.
 Weight of the optic 42 g.*

2.5 fois grossissement, distance de travail 340 mm, champ de vision > 90 mm Ø, complèt.
 Ecart interpupillaire ajustable de 48 mm – 77 mm. Angle d'inclinaison ajustable individuellement.
 Poids de l'optique 42 g.

*2.5 veces aumento, distancia de trabajo 340 mm, campo de visión > 90 mm Ø, completo.
 Distancia interpupilar ajustable de 48 mm – 77 mm. Angulo de inclinación ajustable individual.
 Peso de la optica 42 g.*

Ingrandimento: 2.5 volte, distanza di lavoro 340 mm, campo di visione > 90 mm Ø, completo.
 Distanza interpupillare regolabile da 48 mm – 77 mm. Angolo di inclinazione regolabile individualmente.
 Peso dell'ottica 42 g.

tk 4596-01

Kopfband
Head band

Ruban
 Banda
 Fascia



Andere Arbeitsabstände und Sichtfelder auf Anfrage.

Other working distances and fields of vision upon request.

Autres distances de travail et champs de vision sur demande.

Otras distancias de trabajo y campos de visión según demanda.

Su richiesta disponibili altre distanze di lavoro e campi di visione.

Blutdruckmessgeräte
Sphygmomanometers

Tensiomètres
Esgfigmomanometros
Sfigmomanometri



tk 4734-00

Manometer-Blutdruckmessgerät, geeicht
Sphygmomanometer, calibrated

Tensiomètre, calibré

Esgfigmomanometro, calibado

Sfigmomanometro, calibrato

Messinstrumente
Measuring instruments

Instruments pour mesurer
Instrumentos de medidas
Strumenti di misura



1:1

COLLIN

125 mm – 5"	tk4605-01	tk4605-02	tk4605-03
	für Kinder, kg-Einteilung <i>for children, kg-scale</i> pour enfants, échelle en kg <i>para niños, graduación en kg</i> per bambini, graduazione in kg	für Erwachsene, kg-Einteilung <i>for adults, kg-scale</i> pour adultes, échelle en kg <i>para adultos, graduación en kg</i> per adulti, graduazione in kg	für Erwachsene, lbs-Einteilung <i>for adults, lbs-scale</i> pour adultes, échelle en lbs <i>para adultos, graduación en lbs</i> per adulti, graduazione in lbs



1:3

BERTILLON

320 mm – 12½" **tk4612-01**



1:2

MOELTGEN

240 mm – 9½" **tk4615-00**

Messinstrumente
Measuring instruments

Instruments pour mesurer
Instrumentos de medidas
Strumenti di misura



100 mm – 4 "	tk 4651-10
150 mm – 6 "	tk 4651-15
200 mm – 8 "	tk 4651-20
300 mm – 12 "	tk 4651-30
500 mm – 20 "	tk 4651-50



500 mm – 20 "	tk 4655-50
---------------	-------------------

Röntgen-Messstab
X-ray ruler
Règle rayons X
Regla para rayos X
Misuratore per raggi X



VERNIER		
210 mm – 8 1/4 "	tk 4620-21	tk 4630-01
Aluminium	Aluminium	Stahl
Aluminium	Aluminium	Steel
Aluminium	Aluminio	Acier
Alluminio	Alluminio	Accaio



CASTROVIEJO	
80 mm – 3 1/4 "	tk 4625-08



1500 mm – 60 "	tk 4668-15
----------------	-------------------

Wachs
Wax cloth
Toile cirée
Cerada
Cera

Zungenspatel | Abaisse-langues
 Tongue depressors | Espatulas bucales
 Abbassalingua



1:2

160 mm – 6¼" | **tk 5482-16**

Holz
 Wood
 Bois
 Madera
 Legno



1:2

145 mm – 5¾" | **tk 5483-14**



1:2

KROENIG
 150 mm – 6" | **tk 5485-15**



1:2

MAYO
 170 mm – 6¾" | **tk 5486-17**



1:2

BRUENINGS
 190 mm – 7½" | **tk 5487-19**



1:2

FRENZEL
 165 mm – 6½" | **tk 5489-16**

Zungendrucker
Tongue depressors

Abaisse-langues
Baja lenguas
Abbassalingua



WIEDER

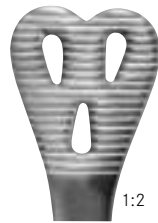

1:2

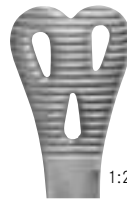

1:2

150 mm – 6"

tk 5479-01

140 mm – 5½"

tk 5479-02



BOSWOTH

1:2

145 mm – 5¾"

tk 5475-14



TOBOLD

1:2

145 mm – 5¾"

tk 5477-14



HARTMANN

1:2

150 mm – 6"

tk 5480-15



ANDREW

1:2

110 mm – 4¾"

tk 5481-11

Zungenzangen
Tongue holding forceps

Pinces tire langue
Pinzas tiralengua
Pinze tiralingua



YOUNG

170 mm - 6¾" **tk 5410-17**

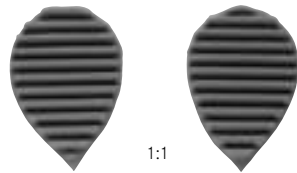

1:1

tk 5410-90

1 Paar Ersatz Gummi-Einsätze
1 Pair rubber-inserts

1 Paire des inserts en caoutchouc
1 Juego de insertos de goma
1 Paio d'inserti di gomma



COLLIN

160 mm - 6¼" **tk 5430-16**

170 mm - 6¾" **tk 5430-17**

190 mm - 7½" **tk 5430-19**

Wangenhalter
Cheek retractors

Ecarteur des joues
Separador de mejillas
Divaricatori per guancia



STERNBERG

120 mm - 4¾" **tk 5471-12**

140 mm - 5½" **tk 5471-14**

160 mm - 6¼" **tk 5471-16**

Katheterzangen
Catheter forceps

Pinces pour cathéters
Pinzas para catéteres
Pinze per catetere

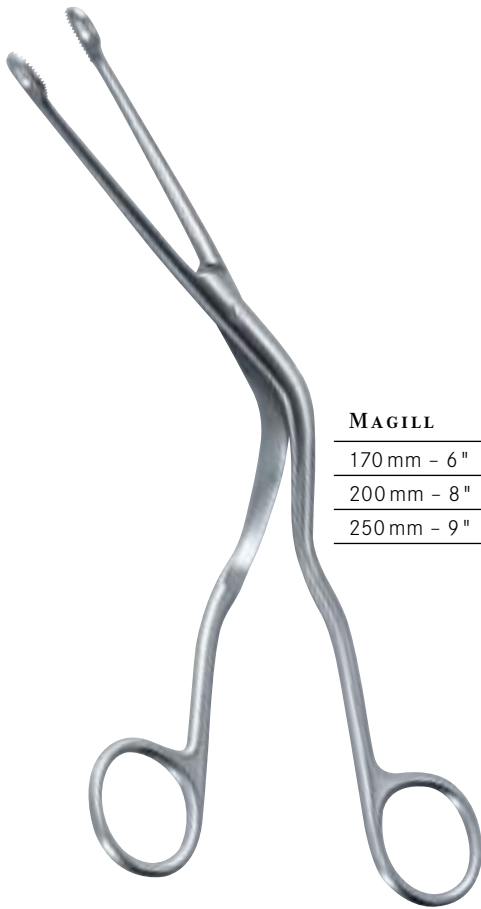

MAGILL

170 mm – 6"	tk 5240-17		
200 mm – 8"		tk 5230-20	
250 mm – 9"			tk 5220-25

Laryngoskope
Laryngoscopes
Laringoscopios
Laringoscopi

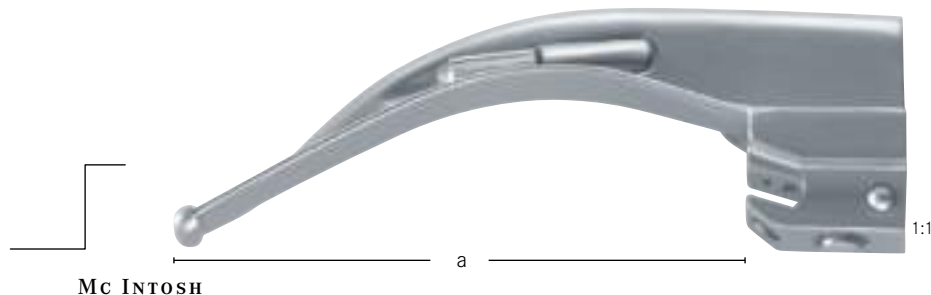

	Fig. 0	Fig. 1	Fig. 2	Fig. 3	Fig. 4	Fig. 5
	a = 55 mm	a = 70 mm	a = 90 mm	a = 110 mm	a = 130 mm	a = 150 mm
	tk 5100-00	tk 5100-01	tk 5100-02	tk 5100-03	tk 5100-04	tk 5100-05
LED	tk 5200-00	tk 5200-01	tk 5200-02	tk 5200-03	tk 5200-04	tk 5200-05

rostfrei
stainless steel
inoxydable
inoxidable
inossidabile



	Fig. 0	Fig. 1	Fig. 2	Fig. 3	Fig. 4	Fig. 5
	tk 5145-02	tk 5145-02	tk 5145-01	tk 5145-01	tk 5145-01	tk 5145-01
LED	tk 5146-01	tk 5146-02	tk 5146-02	tk 5146-02	tk 5146-02	tk 5146-02

Ersatzlampe
Spare lamp
Lampe de rechange
Bombilla de sustitución
Lampadina di ricambio



	Fig. 0	Fig. 1	Fig. 2	Fig. 3	Fig. 4
	a = 55 mm	a = 70 mm	a = 90 mm	a = 110 mm	a = 130 mm
	tk 5110-03			x	x
	tk 5110-04		x	x	x
	tk 5110-05	x	x	x	x
LED	tk 5111-03			x	x
LED	tk 5111-04		x	x	x
LED	tk 5111-05	x	x	x	x

Satz im Etui mit Griff rostfrei (Griff: tk 5143-07, Seite 25)
Set in case with handle stainless steel (handle: tk 5143-07, page 25)
Trousse à laryngoscopie en boîte avec manche inoxydable (manche: tk 5143-07, page 25)
Juego de laringoscopia, en caja, con mango inoxidable (mango: tk 5143-07, pagina 25)
Astuccio da laringoscopia, in cassetta, manico inossidabile (manico: tk 5143-07, pagina 25)

	tk 5110-11	tk 5110-12	tk 5110-13
Etui für Mc Intosh, leer Case for Mc Intosh, empty	für 3 Spatel for 3 blades	für 4 Spatel for 4 blades	für 5 Spatel for 5 blades
Etui pour Mc Intosh, vide Estuche para Mc Intosh, vacío Astuccio per Mc Intosh, vuoto	pour 3 spatules para 3 espátulas per 3 spatole	pour 4 spatules para 4 espátulas per 4 spatole	pour 5 spatules para 5 espátulas per 5 spatole



**Steriliser-Information: Alle Spatel können bis 134 °C im Autoklaven sterilisiert werden (ohne Lampe).
Sterilizing information: All blades are autoclavable up to 134 °C (without lamp).**

Information pour la stérilisation: Toutes les spatules peuvent être stérilisées jusqu'à 134 °C dans l'autoclave (sans Lampe).
Información para la esterilización: Todas las espátulas pueden ser esterilizadas en el autoclave a 134 °C (sin Bombilla).
Informazione per la sterilizzazione: Tutte le spatole possono essere sterilizzate nell'autoclave fino a 134 °C (senza lampadina).

**Laryngoskope
Laryngoscopes**
**Laryngoscopes
Laringoscopios
Laringoscopi**

MILLER

	Fig. 0	Fig. 1	Fig. 2	Fig. 3	Fig. 4
	a = 55 mm	a = 80 mm	a = 130 mm	a = 170 mm	a = 180 mm
	tk 5120-00	tk 5120-01	tk 5120-02	tk 5120-03	tk 5120-04
LED	tk 5220-00	tk 5220-01	tk 5220-02	tk 5220-03	tk 5220-04

rostfrei
stainless steel

inoxydable

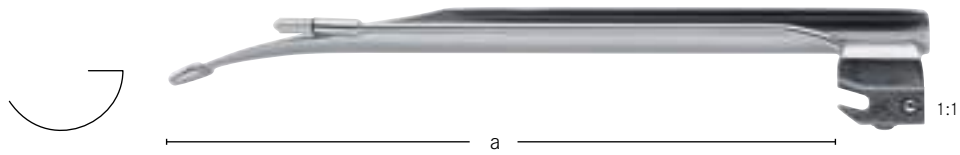
inoxidable

inossidabile



	Fig. 0	Fig. 1	Fig. 2	Fig. 3	Fig. 4
	tk 5145-02	tk 5145-02	tk 5145-01	tk 5145-01	tk 5145-01
LED	tk 5146-01	tk 5146-01	tk 5146-01	tk 5146-01	tk 5146-02

Ersatzlampe
Spare lamp

Lampe de rechange

Bombilla de sustitución

Lampadina di ricambio

		Fig. 0	Fig. 1	Fig. 2	Fig. 3	Fig. 4
		a = 55 mm	a = 80 mm	a = 130 mm	a = 170 mm	a = 180 mm
	tk 5121-03		x	x	x	
	tk 5121-04		x	x	x	x
	tk 5121-05	x	x	x	x	x
LED	tk 5122-03		x	x	x	
LED	tk 5122-04		x	x	x	x
LED	tk 5122-05	x	x	x	x	x

Satz im Etui mit Griff rostfrei (Griff: tk 5143-07, Seite 25)
Set in case with handle stainless steel (handle: tk 5143-07, page 25)

Trousse à laryngoscopie en boîte avec manche inoxydable (manche: tk 5143-07, page 25)

Juego de laringoscopia, en caja, con mango inoxidable (mango: tk 5143-07, pagina 25)

Astuccio da laringoscopia, in cassetta, manico inossidabile (manico: tk 5143-07, pagina 25)

	tk 5121-11	tk 5121-12	tk 5121-13
Etui für Miller, leer	für 3 Spatel	für 4 Spatel	für 5 Spatel
Case for Miller, empty	for 3 blades	for 4 blades	for 5 blades
Etui pour Miller, vide	pour 3 spatules	pour 4 spatules	pour 5 spatules
Estuche para Miller, vacío	para 3 espátulas	para 4 espátulas	para 5 espátulas
Astuccio per Miller, vuoto	per 3 spatole	per 4 spatole	per 5 spatole

Sterilisier-Information: Alle Spatel können bis 134 °C im Autoklaven sterilisiert werden (ohne Lampe).
Sterilizing information: All blades are autoclavable up to 134 °C (without lamp).

Information pour la stérilisation: Toutes les spatules peuvent être stérilisées jusqu'à 134 °C dans l'autoclave (sans Lampe).

Información para la esterilización: Todas las espátulas pueden ser esterilizadas en el autoclave a 134 °C (sin Bombilla).

Informazione per la sterilizzazione: Tutte le spatole possono essere sterilizzate nell'autoclave fino a 134 °C (senza lampadina).

Laryngoskop-Griffe
Laryngoscope handles

Manches pour laryngoscopes
Mangos de laringoscopios
 Manici per laringoscopi



tk 5140-07

verchromt
chrome plated
 chromé
cromado
 cromato

tk 5142-07

rostfrei
stainless steel
 inoxydbale
inoxidable
 inossidabile

1:1



tk 5141-07

verchromt
chrome plated
 chromé
cromado
 cromato

tk 5143-07

rostfrei
stainless steel
 inoxydbale
inoxidable
 inossidabile

1:1



Alle Griffe sind nur in Gas sterilisierbar oder in einer Lösung zu desinfizieren. Keine Sterilisation in Autoklaven und Heissluft. In jedem Fall vorher den Akkumulator oder den Batteriecontainer entnehmen. Passen für Spatel abgebildet auf S. 23/24.

All handles are only sterilizable in a gassterilizer or can be cleaned in a disinfection solution. Not autoclavable and no sterilisation in hot-air. Akkumulator or battery housing must be taken off before. To use with spatulas illustrated on pages 23/24

Toutes les poignées sont stérilisées uniquement en gaz ou désinfectés en solution. Ne pas autoclaver ou stériliser à l'air chaud. En tout cas enlevé avant l'accumulateur ou le conteneur de batterie. Spatule recommandée indiqué à la page 23/24.

Todos los mangos son esterilizados solo en gas o desinfectados en solución. No esterilizar en autoclave o aire caliente. En cualquier caso retirar antes el acumulador o el recipiente de la batería. Recomendados para espátula se muestran en la página 23/24..

Tutti i manici possono essere sterilizzati solamente con gas oppure disinfettati in una soluzione. Non sterilizzabili in autoclave ed aria calda. In ogni caso antepima si deve prelevare l'accumulatore oppure il contenitore delle batterie. Adattabili con le spatole che sono illustrate sulle pagine 23/24.

Laryngoskope – Kaltlicht
Laryngoscopes – Cold light

Laryngoscopes – lumière froide
Laringoscopios – luz fría
Laringoscopi – luce fredda

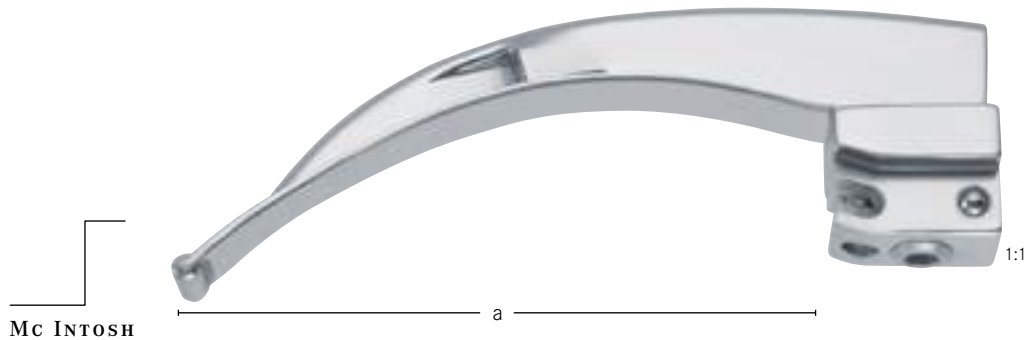

Fig. 0	Fig. 1	Fig. 2	Fig. 3	Fig. 4	Fig. 5
a = 55 mm	a = 70 mm	a = 90 mm	a = 110 mm	a = 130 mm	a = 150 mm
tk 5150-00	tk 5150-01	tk 5150-02	tk 5150-03	tk 5150-04	tk 5150-05

rostfrei
stainless steel
inoxydable
inoxidable
inossidabile



	Fig.0	Fig.1	Fig.2	Fig.3	Fig.4
	a = 55 mm	a = 70 mm	a = 90 mm	a = 110 mm	a = 130 mm
tk 5151-03			x	x	x
tk 5151-04		x	x	x	x
tk 5151-05	x	x	x	x	x

Satz im Etui mit Griff rostfrei (Griff: tk 5176-09, Seite 29)

Set in case with handle stainless steel (handle: tk 5176-09, page 29)

Trousse à laryngoscopie en boîte avec manche inoxydable (manche: tk 5176-09, page 29)

Juego de laringoscopia, en caja, con mango inoxidable (mango: tk 5176-09, pagina 29)

Astuccio da laringoscopia, in cassetta, manico inossidabile (manico: tk 5176-09, pagina 29)



Sterilisier-Information: Alle Spatel können bis 134 °C im Autoklaven sterilisiert werden.

Sterilizing information: All blades are autoclavable up to 134 °C.

Information pour la stérilisation: Toutes les spatules peuvent être stérilisées jusqu'à 134 °C dans l'autoclave.

Información para la esterilización: Todas las espátulas pueden ser esterilizadas en el autoclave a 134 °C.

Informazione per la sterilizzazione: Tutte le spatole possono essere sterilizzate nell'autoclave fino a 134 °C.

Laryngoskope – Kaltlicht
Laryngoscopes – Cold light

Laryngoscopes – lumière froide
Laringoscopios – luz fría
Laringoscopi – luce fredda

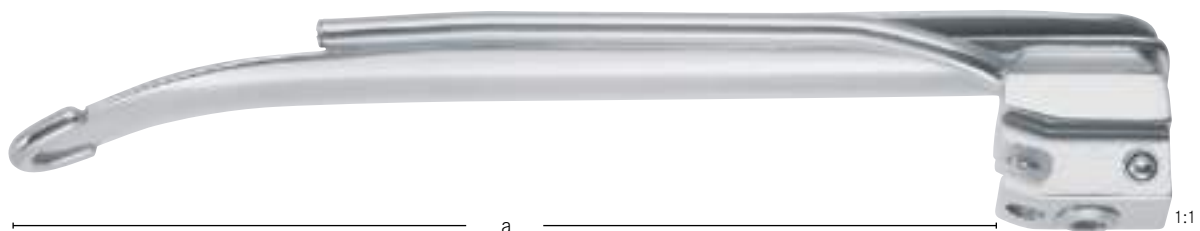
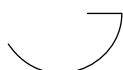

MILLER

Fig. 0	Fig. 1	Fig. 2	Fig. 3	Fig. 4
a = 55 mm	a = 80 mm	a = 130 mm	a = 170 mm	a = 180 mm
tk 5160-00	tk 5160-01	tk 5160-02	tk 5160-03	tk 5160-04

rostfrei
stainless steel
inoxydable
inoxidable
inossidabile



	Fig. 0	Fig. 1	Fig. 2	Fig. 3	Fig. 4
	a = 55 mm	a = 80 mm	a = 130 mm	a = 170 mm	a = 180 mm
tk 5161-03		x	x	x	
tk 5161-04		x	x	x	x
tk 5161-05	x	x	x	x	x

Satz im Etui mit Griff rostfrei (Griff: tk 5176-09, Seite 29)

Set in case with handle stainless steel (handle: tk 5176-09, page 29)

Trousse à laryngoscopie en boîte avec manche inoxydable (manche: tk 5176-09, page 29)

Juego de laringoscopia, en caja, con mango inoxidable (mango: tk 5176-09, pagina 29)

Astuccio da laringoscopia, in cassetta, manico inossidabile (manico: tk 5176-09, pagina 29)



Sterilisier-Information: Alle Spatel können bis 134 °C im Autoklaven sterilisiert werden.

Sterilizing information: All blades are autoclavable up to 134 °C.

Information pour la stérilisation: Toutes les spatules peuvent être stérilisées jusqu'à 134 °C dans l'autoclave.

Información para la esterilización: Todas las espátulas pueden ser esterilizadas en el autoclave a 134 °C.

Informazione per la sterilizzazione: Tutte le spatole possono essere sterilizzate nell'autoclave fino a 134 °C.

Laryngoskop-Griffe – Kaltlicht
Laryngoscope handles – Cold light

Manche pour laryngoscopes – lumière froide
Mangos de laringoscopios – luz fría
 Manici per laringoscopi – luce fredda

_____ a _____



MC INTOSH

Fig. 3	Fig. 4
a = 140 - 170 mm	a = 160 - 190 mm
tk 5162-03	tk 5162-04

MC INTOSH Kaltlicht-Laryngoskopspatel mit verstellbarer Spitze (Griff: tk 5175-09, tk 5176-09, tk 5176-10, Seite 29)
 MC INTOSH cold light laryngoscope blade with adjustable tip (handle: tk 5175-09, tk 5176-09, tk 5176-10, page 29)

MC INTOSH spatule pour laryngoscope lumière froide avec pointe ajustable (manche: tk 5175-09, tk 5176-09, tk 5176-10, page 29)
 MC INTOSH hoja para laringoscopio luz fría con punta ajustable (mango: tk 5175-09, tk 5176-09, tk 5176-10, pagina 29)

MC INTOSH lama per laringoscopio luce fredda con punta regolabile (manico: tk 5175-09, tk 5176-09, tk 5176-10, pagina 29)

Laryngoskop-Griffe – Kaltlicht
Laryngoscope handles – Cold light

Manche pour laryngoscopes – lumière froide
Mangos de laringoscopios – luz fría
 Manici per laringoscopi – luce fredda



1:2

tk 5175-09

Griff mit Batteriecontainer und Halogen-Lampe
Handle with battery container and halogen lamp

Manche avec conteneur à pile et lampe halogène
Mango con contenedor para pilas, luz halogeno
 Manico con contenitore per pila, lampada alogena



1:2

tk 5176-09

Griff mit Batteriecontainer und Xenon-Lampe
Handle with battery container and xenon lamp

Manche avec conteneur à pile et lampe xenon
Mango con contenedor para pilas, luz xenon
 Manico con contenitore per pila, luce xenon



1:2

tk 5176-10

Griff mit Batteriecontainer und LED-Lampe
Handle with battery container and LED lamp

Manche avec conteneur à pile et lampe LED
Mango con contenedor para pilas, luz LED
 Manico con contenitore per pila, lampada LED



Alle Griffe sind nur in Gas sterilisierbar oder in einer Lösung zu desinfizieren. Keine Sterilisation in Autoklaven und Heissluft. In jedem Fall vorher den Akkumulator oder den Batteriecontainer entnehmen. Passen für Spatel abgebildet auf S. 26/28.
All handles are only sterilizable in a gassterilizer or can be cleaned in a disinfection solution. Not autoclavable and no sterilisation in hot-air. Akkumulator or battery housing must be taken off before. To use with spatulas illustrated on pages 26/28

Toutes les poignées sont stérilisées uniquement en gaz ou désinfectés en solution. Ne pas autoclaver ou stériliser à l'air chaud. En tout cas enlevé avant l'accumulateur ou le conteneur de batterie. Spatule recommandée indiqué à la page 26/28.

Todos los mangos son esterilizados solo en gas o desinfectados en solución. No esterilizar en autoclave o aire caliente. En cualquier caso retirar antes el acumulador o el recipiente de la batería. Recomendados para espátula se muestran en la página 26/28.

Tutti i manici possono essere sterilizzati solamente con gas oppure disinfettati in una soluzione. Non sterilizzabili in autoclave ed aria calda. In ogni caso antepima si deve prelevare l'accumulatore oppure il contenitore delle batterie. Adattabili con le spatole che sono illustrate sulle pagine 26/28.

Laryngoskop-Ersatzlampe
Laryngoscope-spare lamp

Laryngoscope-lampe de rechange
Laringoscopio-bombilla de cambio
 Laringoscopio-lampadina di ricambio



2.5V / 1.9 W	3.6V / 2.1 W
tk 5186-04	tk 5186-06

für Batteriehandgriffe
for battery

pour de piles
para de pilas
 per manici a pila

Xenon Ersatzlampen, 1 Packung à 6 Stück
Xenon spare lamps, pack of 6 pieces

Xenon lampe de rechange, jeu de 6 pièces
Xenon bombilla de cambio, juego de 6 piezas

Lampadina di ricambio Xenon, confezione da 6 pezzi

für Akkuhandgriffe

for accumulator handles

pour poignées d'accumulateurs
para mangos de acumuladores
 per manici d'accumulatore



2.5V / 1.8 W

tk 5187-04

Halogen Ersatzlampe
Halogen spare lamp

Halogéne lampe de rechange
Halogeno bombilla de cambio
 Lampadina di ricambio alogena



2.5V / 1.3 W

tk 5146-02

LED Ersatzlampe
LED spare lamp

LED lampe de rechange
LED bombilla de cambio
 Lampadina di ricambio LED

Laryngoskop-Griffe – Kaltlicht
Laryngoscope handles – Cold light

Manche pour laryngoscopes – lumière froide
Mangos de laringoscopios – luz fría
 Manici per laringoscopi – luce fredda



1:2

tk5176-11

Wiederaufladbarer Griff mit Batteriecontainer und LED Leuchtmittel

Rechargeable handle with battery container and LED lamp

Rechargeable manche avec conteneur de piles et lampe LED

Rechargeable mango con contenedor de pilas y bombilla e LED

Ricaricabile manico con contenitore di pila e lampada LED

tk5176-12

Ladestation für 5176-11 230 Volt

Charging station for 5176-11 230 volt

Station de charge pour 5176-11 230 volt

Estación de carga para 5176-11 230 voltio

Stazione di ricarica per 5176-11 230 volt

**tk5176-13**

Ladestation für 5176-11 115 Volt

Charging station for 5176-11 115 volt

Station de charge pour 5176-11 115 volt

Estación de carga para 5176-11 115 voltio

Stazione di ricarica per 5176-11 115 volt

Laryngoskope
Laryngoscopes

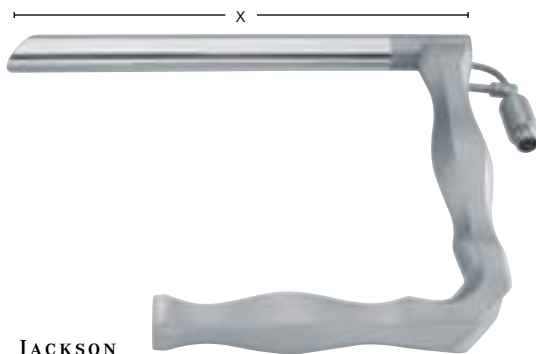
 Laryngoscopes
Laringoscopios
 Laringoscopi

JACKSON

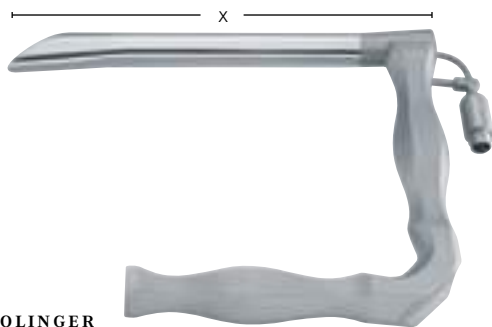
	x = 120 mm	x = 170 mm	x = 180 mm
	tk 5190-01	tk 5190-02	tk 5190-03
Jackson mit Lichtträger, rostfrei <i>Jackson with light carrier, stainless steel</i> Jackson avec porte de lumière, inoxydable <i>Jackson con porta fibras, inoxidable</i> Jackson con porta luce, inossidabile	für Säuglinge <i>for babys</i> pour nourissons <i>para lactantes</i> per lattanti	für Kinder <i>for children</i> pour enfants <i>para niños</i> per bambini	für Erwachsene <i>for adults</i> pour adultes <i>para adultos</i> per adulti
	x = 120 mm	x = 170 mm	x = 180 mm
	tk 5191-01	tk 5191-02	tk 5191-03
Lichtträger, allein, für Jackson <i>Light carrier, only, for Jackson</i> Porte de lumière, seul, pour Jackson <i>Porta fibras, sola, para Jackson</i> Porta luce, sola, per Jackson	für Säuglinge <i>for babys</i> pour nourissons <i>para lactantes</i> per lattanti	für Kinder <i>for children</i> pour enfants <i>para niños</i> per bambini	für Erwachsene <i>for adults</i> pour adultes <i>para adultos</i> per adulti

HOLINGER

	x = 171 mm	x = 180 mm
	tk 5195-01	tk 5195-02
Holinger mit Lichtträger, rostfrei <i>Holinger with light carrier, stainless steel</i> Holinger avec porte de lumière, inoxydable <i>Holinger con porta fibras, inoxidable</i> Holinger con porta luce, inossidabile		
	x = 171 mm	x = 180 mm
	tk 5196-01	tk 5196-02
Lichtträger, allein, für Holinger <i>Light carrier, only, for Holinger</i> Porte de lumière, seul, pour Holinger <i>Porta fibras, sola, para Holinger</i> Porta luce, solo, per Holinger		

Operationslaryngoskope
Operation laryngoscopes

Laryngoscopes pour interventions chirurgicales
Laringoscopios para operaciones
Laringoscopi per l'intervento chirurgico



Fig. 1

x = 135 mm **tk 5250-01**

Rostfreier Edelstahl
Stainless steel
Acier inoxydable
Acero inoxidable
Acciaio inossidabile

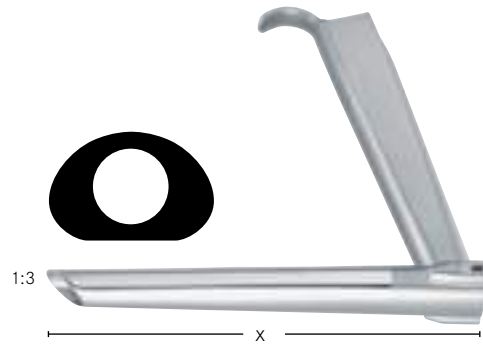

Fig. 2

x = 152 mm **tk 5250-02**

Rostfreier Edelstahl
Stainless steel
Acier inoxydable
Acero inoxidable
Acciaio inossidabile



Fig. 3

x = 182 mm **tk 5250-03**

Rostfreier Edelstahl
Stainless steel
Acier inoxydable
Acero inoxidable
Acciaio inossidabile



Fig. 4

x = 172 mm **tk 5250-04**

Rostfreier Edelstahl
Stainless steel
Acier inoxydable
Acero inoxidable
Acciaio inossidabile

Operationslaryngoskope
Operation laryngoscopes

Laryngoscopes pour interventions chirurgicales
Laringoscopios para operaciones
Laringoscopi per l'intervento chirurgico

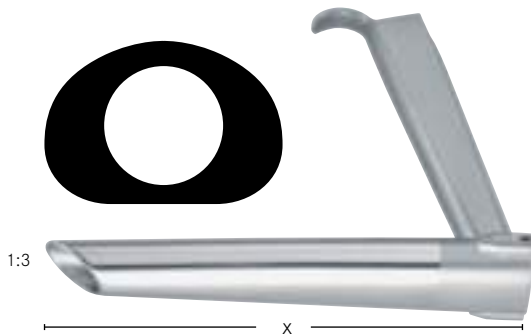

Fig. 5

x = 172 mm | **tk 5250-05**

Rostfreier Edelstahl
Stainless steel
Acier inoxydable
Acero inoxidable
Acciaio inossidabile



Fig. 6

x = 182 mm | **tk 5250-06**

Rostfreier Edelstahl
Stainless steel
Acier inoxydable
Acero inoxidable
Acciaio inossidabile

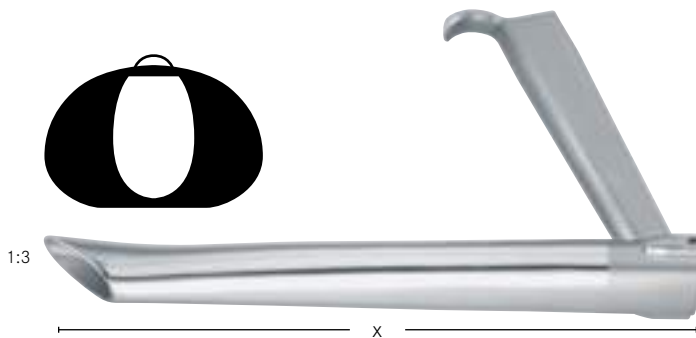

Fig. 7

x = 222 mm | **tk 5250-07**

Rostfreier Edelstahl
Stainless steel
Acier inoxydable
Acero inoxidable
Acciaio inossidabile



340 mm – 13" | **tk 5251-00**

Bruststütze mit Stützstange für Erwachsene
Chest-support with support-rod for adults
Appui-poitrine avec tige pour adultes
Soporte de pecho con vara para adultos
Supporto per petto con asta per adulti

1:3

240 mm – 9" | **tk 5251-50**

Stützstange für Kinder
Support-rod for children
Tige pour enfants
Vara para niños
Asta per bambini

Zubehör für OP-Laryngoskope
Accessories for Operation laryngoscopes

Accessoires pour laryngoscopes chirurgicaux
Accesorios para laringoscopios quirúrgicos
 Accessori per laringoscopi di operazione

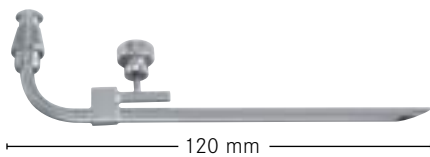

tk 5258-00

Injektionskanüle für Laryngoskope tk 5250-01 – tk 5250-07
Injections drain tube for laryngoscopes tk 5250-01 – tk 5250-07

Canule à injection pour laryngoscopes tk 5250-01 – tk 5250-07
Canula de inyección para laringoscopios tk 5250-01 – tk 5250-07
 Cannula d'iniezione per laringoscopi tk 5250-01 – tk 5250-07

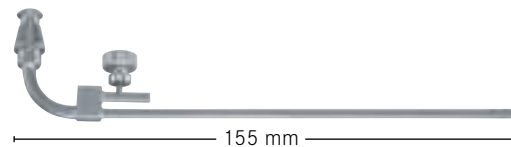

tk 5260-00

Rauchabsaugrohr für Laryngoskope tk 5250-03 – tk 5250-07
Suction tube for laryngoscopes tk 5250-03 – tk 5250-07

Tube d'aspiration pour laryngoscopes tk 5250-03 – tk 5250-07
Tubo de aspiración para laringoscopios tk 5250-03 – tk 5250-07
 Tubo d'aspirazione per laringoscopi tk 5250-03 – tk 5250-07

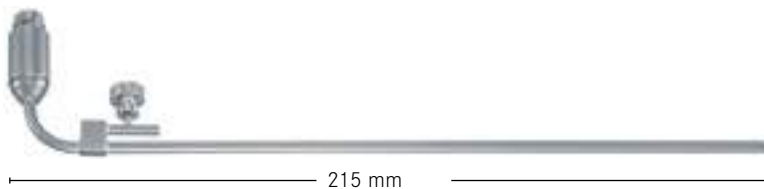

tk 5256-00

für Laryngoskop tk 5250-07
for laryngoscope tk 5250-07

pour laryngoscope tk 5250-07
para laringoscopio tk 5250-07
 per laringoscopio tk 5250-07

Zubehör für OP-Laryngoskope
Accessories for Operation laryngoscopes

Accessoires pour laryngoscopes chirurgicaux
Accesorios para laringoscopios quirúrgicos
Accessori per laringoscopi di operazione

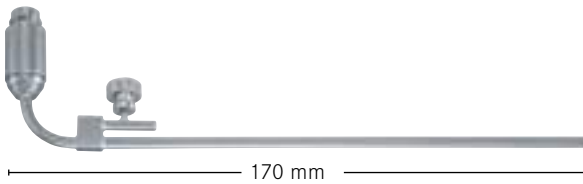

tk 5254-00

für Laryngoskope tk 5250-03 – tk 5250-06
for laryngoscopes tk 5250-03 – tk 5250-06
pour laryngoscopes tk 5250-03 – tk 5250-06
para laringoscopios tk 5250-03 – tk 5250-06
per laringoscopi tk 5250-03 – tk 5250-06

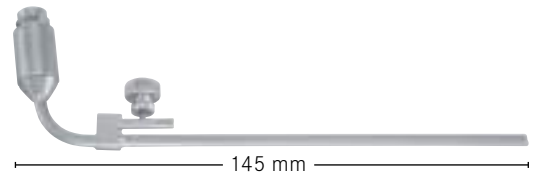

tk 5252-00

für Laryngoskope tk 5250-01 – tk 5250-02
for laryngoscopes tk 5250-01 – tk 5250-02
pour laryngoscopes tk 5250-01 – tk 5250-02
para laringoscopios tk 5250-01 – tk 5250-02
per laringoscopi tk 5250-01 – tk 5250-02



tk 5260-01

Rauchabsaugrohr für Laryngoskope tk 5250-01 – tk 5250-02
Suction tube for laryngoscopes tk 5250-01 – tk 5250-02
Tube d'aspiration pour laryngoscopes tk 5250-01 – tk 5250-02
Tubo de aspiración para laringoscopios tk 5250-01 – tk 5250-02
Tubo d'aspirazione per laringoscopi tk 5250-01 – tk 5250-02



Aspiration, Sonden
Aspiration, Probes

Aspiration, Sondes
Aspiración, Sondas
Aspirazione, Sonde

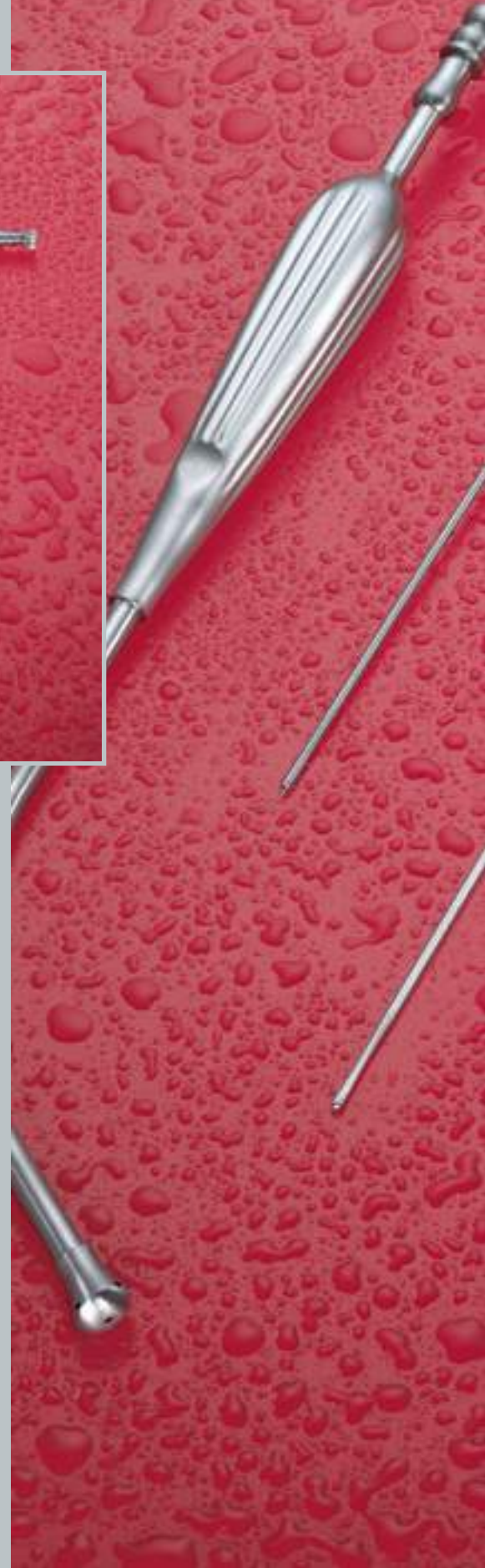

Trokare | Trocarts
Trocars | Trócares
Trequarti



1:1

1:1

UNIVERSAL

	Fig. 1	Fig. 2	Fig. 3	Fig. 4
	6.0 mm Ø	4.5 mm Ø	3.0 mm Ø	1.75 mm Ø
tk 6111-03		x	x	x
tk 6111-04	x	x	x	x

Satz
Set
Jeu
Juego
Serie



1:1

1:1

1:1

1:1

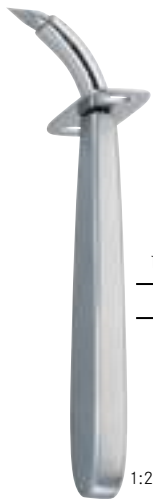

1:2

UCKERMANN

130 mm - 5" | **tk 6163-13**

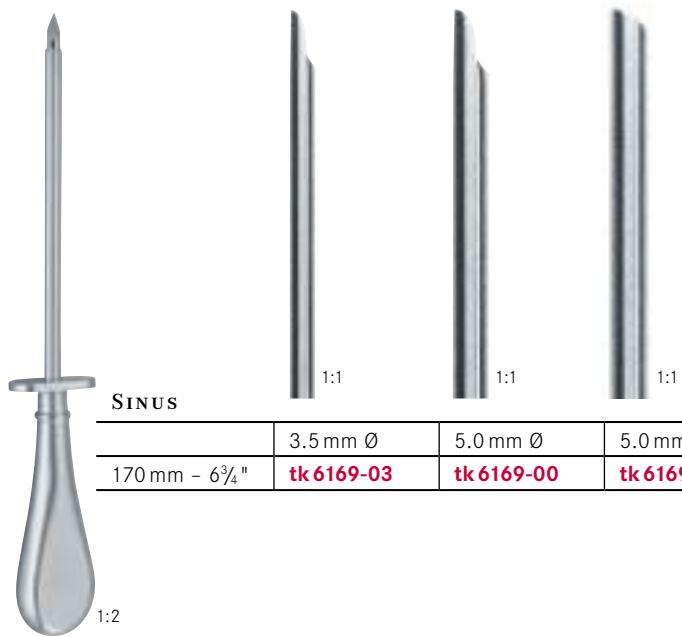

1:2

SINUS

	3.5 mm Ø	5.0 mm Ø	5.0 mm Ø
170 mm - 6¾"	tk 6169-03	tk 6169-00	tk 6169-05

1:1

1:1

1:1

Trokare
Trocars
Trequarti

Trocarts
Trócares
Trequarti



1:2

LICHTWITZ

	1.8 mm Ø	2.0 mm Ø
190 mm - 7½"	tk 6170-19	tk 6171-15

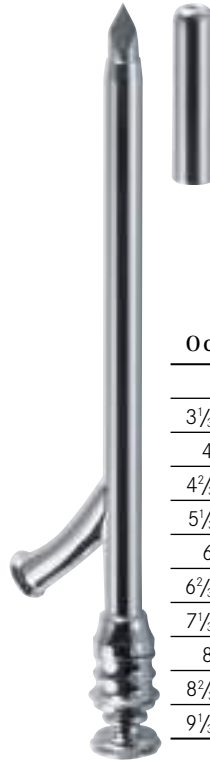

OCHSNER

		100 mm - 4"
3½ mm Ø	10 Char./Fr.	tk 6190-10
4 mm Ø	12 Char./Fr.	tk 6190-12
4½ mm Ø	14 Char./Fr.	tk 6190-14
5½ mm Ø	16 Char./Fr.	tk 6190-16
6 mm Ø	18 Char./Fr.	tk 6190-18
6½ mm Ø	20 Char./Fr.	tk 6190-20
7½ mm Ø	22 Char./Fr.	tk 6190-22
8 mm Ø	24 Char./Fr.	tk 6190-24
8½ mm Ø	26 Char./Fr.	tk 6190-26
9½ mm Ø	28 Char./Fr.	tk 6190-28



1:2

NELSON

	6.0 mm Ø	8.3 mm Ø	9.5 mm Ø	11.6 mm Ø
210 mm - 8¼"	tk 6175-01	tk 6175-02	tk 6175-03	tk 6175-04

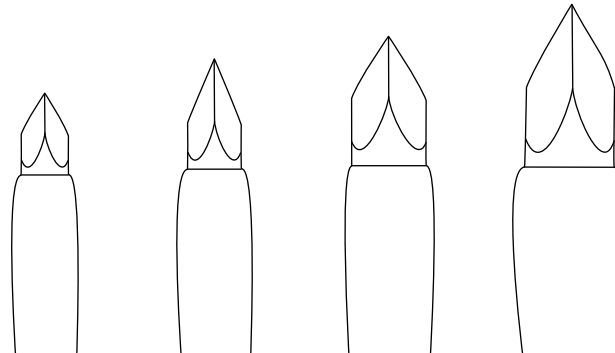

Trokare
Trocars
Trequarti



LANDAU

	2 mm Ø
160 mm - 6¼"	tk 6210-16



PIERCE

	170 mm - 6¾"
3 mm Ø	tk 6225-03
4 mm Ø	tk 6225-04
5 mm Ø	tk 6225-05



KRAUSE

	5.5 mm Ø
150 mm - 6"	tk 6230-15



COAKLEY

	2.25 mm Ø
160 mm - 6¼"	tk 6235-16

Saugrohre
Suction tubes

Canules d'aspiration
Tubos de aspiración
Tubi per aspirazione



COOLEY

1:3

	8 mm Ø
350 mm - 13 3/4"	tk 6291-35



1:3

	10 mm Ø
310 mm - 12 1/4"	tk 6292-31



1:3

	6 mm Ø
300 mm - 12"	tk 6293-30



1:3

	8 mm Ø
330 mm - 13"	tk 6294-33

Saugrohre
Suction tubes

Canules d'aspiration
Tubos de aspiración
Tubi per aspirazione



POOLE

		220 mm - 8"
8 mm Ø	23 Charrr./Fr.	tk 6308-22



POOLE

		220 mm - 8"
10 mm Ø	30 Charrr./Fr.	tk 6310-22



ANDREWS-PYNCHON

235 mm - 9 1/4"	tk 6320-23
-----------------	-------------------



DE BAKEY

275 mm - 10 3/4"	tk 6325-27
------------------	-------------------



YANKAUER

270 mm - 10 3/4"	tk 6350-27
------------------	-------------------

Ohrkatheter
Eustachian catheters

Sondes auriculaires
Sondas auriculares
Sonde auricolari



HARTMANN

	Fig. 1	Fig. 2
2.0 mm Ø	tk 6361-20	tk 6363-20
2.5 mm Ø	tk 6361-25	tk 6363-25
3.0 mm Ø	tk 6361-30	tk 6363-30



KILLIAN

○	160 mm - 6"	2.5 mm Ø	tk 6371-16
●	160 mm - 6"	3.0 mm Ø	tk 6372-16

ovale Öffnung
oval opening

ouverture ovale
apertura oval
apertura ovale



HARTMANN

	Fig. 0	Fig. 1	Fig. 2	Fig. 3	Fig. 4	Fig. 5
150 mm - 6"	tk 6380-00	tk 6380-01	tk 6380-02	tk 6380-03	tk 6380-04	tk 6380-05

Ohrkatheter
Eustachian catheters

Sondes auriculaires
Sondas auriculares
Sonde auricolari

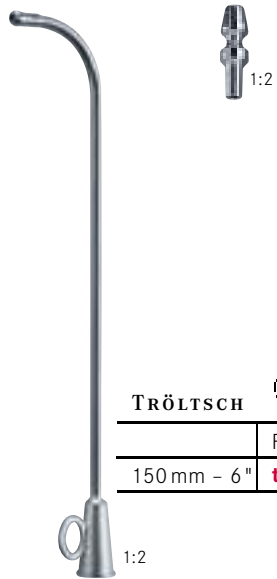

tk 6385-00

Schlaucholive für Ohrkatheter
Tube end piece for eustachian catheter
Olive pour sonde auriculaire
Olive para sondas auriculares
Olive per sonde auricolari

TRÖLTSCH



1:1



1:1



1:1



1:1



1:1

	Fig. 1	Fig. 2	Fig. 3	Fig. 4	Fig. 5
150 mm - 6"	tk 6382-01	tk 6382-02	tk 6382-03	tk 6382-04	tk 6382-05

Ohrspritze
Ear syringe

Seringue auriculaire
Jeringa auricular
Siringhe auricolari



1:2



1:2



1:2



1:2



1:2

tk 6376-00	tk 6376-10	tk 6376-05	tk 6376-07	tk 6376-08	tk 6376-09
50 ccm 2 oz	100 ccm 4 oz				

tk 6375-00	x		x	x	x
tk 6375-10		x	x	x	

komplett
complete
complet
completa
completa

Saug- und Spülkanülen
Suction and irrigation cannulas

Canules pour aspiration et lavage
Canulas para aspiracion y lavado
Cannule per aspirazione e lavaggio



1.2 mm Ø x 60 mm	tk 18130-01	tk 18131-01
1.5 mm Ø x 80 mm	tk 18130-02	tk 18131-02
2.0 mm Ø x 80 mm	tk 18130-03	tk 18131-03

Packung à 6 Stück
Package of 6 pieces
Paquet de 6 pièces
Paquete de 6 piezas
Confezione da 6 pezz

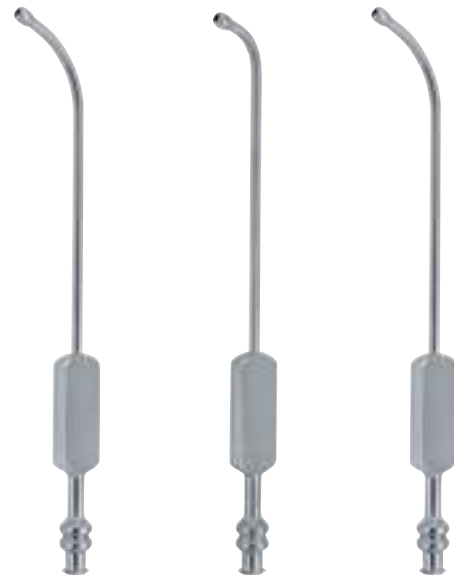

EICKEN

2.5 mm Ø	tk 6383-01	tk 6383-02	tk 6384-01
3.0 mm Ø	tk 6383-04	tk 6383-05	tk 6384-04

leicht gebogen <i>slightly curved</i>	stark gebogen <i>strongly curved</i>	biegsam <i>malleable</i>
légèrement courbé	très courbé	malléable
ligeramente curvada	muy curvada	maleable
leggermente curva	fortemente curva	malleabile



LUER-LOCK
3.0 mm Ø
tk 6381-00



LUER-LOCK
2.5 mm Ø
tk 6381-01



FISCH
4.0 mm Ø
tk 6381-02

Saug- und Spülkanülen
Suction and irrigation cannulas

Canules pour aspiration et lavage
Canulas para aspiracion y lavado
Cannule per aspirazione e lavaggio

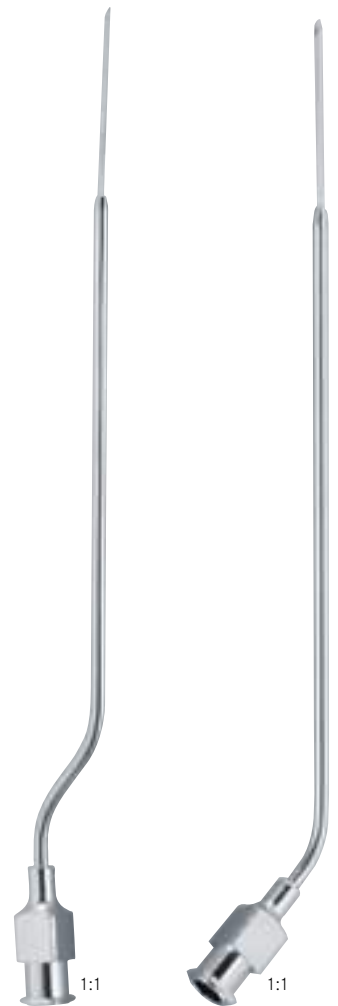
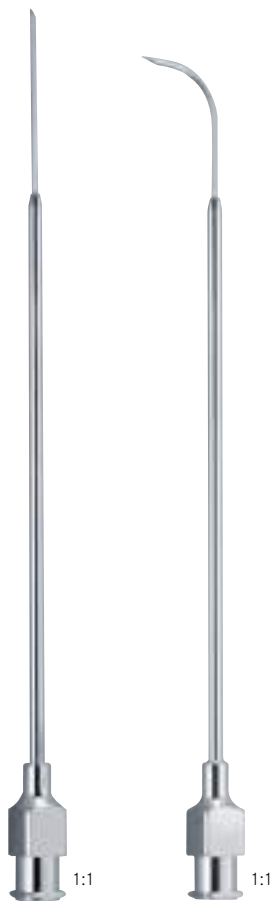

0.8 mm Ø	tk 6388-01	tk 6388-03
Tonsillenkanüle <i>Tonsil needle</i>	gerade <i>straight</i>	gebogen <i>curved</i>
Aiguille pour amygdales <i>Aguja para amigdales</i> Cannule per tonsille	droite <i>recta</i> retta	courbe <i>curva</i> curva

0.8 mm Ø	tk 6388-04	tk 6388-02
Septumkanüle <i>Septum needle</i>	bayonettförmig <i>bayonet</i>	abgewinkelt <i>angled on flat</i>
Aiguille pour le cloison nasal <i>Aguja para el tabique nasal</i> Ago per setto nasale	baïonette <i>bayoneta</i> baionetta	coudé sur le plat <i>angulado</i> angolato

Saugrohre
Suction tubes

Tubes d'aspiration
Tubos para aspiración
Cannule d'aspirazione

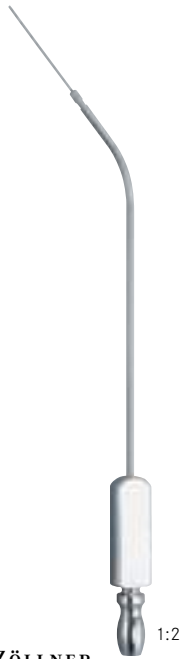

ZÖLLNER

0.7 mm Ø

tk 25221-00

komplett mit 1 aufsetzbaren Kanüle, 0.7 mm Ø
complete with 1 slip-on cannula, 0.7 mm Ø
complet avec 1 canule démontable, 0.7 mm de Ø
completo con 1 cánula desmontable de 0.7 mm Ø
completa di 1 cannula applicabile di mm 0.7 di Ø



MOCK

	2.9 mm Ø
65 mm - 2½"	tk 6555-06



IOWA

	0.7 mm Ø
160 mm - 6¼"	tk 25223-16



MAGILL

	245 mm - 9¾"
3.0 mm Ø	tk 25225-01
3.5 mm Ø	tk 25225-02
4.0 mm Ø	tk 25225-03

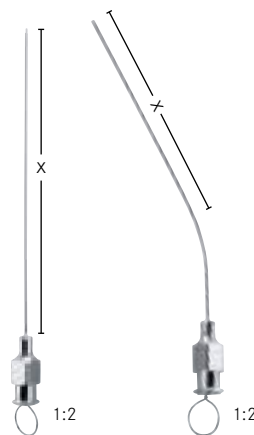

ROSEN

	x = 80 mm	x = 65 mm
0.7 mm Ø	tk 25243-01	tk 25244-01
0.9 mm Ø	tk 25243-02	tk 25244-02
1.2 mm Ø	tk 25243-03	tk 25244-03

Saugrohre
Suction tubes

Tubes d'aspiration
Tubos para aspiración
Cannule d'aspirazione



BARON

		x = 75 mm - 3"	x = 100 mm - 4"
1 mm Ø	3 Charr./Fr.	tk 25226-03	tk 25226-53
1 2/3 mm Ø	5 Charr./Fr.	tk 25226-05	tk 25226-55
2 1/3 mm Ø	7 Charr./Fr.	tk 25226-07	tk 25226-57

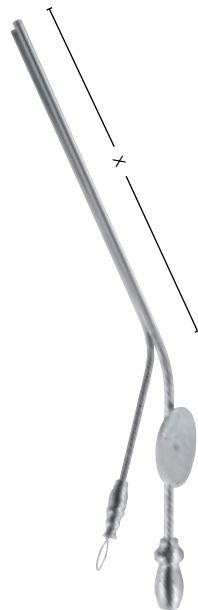

HOUSE

		x = 75 mm - 3"	x = 100 mm - 4"
1 mm Ø	3 Charr./Fr.	tk 25227-53	tk 25227-03
1 2/3 mm Ø	5 Charr./Fr.	tk 25227-55	tk 25227-05
2 1/3 mm Ø	7 Charr./Fr.	tk 25227-57	tk 25227-07
2 2/3 mm Ø	8 Charr./Fr.	tk 25227-58	tk 25227-08
3 1/3 mm Ø	10 Charr./Fr.	tk 25227-60	tk 25227-10
4 mm Ø	12 Charr./Fr.	tk 25227-62	tk 25227-12
4 2/3 mm Ø	14 Charr./Fr.	tk 25227-64	tk 25227-14



FERGUSSON

		x = 120 mm - 4 3/4"
2 mm Ø	6 Charr./Fr.	tk 25228-06
2 1/3 mm Ø	7 Charr./Fr.	tk 25228-07
2 2/3 mm Ø	8 Charr./Fr.	tk 25228-08
3 mm Ø	9 Charr./Fr.	tk 25228-09
3 1/3 mm Ø	10 Charr./Fr.	tk 25228-10
4 mm Ø	12 Charr./Fr.	tk 25228-12
5 mm Ø	15 Charr./Fr.	tk 25228-15

1:2

Saugrohre
Suction tubes

Tubes d'aspiration
 Tubos para aspiración
 Cannule d'aspirazione



PLESTER

		170 mm - 6 ³ / ₄ "
2 mm Ø	6 Charr./Fr.	tk 25229-06
2 ¹ / ₃ mm Ø	7 Charr./Fr.	tk 25229-07
2 ² / ₃ mm Ø	8 Charr./Fr.	tk 25229-08
3 mm Ø	9 Charr./Fr.	tk 25229-09
3 ¹ / ₃ mm Ø	10 Charr./Fr.	tk 25229-10
3 ² / ₃ mm Ø	11 Charr./Fr.	tk 25229-11
4 mm Ø	12 Charr./Fr.	tk 25229-12
5 mm Ø	15 Charr./Fr.	tk 25229-15

1:2



ADSON

		210 mm - 8 ¹ / ₄ "
4 mm Ø	12 Charr./Fr.	tk 25235-04
5 mm Ø	15 Charr./Fr.	tk 25235-05

1:2



200 mm - 8" **tk 51645-20**

Saug-Raspatorium - biegsam, scharf
Suction raspatory - malleable, sharp

Rugine aspirante - flexible, tranchant

Legra aspiradora - maleable y agudo

Elevatore-aspiratore - flessibile, tagliente

1:2

Saugrohre
Suction tubes

Tubes d'aspiration
Tubos para aspiración
Cannule d'aspirazione



FRAZIER

		170 mm - 6¾"	170 mm - 6¾"	170 mm - 6¾"	170 mm - 6¾"	170 mm - 6¾"
2 mm Ø	6 Charr./Fr.	tk 25230-06				
2½ mm Ø	7 Charr./Fr.	tk 25230-07				
2⅔ mm Ø	8 Charr./Fr.	tk 25230-08				
3 mm Ø	9 Charr./Fr.	tk 25230-09				
3⅓ mm Ø	10 Charr./Fr.	tk 25230-10	tk 25220-02	tk 25220-01	tk 25220-06	tk 25220-05
4 mm Ø	12 Charr./Fr.	tk 25230-12	tk 25220-04	tk 25220-03	tk 25220-08	tk 25220-07
5 mm Ø	15 Charr./Fr.	tk 25230-15				

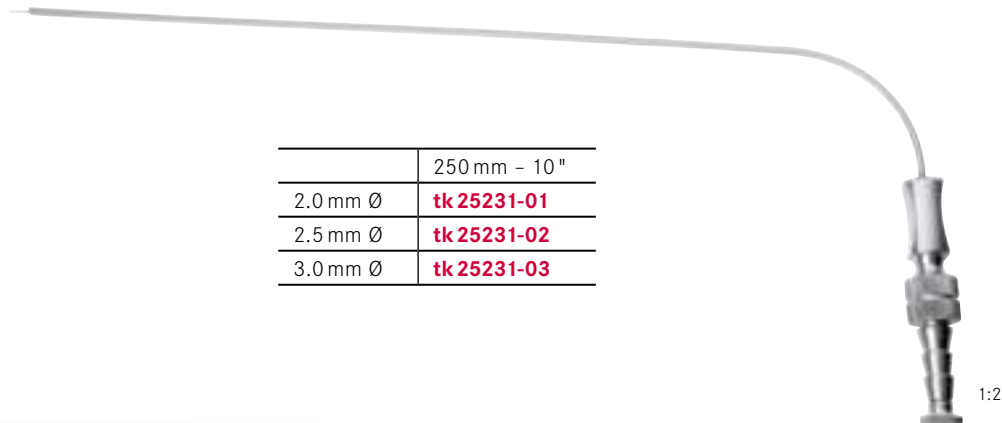

	250 mm - 10"
2.0 mm Ø	tk 25231-01
2.5 mm Ø	tk 25231-02
3.0 mm Ø	tk 25231-03

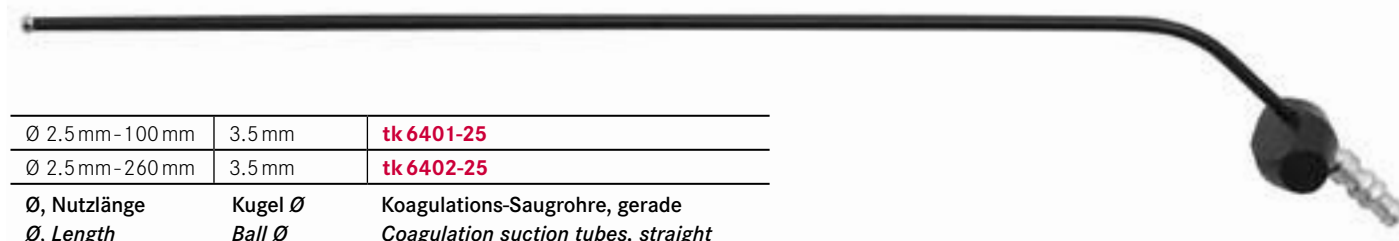

Ø 2.5 mm - 100 mm	3.5 mm	tk 6401-25
Ø 2.5 mm - 260 mm	3.5 mm	tk 6402-25

Ø, Nutzlänge Ø, Length	Kugel Ø Ball Ø	Koagulations-Saugrohre, gerade Coagulation suction tubes, straight
Ø, Longueur Ø, Longitud	Boule Ø Bola Ø	Canules de suction et coagulation, droits Canulas de succión et coagulación, rectas
Ø, Lunghezza operativa	Sfera Ø	Cannule di aspirazione e coagulazione, rette

Redon Führungsadeln
Guide needles

Aiguilles d'introduction
Agujas de guia
Aghi guida



		195 mm - 5 ³ / ₄ "
2 ² / ₃ mm Ø	8 Charr./Fr.	tk 6500-08
3 ¹ / ₃ mm Ø	10 Charr./Fr.	tk 6500-10
4 mm Ø	12 Charr./Fr.	tk 6500-12
4 ² / ₃ mm Ø	14 Charr./Fr.	tk 6500-14
5 ¹ / ₃ mm Ø	16 Charr./Fr.	tk 6500-16
6 mm Ø	18 Charr./Fr.	tk 6500-18

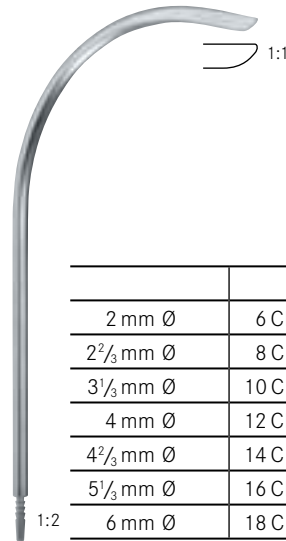

		195 mm - 5 ³ / ₄ "
2 mm Ø	6 Charr./Fr.	tk 6501-06
2 ² / ₃ mm Ø	8 Charr./Fr.	tk 6501-08
3 ¹ / ₃ mm Ø	10 Charr./Fr.	tk 6501-10
4 mm Ø	12 Charr./Fr.	tk 6501-12
4 ² / ₃ mm Ø	14 Charr./Fr.	tk 6501-14
5 ¹ / ₃ mm Ø	16 Charr./Fr.	tk 6501-16
6 mm Ø	18 Charr./Fr.	tk 6501-18

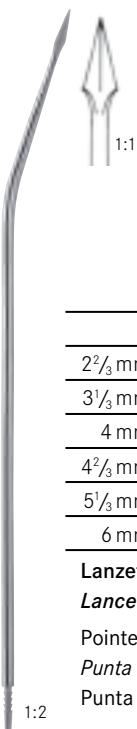

		195 mm - 5 ³ / ₄ "
2 ² / ₃ mm Ø	8 Charr./Fr.	tk 6502-08
3 ¹ / ₃ mm Ø	10 Charr./Fr.	tk 6502-10
4 mm Ø	12 Charr./Fr.	tk 6502-12
4 ² / ₃ mm Ø	14 Charr./Fr.	tk 6502-14
5 ¹ / ₃ mm Ø	16 Charr./Fr.	tk 6502-16
6 mm Ø	18 Charr./Fr.	tk 6502-18

Lanzettenspitze

Lancet tip

Pointe lancéolaire

Punta lanceolata

Punta lanceolata

Glas/Metall Spritzen
Glas/metal syringes

Seringues en verre/métal
Jeringas de vidrio/metal
Siringhe vetro/metallo



LUER

1 ml	tk 6700-01	tk 6701-01
2 ml	tk 6700-02	tk 6701-02
5 ml	tk 6700-05	tk 6701-05
10 ml	tk 6700-10	tk 6701-10
20 ml	tk 6700-20	tk 6701-20
50 ml	tk 6700-50	tk 6701-50

Spritze, komplett Zylinder
Syringe, complete Barrel
Seringue, complète Cylindre
Jeringa, completa Cilindro
Siringa, completa Cilindro

1:2



LUER-LOCK

1 ml	tk 6710-01	tk 6711-01
2 ml	tk 6710-02	tk 6711-02
5 ml	tk 6710-05	tk 6711-05
10 ml	tk 6710-10	tk 6711-10
20 ml	tk 6710-20	tk 6711-20
50 ml	tk 6710-50	tk 6711-50

Spritze, komplett Zylinder
Syringe, complete Barrel
Seringue, complète Cylindre
Jeringa, completa Cilindro
Siringa, completa Cilindro

1:2



1:2

LUER-LOCK

2 ml	tk 6780-02	tk 6781-02
5 ml	tk 6780-05	tk 6781-05
10 ml	tk 6780-10	tk 6781-10

Spritze, komplett Zylinder
Syringe, complete Barrel
Seringue, complète Cylindre
Jeringa, completa Cilindro
Siringa, completa Cilindro

tk 6782-02

Luer Lock Anschluß
Luer Lock attachment
Raccord Luer Lock
Conector Luer Lock
Raccordo Luer Lock



Ersatzteile und Zubehör auf Anfrage

Spare parts and accessories upon request

Pièces de rechange et accessoires sur demande

Piezas de cambio y accesorios según demanda

Pezzi di ricambio ed accessori a richiesta

Wund- und Blasenspritzen
Wound- and bladdersyringes

Seringues pour plaies et vessie
Jeringas para enjuagar vejiga y heridas
Siringhe per ferite e vescica



JANET

50 ml	tk 6750-01	tk 6751-01
75 ml	tk 6750-02	tk 6751-02
100 ml	tk 6750-03	tk 6751-03
150 ml	tk 6750-04	tk 6751-04
200 ml	tk 6750-05	tk 6751-05

Spritze, komplett	Zylinder, allein
Syringe, complete	Barrel, only
Seringue, complète	Cylindre, seul
Jeringa, completa	Cilindro, sola
Siringa, completa	Cilindro, solo

Sonden
Probes and directors

Sondes et stylets
Sondas y estiletas
Specilli e sonde



	2.0 mm Ø	1.5 mm Ø	1.0 mm Ø
115 mm - 4½"	tk 18100-11	tk 18101-11	tk 18102-11
130 mm - 5"	tk 18100-13	tk 18101-13	tk 18102-13
145 mm - 5¾"	tk 18100-14	tk 18101-14	tk 18102-14
160 mm - 6¼"	tk 18100-16	tk 18101-16	tk 18102-16
180 mm - 7"	tk 18100-18	tk 18101-18	tk 18102-18
200 mm - 8"	tk 18100-20	tk 18101-20	tk 18102-20
250 mm - 9¾"	tk 18100-25	tk 18101-25	tk 18102-25



2 mm Ø	
115 mm - 4½"	tk 18105-11
130 mm - 5"	tk 18105-13
145 mm - 5¾"	tk 18105-14
160 mm - 6¼"	tk 18105-16
180 mm - 7"	tk 18105-18
200 mm - 8"	tk 18105-20
250 mm - 9¾"	tk 18105-25



2 mm Ø	
115 mm - 4½"	tk 18108-11
130 mm - 5"	tk 18108-13
145 mm - 5¾"	tk 18108-14
160 mm - 6¼"	tk 18108-16

Myrtenblattsonde
myrtle-shaped

en forme de myrte
en forme de mirto
forma di mirto

mit Öhr
with eyelet
avec oeil
con ojo
con cruna



115 mm - 4½"	tk 18110-11
130 mm - 5"	tk 18110-13
145 mm - 5¾"	tk 18110-14
160 mm - 6¼"	tk 18110-16
180 mm - 7"	tk 18110-18
200 mm - 8"	tk 18110-20



115 mm - 4½"	tk 18112-11
130 mm - 5"	tk 18112-13
145 mm - 5¾"	tk 18112-14
160 mm - 6¼"	tk 18112-16
180 mm - 7"	tk 18112-18
200 mm - 8"	tk 18112-20



DOYEN
140 mm - 5½"
tk 18115-14

1:2



NÉLATON
160 mm - 6½"
tk 18117-16

1:2

Watteträger
Cotton applicators

Porte-cotons
Porta-algodones
Portacotoni

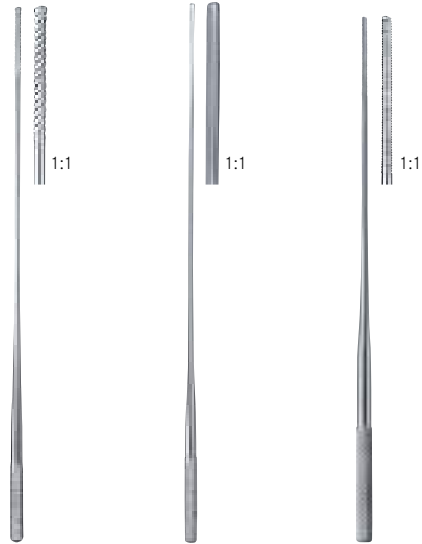

FARRELL-LATHBURY

120 mm - 4 ³ / ₄ "	0.9 mm Ø	tk 19009-12	tk 19109-12	tk 19209-12
140 mm - 5 ¹ / ₂ "	0.9 mm Ø	tk 19009-14	tk 19109-14	tk 19209-14
165 mm - 6 ¹ / ₄ "	1.1 mm Ø	tk 19009-16	tk 19109-16	tk 19209-16
180 mm - 7"	1.2 mm Ø	tk 19009-18	tk 19109-18	tk 19209-18
230 mm - 9"	1.3 mm Ø	tk 19009-23	tk 19109-23	tk 19209-23

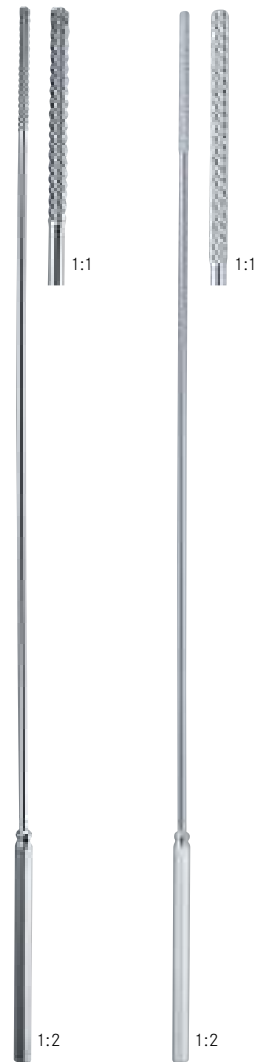

MOD. MARTIN

	1.2 mm Ø	1.5 mm Ø	1.5 mm Ø
120 mm - 4 ³ / ₄ "	tk 19312-12	tk 19315-12	tk 19415-12
140 mm - 5 ¹ / ₂ "	tk 19312-14	tk 19315-14	tk 19415-14
160 mm - 6 ¹ / ₄ "	tk 19312-16	tk 19315-16	tk 19415-16
180 mm - 7"	tk 19312-18	tk 19315-18	tk 19415-18

	2.5 mm Ø	2.5 mm Ø
280 mm - 11"	tk 19460-28	tk 19470-28

Watteträger
Cotton applicators

Porte-cotons
Porta-algodones
Portacotoni



**JOBSON-
HORNE**

180 mm - 7"

tk 19216-18

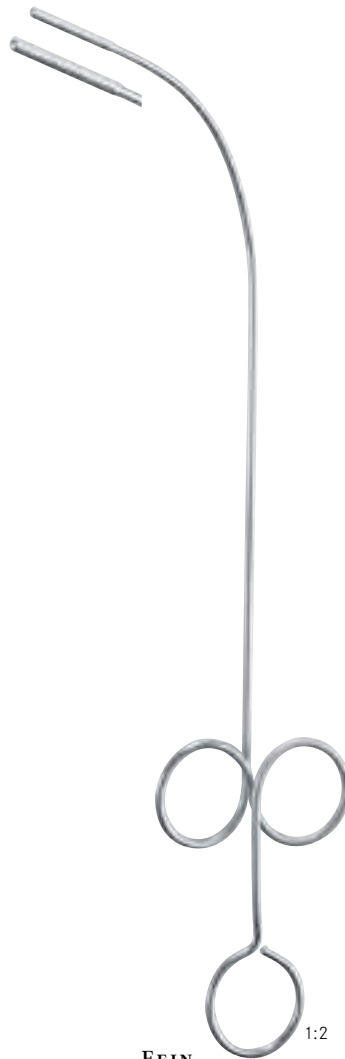

FEIN

280 mm - 11"

tk 19501-28



PELTESON

230 mm - 9"

tk 19503-23



Skalpelle, Messer
Scalpels, Knives

Bistouris, Couteaux
Bisturías, Cuchillos
Bisturi, Coltelli



Operations-Skalpelle
Operating knives

Bistouris pour opérations
Bisturías para operaciones
Bisturi per operazioni



1:1



1:1

1:1

DIEFFENBACH

	Fig. 1	Fig. 2
160 mm – 6¼"	tk 7005-01	tk 7005-02

Operations-Skalpelle
Operating knives

Bistouris pour opérations
Bisturías para operaciones
Bisturi per operazioni

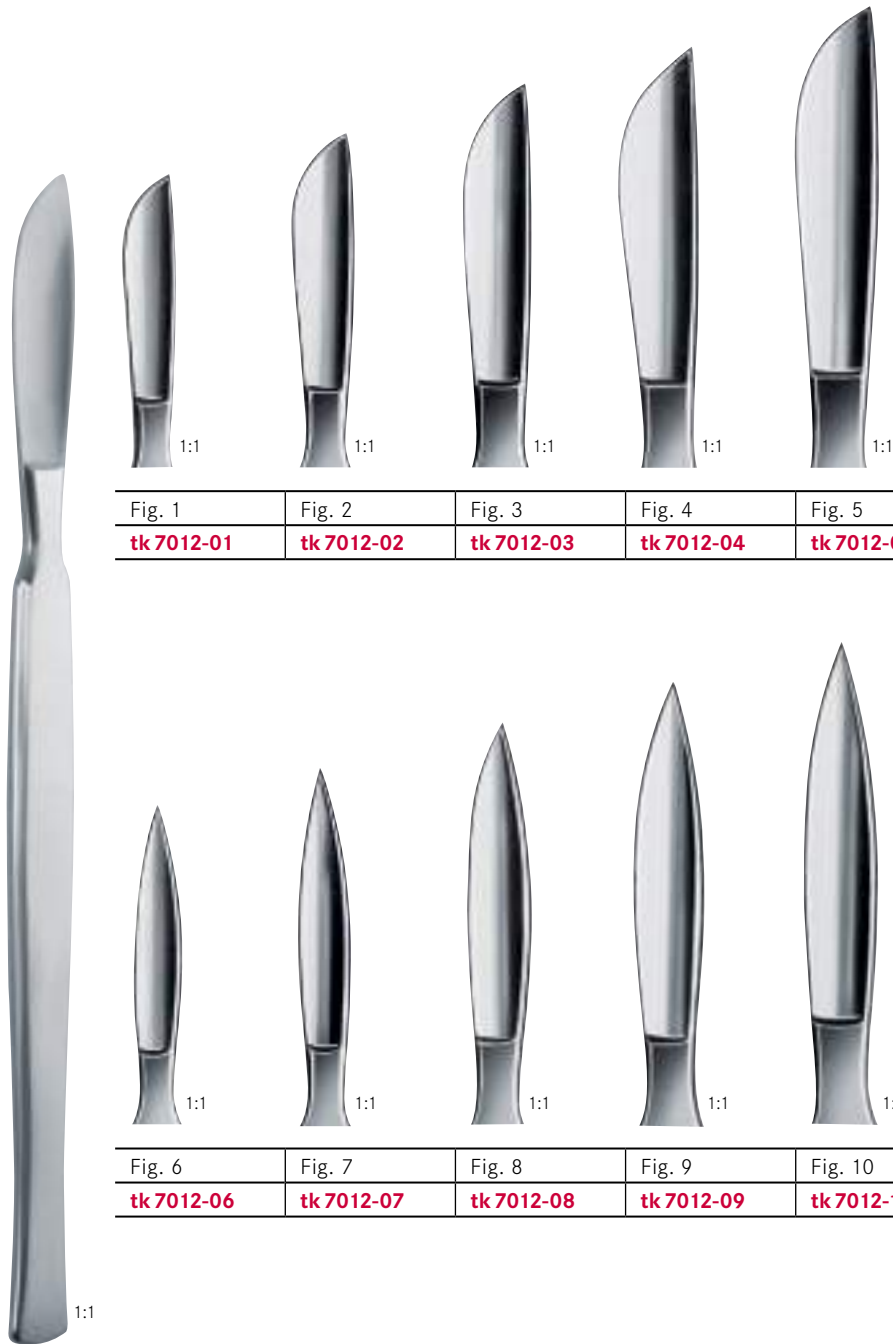

Fig. 1	Fig. 2	Fig. 3	Fig. 4	Fig. 5
tk 7012-01	tk 7012-02	tk 7012-03	tk 7012-04	tk 7012-05

Fig. 6	Fig. 7	Fig. 8	Fig. 9	Fig. 10
tk 7012-06	tk 7012-07	tk 7012-08	tk 7012-09	tk 7012-10

Skalpellgriffe
Scalpel handles

Manches pour bistouri
Mangos de bisturí
Manici per bisturi



Für Klengen Fig. 18 – 25
For blades Fig. 18 – 25
Pour lames Fig. 18 – 25
Para hojas Fig. 18 – 25
Per lame Fig. 18 – 25

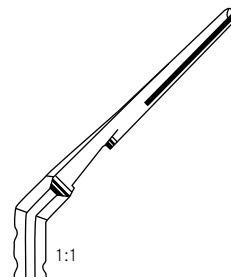

Fig. 4 L

tk 7102-04

abgewinkelt
angled on flat
coudé sur le plat
angulado
angolato



STANDARD

Fig. 4	Fig. 4 L
tk 7100-04	tk 7101-04



COLLIN

Fig. 8

tk 7105-08

hohl
hollow
creux
hueco
cavo

Skalpellgriffe
Scalpel handles

Manches pour bistouri
Mangos de bisturí
Manici per bisturi

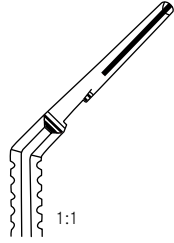

Fig. 3 L

tk 7112-03

abgewinkelt
angled on flat
coudé sur le plat
angulado
angolato



Fig. 3	Fig. 3 L
tk 7110-03	tk 7111-03



Fig. 7K	Fig. 7
tk 7110-71	tk 7110-07



Für Klagen Fig. 10 – 15
For blades Fig. 10 – 15
Pour lames Fig. 10 – 15
Para hojas Fig. 10 – 15
Per lame Fig. 10 – 15



Fig. 3 grad.
tk 7113-05

graduirt
graduated
gradué
graduado
graduato

Fig. 3 R
tk 7115-03

Fig. 3 RG
tk 7116-03

Skalpellklingen
Scalpel blades

Lames de bistouris
Hojas de bisturí
Lame per bisturi



Packung mit 100 Stück
Package of 100 pieces
Paquet de 100 pièces
Paquetes de 100 piezas
Confezione da 100 pezzi



Die abgebildeten Klingen sind steril
The blades on this page are sterile
Les lames de cette page sont stériles
Las hojas de esta página son estériles
Le lame illustrate sono sterili

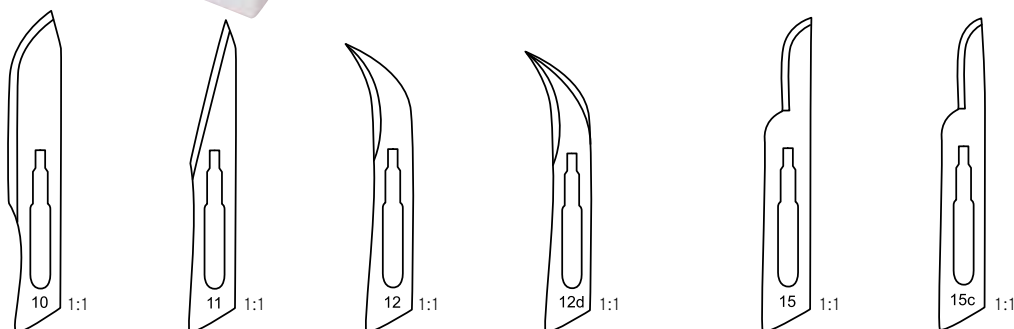

Fig. 10	Fig. 11	Fig. 12	Fig. 12d	Fig. 15	Fig. 15c
tk 7210-10T	tk 7210-11T	tk 7210-12T	tk 7210-12DT	tk 7210-15T	tk 7210-15CT

doppelschneidend
double cutting edge
double tranchante
corta doble
a doppio taglio

passend für Griffe: tk 7110-03, tk 7111-03, tk 7110-07, tk 7110-71, tk 7112-03, tk 7113-03, tk 7115-03, tk 7116-03
for handles: tk 7110-03, tk 7111-03, tk 7110-07, tk 7110-71, tk 7112-03, tk 7113-03, tk 7115-03, tk 7116-03
pour manches: tk 7110-03, tk 7111-03, tk 7110-07, tk 7110-71, tk 7112-03, tk 7113-03, tk 7115-03, tk 7116-03
para mangos: tk 7110-03, tk 7111-03, tk 7110-07, tk 7110-71, tk 7112-03, tk 7113-03, tk 7115-03, tk 7116-03
per manici: tk 7110-03, tk 7111-03, tk 7110-07, tk 7110-71, tk 7112-03, tk 7113-03, tk 7115-03, tk 7116-03

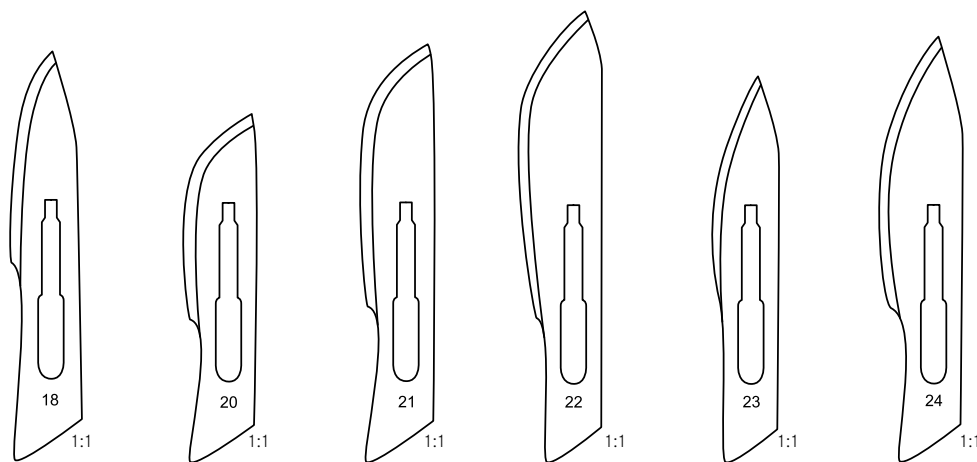

Fig. 18	Fig. 20	Fig. 21	Fig. 22	Fig. 23	Fig. 24
tk 7210-18T	tk 7210-20T	tk 7210-21T	tk 7210-22T	tk 7210-23T	tk 7210-24T

passend für Griffe: tk 7100-04, tk 7101-04, tk 7102-04, tk 7105-08
for handles: tk 7100-04, tk 7101-04, tk 7102-04, tk 7105-08
pour manches: tk 7100-04, tk 7101-04, tk 7102-04, tk 7105-08
para mangos: tk 7100-04, tk 7101-04, tk 7102-04, tk 7105-08
per manici: tk 7100-04, tk 7101-04, tk 7102-04, tk 7105-08

Mikro-Klingenhalter – Mikro-Klingen
Micro-blade holder – Micro-blades

Porte micro-lames – Micro-lames
Porta para micro-hojas – Micro-hojas
 Porta micro-lame – Micro-lame

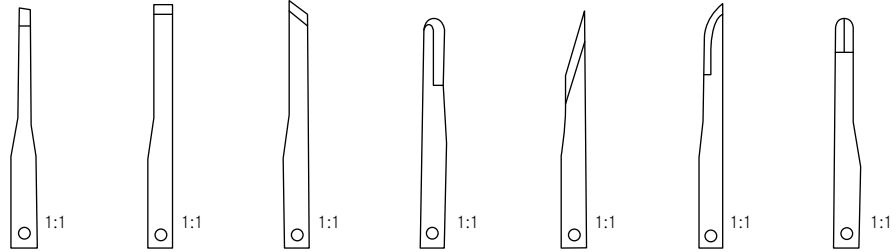

Fig. 61	Fig. 62	Fig. 62s	Fig. 64	Fig. 65	Fig. 67	Fig. 69
tk 7121-61	tk 7121-62	tk 7121-62s	tk 7121-64	tk 7121-65	tk 7121-67	tk 7121-69

Mikro-Klingen – Packung mit 10 Stück
Micro-blades – package of 10 pieces

Micro-lames – paquet de 10 pièces
Micro-hojas – paquete de 10 piezas
 Micro-lame – confezione da 10 pezzi

135 mm – 5 1/4"	130 mm – 5"
tk 7120-13	tk 7117-13

Titan	Rostfreier Stahl
<i>Titanium</i>	<i>stainless steel</i>
Titan	inoxydable acier
<i>Titaneo</i>	<i>inoxidable acero</i>
Titanio	inossidabile acciaio



100 mm – 4"	130 mm – 5"	150 mm – 6"
tk 7125-10	tk 7125-13	tk 7125-15



Die abgebildeten Klingen sind steril.
The blades on this page are sterile.

Les lames de cette page sont stériles.
Las hojas de esta página son estériles.
 Le lame illustrate sono sterili.

Rasierklingenhalter und -brecher
Razor blade holders and breakers

Porte lames et brise lames de rasoir
 Pinzas para sujetar y romper hojas de afeitar
 Rompi-lame di rasoio



1:1



CASTROVIEJO

130 mm – 5" **tk 7215-13**



1:1

TROUTMAN-CHRIS

90 mm – 3½"

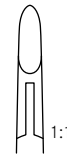

1:1

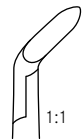

1:1

tk 7220-09

tk 7225-09



1:1

tk 7230-10

Packung mit 10 Stück

Package of 10 pieces

Paquet de 10 pièces

Paquete de 10 piezas

Confezione da 10 pezzi

Rasierklingen, brechbar, rostfrei
Razor blades, breakable, stainless

Lames de rasoir, réfrangibles, inoxydable

Hojas de afeitar, rompible, inoxidable

Lame di rasoio, rompibili, inossidabile



Die abgebildeten Klingen werden nicht steril ausgeliefert.

The blades on this page are not sterile.

Les lames de cette page ne sont pas stériles.

Las hojas de esta página no son estériles.

Le lame illustrate non sono sterili.

Seziermesser
Autopsy knives

Couteaux à dissection
Cuchillos para autopsía
Coltelli per autopsia



VIRCHOW

	x = 120 mm - 4"	x = 80 mm - 3 1/2"
255 mm - 10"	tk 7033-10	tk 7043-08

Seziermesser mit Holzheft

Autopsy knives with wooden handle

Couteaux à autopsie avec manche en bois

Cuchillos para autopsia con mango de madera

Coltelli per autopsia con manico di legno



WALB

260 mm - 10 1/4"	x = 110 mm - 4 1/4"	tk 7046-11
290 mm - 11 1/2"	x = 140 mm - 5 1/2"	tk 7046-14
310 mm - 12 1/4"	x = 170 mm - 6 3/4"	tk 7046-17

Organmesser mit Holzheft

Post mortem knives with wooden handle

Couteaux à organes avec manche en bois

Cuchillos para organos, con mango de madera

Coltelli per organi, con manico di legno



VIRCHOW

260 mm - 10 1/4"	x = 160 mm - 6 1/4"	tk 7048-16
335 mm - 13 1/4"	x = 200 mm - 8"	tk 7048-20
380 mm - 15"	x = 240 mm - 9 1/2"	tk 7048-24

Hirnmesser mit Metallheft

Brain knives with metal handle

Couteaux pour le cerveau, avec manche en métal

Cuchillos para el cerebro, con mango metálico

Coltelli per cervello, con manico di metallo

Amputationsmesser – Resektionsmesser
Amputation knives – Resection knives

Couteaux à amputation – Couteaux à résection
Cuchillos para amputación – Cuchillos para resección
Coltelli per amputazione – Coltelli per resezione



COLLIN

x = 130 mm	tk 7500-13
x = 160 mm	tk 7500-16
x = 190 mm	tk 7500-19
x = 220 mm	tk 7500-22

doppelschneidend
double cutting edge
double tranchant
corta doble
a doppio taglio

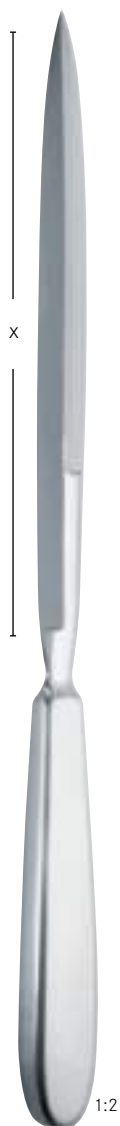

CATLIN

	x = 160 mm
290 mm – 11½"	tk 7505-16

doppelschneidend
double cutting edge
double tranchant
corta doble
a doppio taglio



LANGENBECK

x = 55 mm	x = 55 mm	x = 120 mm
tk 7528-05	tk 7529-05	tk 7550-12



Haarschneidemaschine
Hair clipper

Tondeuse électrique
Máquina de cortar el pelo
Rasoi elettrici



1:2

230V / 50 - 60Hz

tk 7810-00	tk 7810-01	tk 7810-02	tk 7810-03
komplett <i>complete</i>	Schneideaufsatz, Normalzahn <i>Normal cutter</i>	Ladeständer <i>Charger</i>	Steckertrafo EURO mit 3 m Kabel <i>Transformer EURO with 3 m cable</i>
complet <i>completa</i>	Couteau standard <i>Cuchillo normal</i>	Chargeur <i>Cargador</i>	Transformateur EURO avec 3 m cable <i>Transformador EURO con 3 m cable</i>
completa	Testa di taglio dentatura standard	Caricatore	Trasformatore EURO con cavo di 3 m

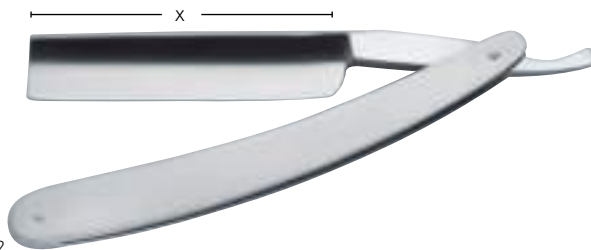

1:2

x = 80 mm

tk 7805-00

Rasiermesser
Razor knife

Rasoir
Navaja de afeitar
Rasoio a mano libera

Dermatome – Transplantationsmesser
 Dermatomes – Transplantation knives

Dermatomes – Bistouries pour transplantation
 Dermatmos – Cuchillos para transplantaciones
 Dermatomi – Coltello per trapianto



THIERSCH

200 mm – 8"

tk 7890-20



SCHINK

300 mm – 12"

tk 7900-00

Komplett mit 1 Klinge und 2 Spannhaltern

Complete with 1 blade and 2 plates

Complet avec 1 lame et 2 plaques

Completo con 1 hoja y 2 placas

Completo con 1 lama e 2 placche



1:2

tk 7901-00

Klinge
 Spare blade

Lame de rechange

Hoja de cambio

Lama di ricambio



1:2

tk 7902-00

Spannplatte
 Skin fixing plate

Plaque pour tendre la peau

Placa para extender la piel

Placca per stendere la pelle



Die abgebildeten Klagen werden nicht steril ausgeliefert.
 The blades on this page are not sterile.

Les lames de cette page ne sont pas stériles.

Las hojas de esta página no son estériles.

Le lame illustrate non sono sterili.



Elektrische Dermatome auf Anfrage lieferbar.
 Electrical dermatomes upon request.

Dermatomes électriques sur demande.

Dermatmos electricos según demanda.

Dermatomi elettrici possono essere forniti a richiesta.

Dermatome
Dermatomes

Dermatomes
Dermatomos
Dermatomi



tk 7908-00

Ersatzklinge für tk 7905-00, tk 7907-00 – Packung mit 10 Stück
spare blade for tk 7905-00, tk 7907-00 – package of 10 pieces

lame de rechange pour tk 7905-00, tk 7907-00 – paquet de 10 pièces
hoja de cambio para tk 7905-00, tk 7907-00 – paquete de 10 piezas
lama di ricambio par tk 7905-00, tk 7907-00 – confezione da 10 pezzi

HUMBY

310 mm – 12 1/4"

tk 7905-00

komplett mit 1 Klinge
complete with 1 blade

complet avec 1 lame
completo con 1 hoja
completo con 1 lama



WATSON

300 mm – 12"

tk 7907-00

komplett mit 1 Klinge, Stange starr
complete with 1 blade, fixed bar

complet avec 1 lame, tige fix
completo con 1 hoja, barra fijada
completo con 1 lama, barra fissa



SILVER

190 mm – 7 1/2"

tk 7904-00



tk 7230-10

Ersatzklinge für tk 7904-00 –
Packung mit 10 Stück
spare blade for tk 7904-00 –
package of 10 pieces

lame de rechange pour tk 7904-00 –
paquet de 10 pièces
hoja de cambio para tk 7904-00 –
paquete de 10 piezas
lama di ricambio par tk 7904-00 –
confezione da 10 pezzi



Die abgebildeten Klingen werden nicht steril ausgeliefert.
The blades on this page are not sterile.

Les lames de cette page ne sont pas stériles.
Las hojas de esta página no son estériles.
Le lame illustrate non sono sterili.



Elektrische Dermatome auf Anfrage lieferbar.
Electrical dermatomes upon request.

Dermatomes électriques sur demande.
Dermatomos electricos según demanda.
Dermatomi elettrici possono essere forniti a richiesta.



Scheren | Ciseaux
Scissors | Tijeras
Forbici



Chirurgische Scheren | Ciseaux à chirurgie
Operating scissors | Tijeras para cirugía
 Forbici per chirurgia



STANDARD

	Fig. 1	Fig. 2	Fig. 3
105 mm - 4 1/4 "	tk 8023-10	tk 8024-10	tk 8025-10
115 mm - 4 1/2 "	tk 8023-11	tk 8024-11	tk 8025-11
130 mm - 5 "	tk 8023-13	tk 8024-13	tk 8025-13
145 mm - 5 3/4 "	tk 8023-14	tk 8024-14	tk 8025-14
155 mm - 6 "	tk 8023-15	tk 8024-15	tk 8025-15
165 mm - 6 1/2 "	tk 8023-16	tk 8024-16	tk 8025-16
175 mm - 7 "	tk 8023-17	tk 8024-17	tk 8025-17
185 mm - 7 1/4 "	tk 8023-18	tk 8024-18	tk 8025-18
200 mm - 8 "	tk 8023-20	tk 8024-20	tk 8025-20



STANDARD

	Fig. 1	Fig. 2	Fig. 3
115 mm - 4 1/2 "	tk 8033-11	tk 8034-11	tk 8035-11
130 mm - 5 "	tk 8033-13	tk 8034-13	tk 8035-13
145 mm - 5 3/4 "	tk 8033-14	tk 8034-14	tk 8035-14
155 mm - 6 "	tk 8033-15	tk 8034-15	tk 8035-15
165 mm - 6 1/2 "	tk 8033-16	tk 8034-16	tk 8035-16
175 mm - 7 "	tk 8033-17	tk 8034-17	tk 8035-17
185 mm - 7 1/4 "	tk 8033-18	tk 8034-18	tk 8035-18
200 mm - 8 "	tk 8033-20	tk 8034-20	tk 8035-20

Chirurgische Scheren
Operating scissors

Ciseaux à chirurgie
Tijeras para cirugía
Forbici per chirurgia



GRAZIL

	Fig. 1	Fig. 2	Fig. 3
130 mm - 5"	tk 8043-13	tk 8044-13	tk 8045-13
145 mm - 5¾"	tk 8043-14	tk 8044-14	tk 8045-14



GRAZIL

	Fig. 1	Fig. 2	Fig. 3
130 mm - 5"	tk 8053-13	tk 8054-13	tk 8055-13
145 mm - 5¾"	tk 8053-14	tk 8054-14	tk 8055-14

Chirurgische Scheren
Operating scissors

Ciseaux à chirurgie
Tijeras para cirugía
Forbici per chirurgia



DEAVER

145 mm - 5 3/4"



1:2

gerade
straight
droits
recta
rette

tk 8062-14



1:2

gebogen
curved
courbes
curva
curve

tk 8063-14



1:2

gerade, gezahnt
straight, saw edge
droits, dentelés
recta, dentada
rette, dentate

tk 8072-14



1:2

gebogen, gezahnt
curved, saw edge
courbes, dentelés
curva, dentada
curve, dentate

tk 8073-14



LANGE

145 mm - 5 3/4"



1:2

gerade
straight
droits
recta
rette

tk 8082-14



1:2

gebogen
curved
courbes
curva
curve

tk 8083-14



1:2

gerade, gezahnt
straight, saw edge
droits, dentelés
recta, dentada
rette, dentate

tk 8092-14



1:2

gebogen, gezahnt
curved, saw edge
courbes, dentelés
curva, dentada
curve, dentate

tk 8093-14

Chirurgische Scheren
Operating scissors

Ciseaux à chirurgie
Tijeras para cirugía
Forbici per chirurgia



MIXTER

155 mm - 6"	tk 8102-15	tk 8112-15	tk 8103-15	tk 8113-15
gerade <i>straight</i>	gerade, gezahnt <i>straight, saw edge</i>	gerade, gezahnt <i>straight, saw edge</i>	gebogen <i>curved</i>	gebogen, gezahnt <i>curved, saw edge</i>
droits <i>recta</i>	droits, dentelés <i>recta, dentada</i>	droits, dentelés <i>recta, dentada</i>	courbes <i>curva</i>	courbes, dentelés <i>curva, dentada</i>
rette	rette, dentate	rette, dentate	curve	curve, dentate



1:2



1:2



LEXER

160 mm - 6 1/4"	tk 8122-16	tk 8123-16
210 mm - 8 1/4" <th>tk 8122-21</th> <th>tk 8123-21</th>	tk 8122-21	tk 8123-21



Chirurgische Scheren
Operating scissors

Ciseaux à chirurgie
Tijeras para cirugía
Forbici per chirurgia



RICHTER

140 mm - 5½"

tk 8142-14

1:2



FERGUSSON

140 mm - 5½"

tk 8152-14

160 mm - 6¼"

tk 8152-16

180 mm - 7"

tk 8152-18



130 mm - 5"

tk 8132-13

145 mm - 5¾"

tk 8132-14

Chirurgische Scheren – Präparierscheren
Operating scissors – Dissecting scissors

Ciseaux à chirurgie – Ciseaux à dissection
Tijeras para cirugía – Tijeras de disección
 Forbici per chirurgia – Forbici per dissezione



MAYO

145 mm – 5¾"	tk 8272-14	tk 8273-14
150 mm – 6"	tk 8272-15	tk 8273-15
170 mm – 6¾"	tk 8272-17	tk 8273-17
230 mm – 9"	tk 8272-23	tk 8273-23



MAYO-STILLE

150 mm – 6"	tk 8282-15	tk 8283-15
170 mm – 6¾"	tk 8282-17	tk 8283-17
195 mm – 7¾"	tk 8282-19	tk 8283-19
210 mm – 8¾"	tk 8282-21	tk 8283-21

Chirurgische Scheren – Präparierscheren
Operating scissors – Dissecting scissors

Ciseaux à chirurgie – Ciseaux à dissection
Tijeras para cirugía – Tijeras de disección
 Forbici per chirurgia – Forbici per dissezione



MAYO-HARRINGTON

220 mm – 8¾"



1:2



1:2

tk 8275-22

tk 8276-22



MAYO-NOBLE

170 mm – 6¾"



1:2



1:2

tk 8292-17

tk 8293-17

Chirurgische Scheren – Präparierscheren
Operating scissors – Dissecting scissors

Ciseaux à chirurgie – Ciseaux à dissection
Tijeras para cirugía – Tijeras de disección
 Forbici per chirurgia – Forbici per dissezione



WERTHEIM

145 mm – 5¾"	tk 8295-14
225 mm – 8¾"	tk 8295-22



METZENBAUM

150 mm – 6"	tk 8343-15	tk 8353-15
-------------	-------------------	-------------------



Chirurgische Scheren – Präparierscheren
 Operating scissors – Dissecting scissors

Ciseaux à chirurgie – Ciseaux à dissection
 Tijeras para cirugía – Tijeras de disección
 Forbici per chirurgia – Forbici per dissezione



1:2

1:2

METZENBAUM

	Fig. 1	Fig. 2	Fig. 3
115 mm - 4½"	tk 8323-11		
145 mm - 5¾"	tk 8323-14	tk 8324-14	tk 8325-14



1:2

1:2

METZENBAUM

	Fig. 1	Fig. 2	Fig. 3
115 mm - 4½"	tk 8333-11		
145 mm - 5¾"	tk 8333-14	tk 8334-14	tk 8335-14

Chirurgische Scheren – Präparierscheren
Operating scissors – Dissecting scissors

Ciseaux à chirurgie – Ciseaux à dissection
Tijeras para cirugía – Tijeras de disección
 Forbici per chirurgia – Forbici per dissezione



**METZENBAUM-
NELSON**

	Fig. 1	Fig. 2	Fig. 3
180 mm - 7"	tk 8343-18	tk 8344-18	tk 8345-18
200 mm - 8"	tk 8343-20	tk 8344-20	tk 8345-20
230 mm - 9"	tk 8343-23	tk 8344-23	tk 8345-23
250 mm - 9¾"	tk 8343-25	tk 8344-25	tk 8345-25
280 mm - 11"	tk 8343-28	tk 8344-28	tk 8345-28
300 mm - 12"	tk 8343-30	tk 8344-30	tk 8345-30



**METZENBAUM-
NELSON**

	Fig. 1	Fig. 2	Fig. 3
180 mm - 7"	tk 8353-18	tk 8354-18	tk 8356-18
200 mm - 8"	tk 8353-20	tk 8354-20	tk 8356-20
230 mm - 9"	tk 8353-23	tk 8354-23	tk 8356-23
250 mm - 9¾"	tk 8353-25	tk 8354-25	tk 8356-25
280 mm - 11"	tk 8353-28	tk 8354-28	tk 8356-28
300 mm - 12"	tk 8353-30	tk 8354-30	tk 8356-30

Chirurgische Scheren – Präparierscheren
Operating scissors – Dissecting scissors

Ciseaux à chirurgie – Ciseaux à dissection
Tijeras para cirugía – Tijeras de disección
 Forbici per chirurgia – Forbici per dissezione



METZENBAUM-FINO



1:2



1:2



1:2



1:2

	Fig. 1	Fig. 3	Fig. 1	Fig. 3
145 mm – 5¾"	tk 8372-14	tk 8374-14	tk 8373-14	tk 8375-14



METZENBAUM-FINO



180 mm – 7"	tk 8380-18	tk 8381-18	tk 8385-18
200 mm – 7¾"	tk 8380-20	tk 8381-20	tk 8385-20
230 mm – 9"	tk 8380-23	tk 8381-23	tk 8385-23

S-förmig gebogen
S-curved
 courbes en S
curva en S
 curve a forma di S

Präparierscheren
Dissecting scissors

Ciseaux à dissection
Tijeras de disección
Forbici per dissezione



FOMON

135 mm - 5 1/4"

tk 8392-14

1:2



THOREK

190 mm - 7 1/2"

tk 8394-19

1:2

Gynäkologische Scheren
Gynaecological scissors

Ciseaux à gynécologie
Tijeras para ginecología
Forbici per ginecologia



SIMS

	Fig. 1	Fig. 2	Fig. 1	Fig. 2
200 mm - 8"	tk 8423-20	tk 8424-20	tk 8433-20	tk 8434-20
230 mm - 9"	tk 8423-23	tk 8424-23	tk 8433-23	tk 8434-23

Gynäkologische Scheren
Gynaecological scissors

Ciseaux à gynécologie
Tijeras para ginecología
Forbici per ginecologia



1:2

DUBOIS

270 mm - 10³/₄"

tk 8442-27

tk 8443-27



1:2

1:2



1:2

DOYEN

175 mm - 7"

tk 8452-17

tk 8453-17



1:2

1:2



1:2

SIEBOLD

240 mm - 9¹/₂"

tk 8477-24

S-förmig gebogen

S-curved

courbes en S

curva en S

curve a forma di S

Feine chirurgische Scheren
Fine operating scissors

Ciseaux fins à chirurgie
Tijeras finas para cirugía
Forbici fine per chirurgia

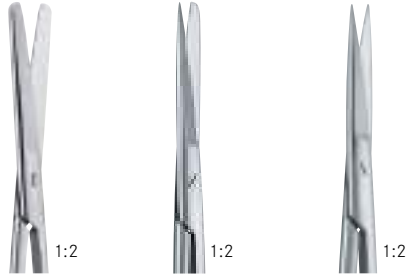

	Fig. 1	Fig. 2	Fig. 3
120 mm - 4 $\frac{3}{4}$ "	tk 8523-12	tk 8524-12	tk 8525-12

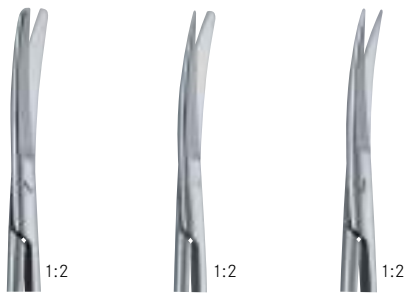
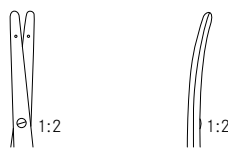

	Fig. 1	Fig. 2	Fig. 3
120 mm - 4 $\frac{3}{4}$ "	tk 8533-12	tk 8534-12	tk 8535-12



KNAPP

105 mm - 4 $\frac{1}{4}$ "	tk 8688-10	tk 8689-10
----------------------------	-------------------	-------------------

stumpf
blunt
mousses
roma
smusse

Feine Scheren
Fine scissors

Ciseaux fins
Tijeras finas
Forbici fini



WAGNER

120 mm - 4³/₄ "



1:2

tk 8542-12
gerade
straight
droits
recta
rette

tk 8552-12

gerade, gezahnt
straight, saw edge
droits, dentelés
recta, dentada
rette, dentate



1:2

tk 8543-12

gebogen
curved
courbes
curva
curve

tk 8553-12

gebogen, gezahnt
curved, saw edge
courbes, dentelés
curva, dentada
curve, dentate



BROPHY
(SULLIVAN)

145 mm - 5³/₄ "



1:2

tk 8572-14



1:2

tk 8573-14



LITTLER

115 mm - 4¹/₂ "

145 mm - 5³/₄ "



1:2

tk 8571-11

tk 8571-14

Feine Scheren
Fine scissors

Ciseaux fins
Tijeras finas
Forbici fini



LOCKLIN

165 mm - 6 1/2 "

tk 8582-16

tk 8587-16

gezahnt
saw edge,
dentelées
dentada
dentate

QUINBY

125 mm - 5 "

tk 8592-12



REYNOLDS

160 mm - 6 1/4 "

tk 8602-16

tk 8603-16

180 mm - 7 "

tk 8602-18

tk 8603-18



NEUMANN

120 mm - 4 3/4 "

tk 8597-12

S-förmig gebogen
S-curved

courbes en S
curva en S
curve a forma di S

Feine Scheren
Fine scissors

Ciseaux fins
Tijeras finas
Forbici fini



105 mm - 4 1/4"	tk 8622-10	tk 8623-10
-----------------	-------------------	-------------------



110 mm - 4 1/4"	tk 8632-11	tk 8633-11
-----------------	-------------------	-------------------

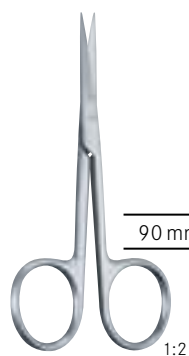

90 mm - 3 1/2"	tk 8642-09	tk 8643-09
----------------	-------------------	-------------------

Feine Scheren
Fine scissors

Ciseaux fins
Tijeras finas
Forbici fini



90 mm - 3½"	tk 8652-09	tk 8653-09
100 mm - 4"	tk 8652-10	tk 8653-10
115 mm - 4½"	tk 8652-11	tk 8653-11

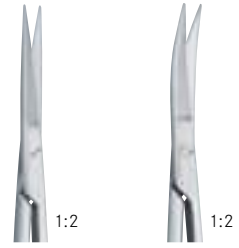

SANVENERO

145 mm - 5¾"	tk 8662-14	tk 8663-14
--------------	-------------------	-------------------



LEXER-BABY

100 mm - 4"	tk 8672-10	tk 8682-10	tk 8673-10	tk 8683-10
-------------	-------------------	-------------------	-------------------	-------------------

gerade
straight
droits
recta
rette

gerade, gezahnt
straight, saw edge
droits, dentelés
recta, dentada
rette, dentate

gebogen
curved
courbes
curva
curve

gebogen, gezahnt
curved, saw edge
courbes, dentelés
curva, dentad
curve, dentate

Fistelscheren
Fistula scissors

Ciseaux pour fistules
Tijeras para fistulas
Forbici per fistole



KELLY

160 mm - 6 1/4"	tk 8462-16	tk 8463-16
180 mm - 7"	tk 8462-18	tk 8463-18

Enucleationsscheren
Enucleation scissors

Ciseaux à énucléation
Tijeras para enucleación
Forbici per enucleazione

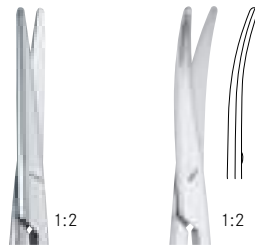

LANDOLDT

125 mm - 5"	tk 8612-12	tk 8614-12
-------------	-------------------	-------------------



CHADWICK

110 mm - 4 1/4"	tk 9485-11
110 mm - 4 1/4"	tk 9492-11

Scheren für die Plastische Chirurgie
Plastic surgery scissors

Ciseaux pour la chirurgie plastique
Tijeras para cirugía plástica
 Forbici per chirurgia plastica



JOSEPH

140 mm - 5½"



1:2



1:2

tk 8692-14

tk 8693-14



KILNER (RAGNELL)

120 mm - 4¾"

150 mm - 6"

tk 8697-12

tk 8697-15



GORNEY

200 mm - 8"

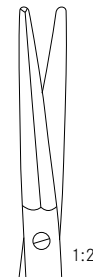

1:2

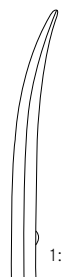

1:2

tk 8700-20

tk 8701-20



Bitte fordern Sie unseren Spezialkatalog für Plastische Chirurgie an.
Please ask for our special catalogue for plastic surgery.

Veuillez demander pour notre catalogue spécial pour la chirurgie plastique.
Por favor preguntan para el catalogo especial para la cirugía plástica.

Per favore domandate per il nostro catalogo speciale per la chirurgia plastica.

Gefäßscheren
Artery scissors

Ciseaux vasculaires
Tijeras vasculares
Forbici vascolari



145 mm - 5¾"
tk 8722-14

- 1 Blatt mit Sondenspitze
- 1 Blade with probe
- 1 Lame avec sonde
- 1 Punta forma sonda
- 1 Lama con sonda



LINCOLN
170 mm - 6¾"



1:2



1:2

tk 8724-17 tk 8725-17



115 mm - 4½"
tk 8727-11



FULTON
170 mm - 6¾"
tk 8730-17



POTTS-SMITH
(DE MARTEL)
195 mm - 7¾"
tk 8732-19

Gefäßscheren
Artery scissors

Ciseaux vasculaires
Tijeras vasculares
Forbici vascolari



FAVALORO
150 mm - 6"
tk 8740-15

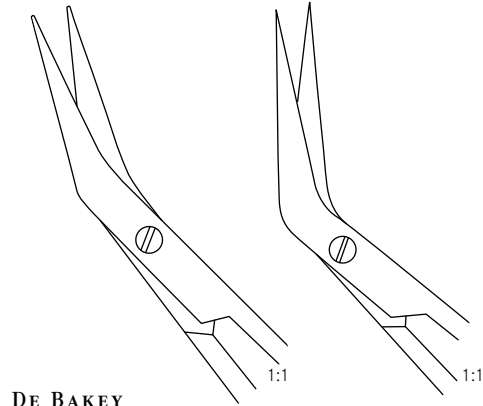

DE BAKEY
155 mm - 6" **tk 8741-15** **tk 8742-15**

Offset-Schere, S-förmig
Offset scissors, s-shaped

Ciseaux offset, courbes en S
Tijera offset, curva en S
Forbici offset, curve a forma di S

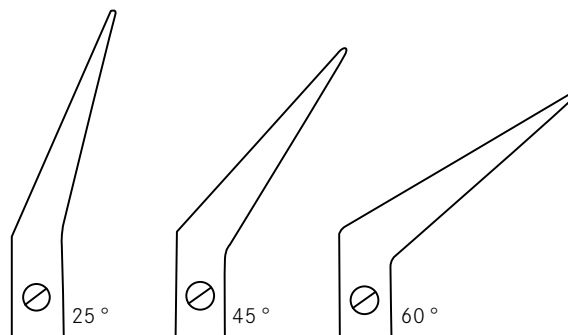

DE BAKEY

160 mm - 6¼"	tk 8745-16	tk 8746-16	tk 8747-16
230 mm - 9"	tk 8745-23	tk 8746-23	tk 8747-23
280 mm - 11"	tk 8745-28	tk 8746-28	tk 8747-28



MILLS
225 mm - 8¾"
tk 8744-22

Gefäßscheren
 Artery scissors

Ciseaux vasculaires
 Tijeras vasculares
 Forbici vascolari



POTTS-DE
 MARTEL

190 mm - 7½"

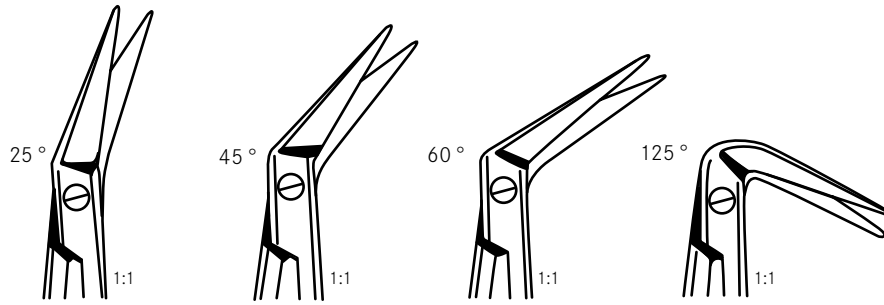

tk 8771-25	tk 8771-45	tk 8771-60	tk 8771-12
-------------------	-------------------	-------------------	-------------------

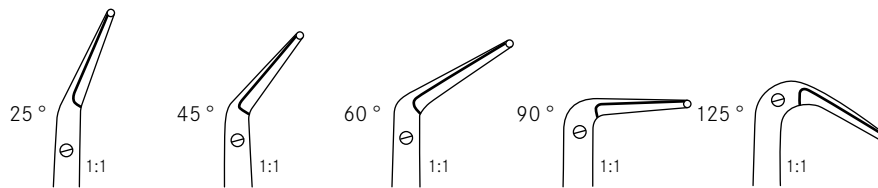

180 mm - 7"	tk 8772-25	tk 8772-45	tk 8772-60	tk 8772-90	tk 8772-12
-------------	-------------------	-------------------	-------------------	-------------------	-------------------

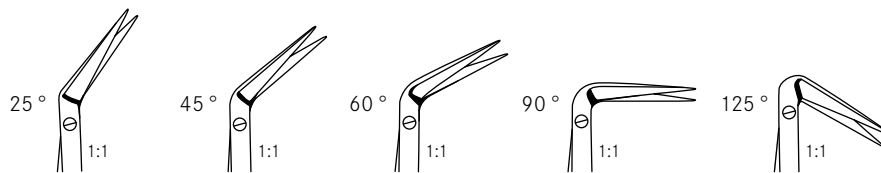

tk 8774-25	tk 8774-45	tk 8774-60	tk 8774-90	tk 8774-12
-------------------	-------------------	-------------------	-------------------	-------------------

Gefäßscheren
Artery scissors

Ciseaux vasculaires
Tijeras vasculares
Forbici vascolari

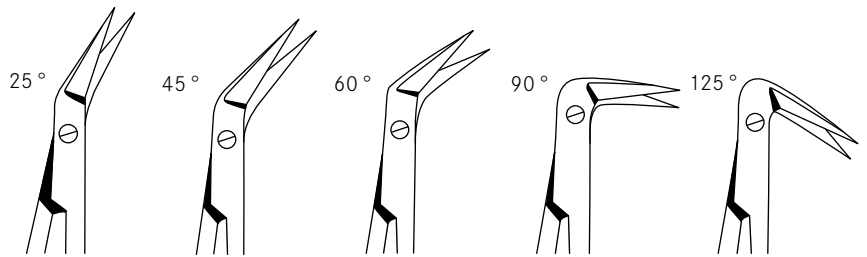

DIETRICH-
HEGEMANN

145 mm - 5¾"	tk 8754-14	tk 8755-14	tk 8756-14	tk 8757-14	tk 8758-14
160 mm - 6¼"	tk 8754-16	tk 8755-16	tk 8756-16	tk 8757-16	tk 8758-16
190 mm - 7½"	tk 8754-19	tk 8755-19	tk 8756-19	tk 8757-19	tk 8758-19

Knorpelscheren
Cartilage scissors

Ciseaux pour cartilages
Tijeras para cartilagos
Forbici per cartilagini



MARTIN-CARTILAGE

190 mm - 7½" **tk 8747-19**

gebogen, gezahnt
curved, saw edge
courbes, dentelés
curva, dentada
curve, dentate



MC INDOE

190 mm - 7½" **tk 8752-19**



POTTS-SMITH

190 mm - 7½" **tk 8753-19**

Tonsillenscheren
Tonsil scissors

Ciseaux pour amygdales
Tijeras para amigdales
Forbici per tonsille



BOETTCHER

180 mm - 7"

tk 8832-18



PRINCE

175 mm - 7"

tk 8837-17



TOENNIS-ADSON

170 mm - 6³/₄"

tk 8847-17

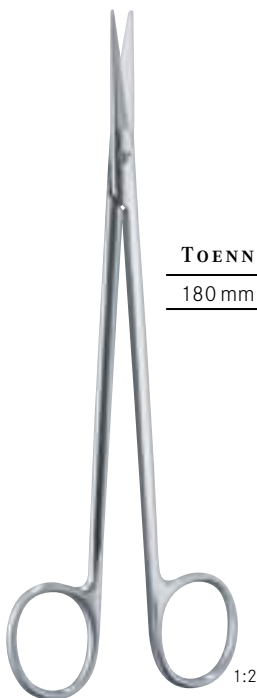

TOENNIS

180 mm - 7"

tk 8842-18

tk 8843-18



1:1



1:1

Tonsillenscheren
Tonsil scissors

Ciseaux pour amygdales
Tijeras para amigdales
Forbici per tonsille



DEAN

170 cm - 6¾"

tk 8852-17

tk 8857-17

gebogen
curved

courbes
curva

curve

gebogen, gezahnt
curved, saw edge

courbes, dentelés
curva, dentada

curve, dentate

1:2



WERTHEIM

190 mm - 7½"

tk 8862-19

1:2



1:1

OLIVECRONA

230 mm - 9"

tk 8849-23

Trigeminusschere
Trigeminal scissors

Ciseaux pour le trigeminus
Tijera para nervio trigémino
Forbici per il nervo trigemino

1:2



GOOD

190 mm - 7½"

tk 8867-19

1:2

Lungenscheren
Lobectomy scissors

Ciseaux à lobectomie
Tijeras para lobectomia
Forbici per lobectomia



CRAFOORD

300 mm - 12"	tk 8882-30
--------------	-------------------

1:3



WILLAUER

250 mm - 9 ³ / ₄ "	tk 8892-25	tk 8893-25
280 mm - 11"	tk 8892-28	tk 8893-28

gerade
straight

droits
recta
rette

gebogen
curved

courbes
curva
curve

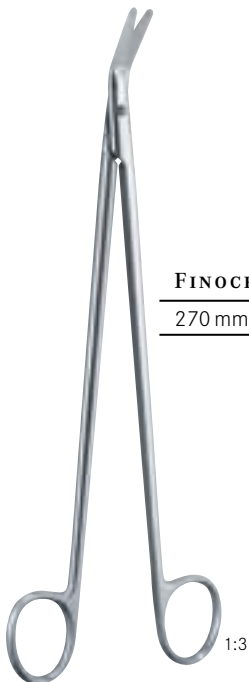

FINOCHIETTO

270 mm - 10 ³ / ₄ "	tk 8912-27
---	-------------------

1:3



RESANO

250 mm - 10"	tk 8939-25
--------------	-------------------

1:3

Thoraxscheren
Thorax scissors

Ciseaux pour le thorax
Tijeras para torax
Forbici per torace



SATINSKY

245 mm - 9 $\frac{3}{4}$ " tk 8762-24



KLINKENBERG-LOTH

230 mm - 9" tk 8767-23



JORGENSEN

220 mm - 8 $\frac{3}{4}$ " tk 8769-22

Darmscheren
Enterotomy scissors

Ciseaux pour l'intestin
Tijeras para intestino
Forbici per enterotomia



	Fig. 1	Fig. 2	Fig. 3
210 mm - 8 1/4"	tk 8922-21	tk 8927-21	tk 8932-21

Nabelschnurscheren
Umbilical scissors

Ciseaux pour le cordon ombilical
Tijeras umbilicales
Forbici ombelicali



BUSCH

130 mm - 5"	tk 9022-13	tk 9027-13
160 mm - 6 $\frac{1}{4}$ "	tk 9022-16	tk 9027-16

gezahnt
saw edge
dentelés
dentada
dentate



SCHUMACHER

160 mm - 6 $\frac{1}{4}$ "	tk 9032-16
----------------------------	-------------------



MOD. USA

105 mm - 4 $\frac{1}{4}$ "	tk 9042-10
----------------------------	-------------------

Episiotomiescheren
Episiotomy scissors

Ciseaux à épisiotomie
Tijeras para episiotomia
Forbici per episiotomia



BRAUN-STADLER

145 mm - 5¾"

tk 9072-14

220 mm - 8¾"

tk 9077-22



1:2

WALDMANN

180 mm - 7"

tk 9107-18

Parametriumscheren
Parametrium scissors

Parametrium ciseaux
Parametrium tijeras
 Forbici per il parametrio

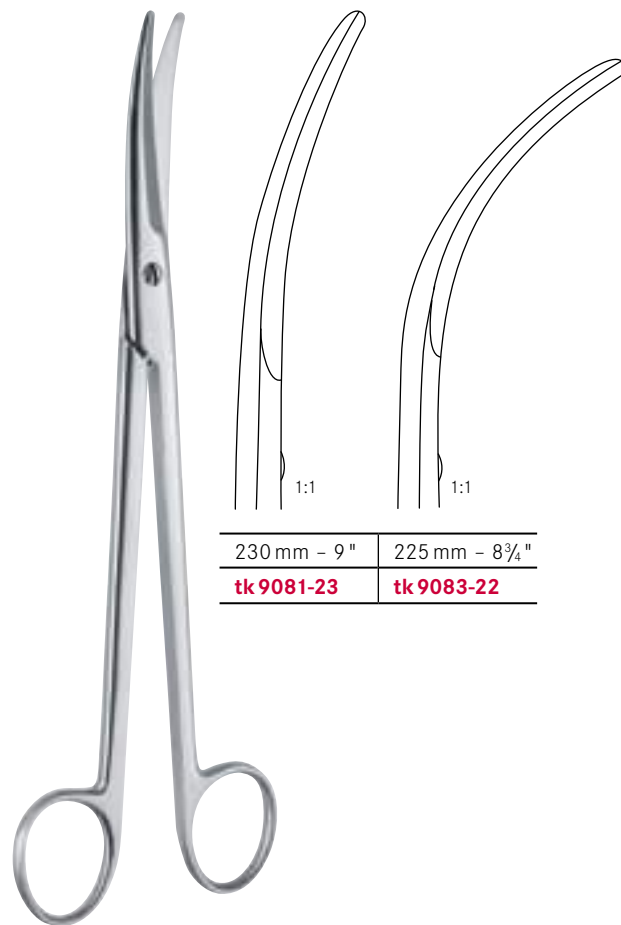

230 mm - 9"	225 mm - 8¾"
tk 9081-23	tk 9083-22

Nasenscheren
Nasal scissors

Ciseaux nasaux
Tijeras nasales
Forbici nasali



SAILER

170 mm - 6³/₄" **tk 9132-17**



HEYMANN

180 mm - 7" **tk 9137-18**



FOMON

130 mm - 5" **tk 9152-13**



COTTLE

160 mm - 6¹/₄" **tk 9157-16**

Mikroscheren | Micro-ciseaux
 Micro scissors | Micro-tijeras
 Micro-forbici



1:1



1:1

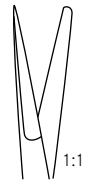

1:1

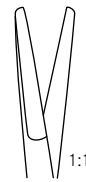

1:1

NOYES

	Fig. 1	Fig. 2	Fig. 3
120 mm - 4 3/4"	tk 9222-01	tk 9222-02	tk 9222-03
gerade straight	spitz - spitz sharp - sharp	spitz - stumpf sharp - blunt	stumpf - stumpf blunt - blunt
droits recta	pointue - pointue aguda - aguda	pointue - mousse roma - aguda	mousse - mousse roma - roma
rette	acuta - acuta	acuta - smussa	smussa - smussa



1:1



1:1

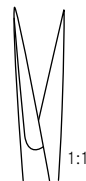

1:1



1:1



1:1

NOYES

	Fig. 1	Fig. 2	Fig. 3
120 mm - 4 3/4"	tk 9223-01	tk 9223-02	tk 9223-03
abgewinkelt angulated	spitz - spitz sharp - sharp	spitz - stumpf sharp - blunt	stumpf - stumpf blunt - blunt
coudé angulado	pointue - pointue aguda - aguda	pointue - mousse roma - aguda	mousse - mousse roma - roma
angolate	acuta - acuta	acuta - smussa	smussa - smussa

Mikroscheren
Micro scissors

Micro-ciseaux
Micro-tijeras
Micro-forbici



120 mm - 4 3/4" **tk 9230-12**

1:1



BARRAQUER

	55 mm - 2 1/4"
x = 7 mm	tk 9252-05
x = 10 mm	tk 9257-05

1:1



1:1

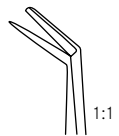

1:1

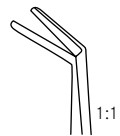

1:1

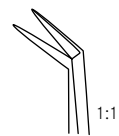

1:1

WECKER

	Fig. 1	Fig. 2	Fig. 3
110 mm - 4 1/4"	tk 9243-11	tk 9244-11	tk 9245-11

spitz - stumpf
sharp - blunt

stumpf - stumpf
blunt - blunt

spitz - spitz
sharp - sharp

pointue - mousse
roma - aguda
acuta - smussa

mousse - mousse
roma - roma
smussa - smussa

pointue - pointue
aguda - aguda
acuta - acuta

Mikroscheren
Micro scissors

Micro-ciseaux
Micro-tijeras
Micro-forbici

! Weitere Mikroscheren auf Seite 598-612.
Additional micro scissors on page 598-612.

Plus de Micro-ciseaux à la page 598-612.

Más Micro tijeras en la página 598-612.

Altri modelli sulla pagina 598-612.



WESTCOTT

115 mm - 4½"



1:1



1:1

tk 9262-11

tk 9263-11



CASTROVIEJO

90 mm - 3½"

tk 9272-09

1:1

Mikroscheren
Micro scissors

Micro-ciseaux
Micro-tijeras
Micro-forbici



1:1



1:1



1:1

VANNAS

80 mm – 3 1/4"

tk 9282-08

tk 9283-08



1:1



1:1



1:1

CASTROVIEJO

100 mm – 4"

tk 9322-10

tk 9332-10

spitz – spitz

sharp – sharp

pointue – pointue

aguda – aguda

acuta – acuta

stumpf – stumpf

blunt – blunt

mousse – mousse

roma – roma

smussa – smussa

Sehnenscheren
Tenotomy scissors

Ciseaux à ténatomie
Tijeras para tenotomía
Forbici per tenotomia

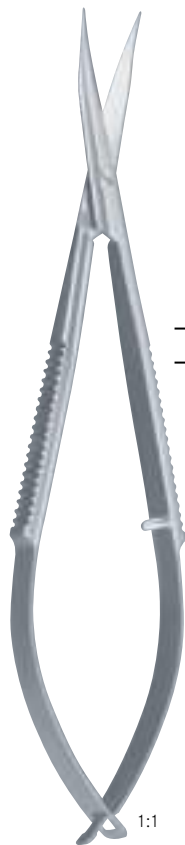

WESTCOTT

110 mm - 4 1/4"

tk 9352-11

tk 9357-11

spitz - spitz
sharp - sharp

pointue - pointue
aguda - aguda
acuta - acuta

stumpf - stumpf
blunt - blunt

mousse - mousse
roma - roma
smussa - smussa

Irisscheren
Iris scissors

Ciseaux à iridectomie
Tijeras para iridectomia
Forbici per iridectomia

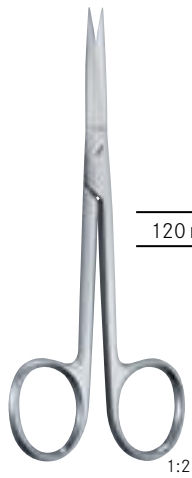

120 mm - 4¾"

tk 9422-12

tk 9423-12



1:2



1:2



115 mm - 4½"

tk 9432-11

tk 9434-11

tk 9436-11

tk 9438-11

gerade
straight
droits
recta
rette

gebogen
curved
courbes
curva
curve

kniegebogen
angular
coudés
acodada
angolata

seitwärts gebogen
laterally curved
courbes laterale
curva lateral
curvata lateralmente



1:2



1:2



1:2



1:2

Sehnenscheren
Tenotomy scissors

Ciseaux à ténatomie
Tijeras para tenotomia
Forbici per tenotomia

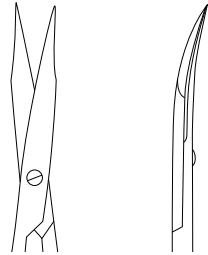

STEVENS

100 mm - 4"	tk 9452-10	tk 9453-10
110 mm - 4 1/4"	tk 9452-11	tk 9453-11

spitz - spitz
sharp - sharp
pointue - pointue
aguda - aguda
acuta - acuta

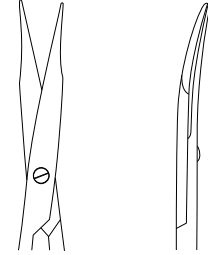
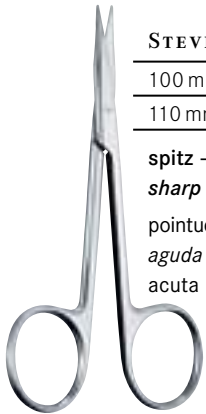

STEVENS

100 mm - 4"	tk 9462-10	tk 9463-10
110 mm - 4 1/4"	tk 9462-11	tk 9463-11

stumpf - stumpf
blunt - blunt
mousse - mousse
roma - roma
smussa - smussa

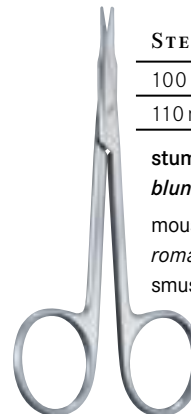

WALTON

100 mm - 4"	tk 9473-10
-------------	-------------------



1:2

GRAEFE

95 mm - 3 3/4"	tk 9477-09
----------------	-------------------



1:2

Strabismusscheren
Strabismus scissors

Ciseaux à strabisme
Tijeras para estrabismo
Forbici per strabismo

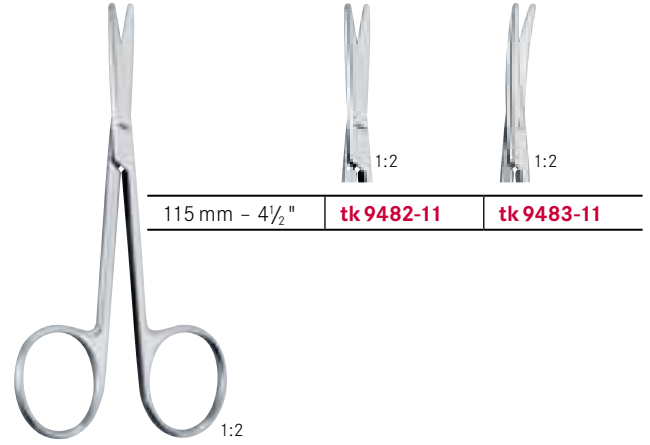
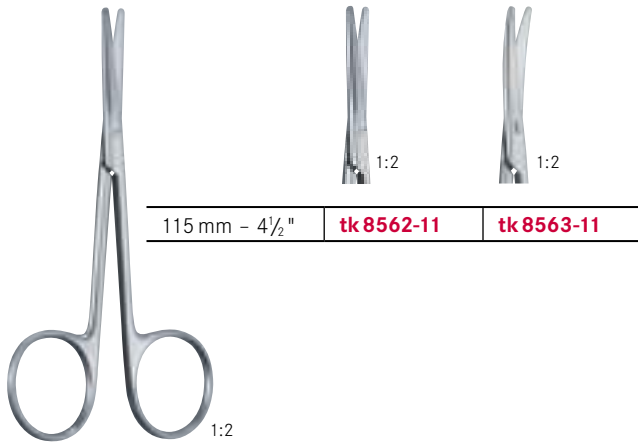

Anatomische Scheren
Anatomy scissors

Ciseaux à dissequer
Tijeras para anatomia
Forbici per anatomia



115 mm - 4½"	tk 9502-11	tk 9503-11
130 mm - 5"	tk 9502-13	tk 9503-13
140 mm - 5½"	tk 9502-14	tk 9503-14

Scheren
Scissors

Ciseaux
Tijeras
Forbici



TAYLOR

145 mm - 5¾"

tk 9517-14

1:2



SCHMIEDEN

170 mm - 6¾"

tk 9517-17

1:2

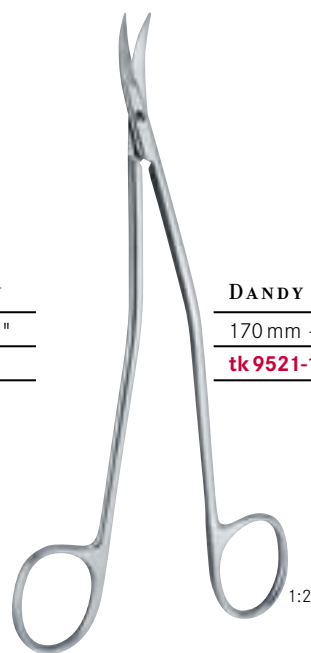

DANDY

170 mm - 6¾"

tk 9521-17

1:2



STRULLY

220 mm - 8¾"



1:2



1:2

tk 9518-22

tk 9519-22

1:2

Ligaturscheren
Ligature scissors

Ciseaux à ligatures
Tijeras para ligaduras
Forbici per sutura



LITTAUER

140 mm - 5½"

tk 9522-14

1:2



O'BRIEN

90 mm - 3½"

tk 9530-09

1:2

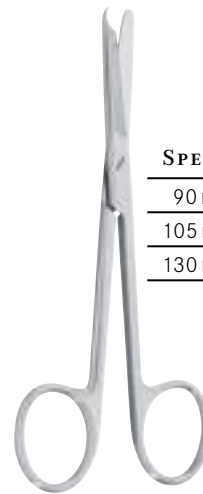

SPENCER

90 mm - 3½"

tk 9532-09

105 mm - 4¼"

tk 9532-10

130 mm - 5"

tk 9532-13



115 mm - 4½"

tk 9533-11

1:2

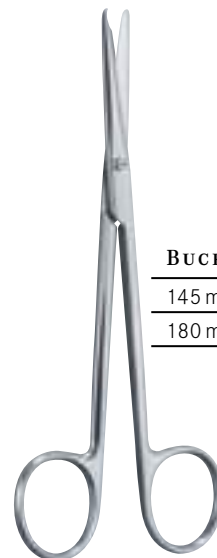

BUCK

145 mm - 5¾"

tk 9535-14

180 mm - 7"

tk 9535-18

Ligaturscheren
Ligature scissors

Ciseaux à ligatures
Tijeras para ligaduras
Forbici per sutura



NORTHBENT

90 mm - 3½"	tk 9542-09
125 mm - 5"	tk 9542-12



HEATH

150 mm - 6"	tk 9552-15
-------------	-------------------

gezahnt
saw edge
dentelés
dentada
dentata

1:2



120 mm - 4¾"	tk 9557-12
--------------	-------------------

gezahnt
saw edge
dentelés
dentada
dentata

1:2



EISELSBERG

110 mm - 4¼"	tk 9567-11
--------------	-------------------

1:2



105 mm - 4¼"	tk 9577-10
--------------	-------------------

1:2

Drahtscheren | Cisailles pour fils
Wire cutting scissors | Cizallas para cortar alambre
Forbici per filo metallico

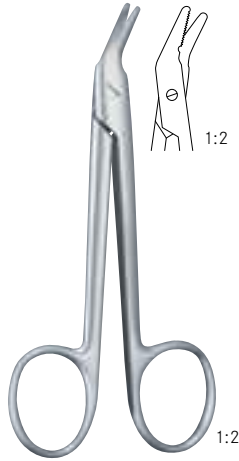

UNIVERSAL

120 mm – 4¾"

tk 9622-12

gezahnt
saw edge
 dentelés
dentada
 dentata



HARVEY

125 mm – 5"

tk 9632-12

gezahnt
saw edge
 dentelés
dentada
 dentata



SCHUHKNECHT

125 mm – 5"

tk 9637-12

gezahnt
saw edge
 dentelés
dentada
 dentata

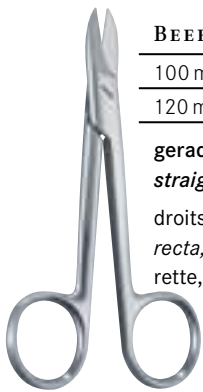

BEEBEE

100 mm – 4"

120 mm – 4¾"

gerade, gezahnt für weichen Draht bis ø 0,8 mm
straight, saw edge for soft wire up to ø 0.8 mm

droits, dentelée pour fils doux à ø 0.8 mm
recta, dentada para alambres blanda hasta ø 0.8 mm
 rette, dentata per filo morbido fino a ø 0.8 mm

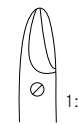
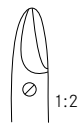

tk 9582-10

tk 9592-10

tk 9602-10

tk 9612-10

tk 9582-12

tk 9592-12

tk 9602-12

tk 9612-12

stumpf – stumpf
blunt – blunt

spitz – spitz
sharp – sharp

stumpf – stumpf, gezahnt
blunt – blunt, saw edge

spitz – spitz
sharp – sharp

mousse – mousse
roma – roma
 smussa – smussa

pointue – pointue
aguda – aguda
 acuta – acuta

mousse – mousse, dentelée
roma – roma, dentada
 smussa – smussa, dentata

pointue – pointue
aguda – aguda
 acuta – acuta

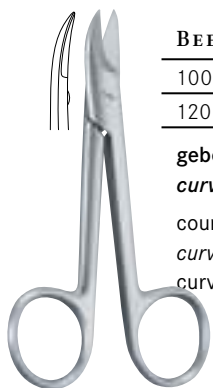

BEEBEE

100 mm – 4"

120 mm – 4¾"

gebogen, gezahnt für weichen Draht bis ø 0,8 mm
curved, saw edge for soft wire up to ø 0.8 mm

courbes, dentelée pour fils doux à ø 0.8 mm
curva, dentada para alambres blanda hasta ø 0.8 mm
 curve, dentata per filo morbido fino a ø 0.8 mm

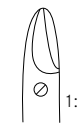
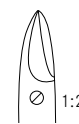
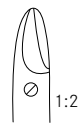

tk 9583-10

tk 9593-10

tk 9603-10

tk 9613-10

tk 9583-12

tk 9593-12

tk 9603-12

tk 9613-12

stumpf – stumpf
blunt – blunt

spitz – spitz
sharp – sharp

stumpf – stumpf, gezahnt
blunt – blunt, saw edge

spitz – spitz
sharp – sharp

mousse – mousse
roma – roma
 smussa – smussa

pointue – pointue
aguda – aguda
 acuta – acuta

mousse – mousse, dentelée
roma – roma, dentada
 smussa – smussa, dentata

pointue – pointue
aguda – aguda
 acuta – acuta

Verbandscheren
Bandage scissors

Ciseaux pour pansements
Tijeras para vendajes
Forbici per bendaggi



UNIVERSAL

150 mm - 6"	tk 9670-15
180 mm - 7"	tk 9670-18



LISTER

90 mm - 3½"	tk 9672-09
110 mm - 4¼"	tk 9672-11
140 mm - 5½"	tk 9672-14
160 mm - 6¼"	tk 9672-16
180 mm - 7"	tk 9672-18
200 mm - 8"	tk 9672-20



180 mm - 7"	tk 9674-18
200 mm - 8"	tk 9674-20

Verbandscheren
Bandage scissors

Ciseaux pour pansements
Tijeras para vendajes
Cesoie per bendaggi



LANGE
180 mm - 7"
tk 9697-18



KNOWLES
140 mm - 5½"
tk 9727-14



160 mm - 6¼"
tk 9702-16

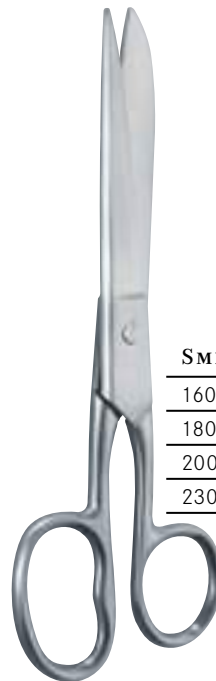

SMITH (MOD. USA)
160 mm - 6¼" **tk 9722-16**
180 mm - 7" **tk 9722-18**
200 mm - 8" **tk 9722-20**
230 mm - 9" **tk 9722-23**

Verband- und Gipsscheren
Bandage scissors - Plaster shears

Ciseaux pour pansements et plâtres
Tijeras para vendajes y vendajes enyesados
 Cesioie per bendaggi ed apparecchi gessati



ESMARCH	
200 mm - 8"	tk 9676-20
220 mm - 8¾"	tk 9676-22



EXCENTRIC	
160 mm - 6¼"	tk 9680-16
190 mm - 7½"	tk 9680-19

gezahnt
saw edge
 dentelés
dentadas
 dentate



BERGMANN	
230 mm - 9"	tk 9682-23

1:2



LORENZ	
230 mm - 9"	tk 9687-23

1:2

Gipsscheren
Plaster shears

Cisailles pour plâtres
Cizallas para vendajes enyesados
Cesoie per apparecchi gessati



BRUNS

240 mm - 9½"

tk 9712-24

tk 9714-24

gezahnt
saw edge
dentelés
dentadas
dentate



200 mm - 8"

tk 9732-20



230 mm - 9"

tk 9737-23

Hautscheren – Nagelscheren
Cuticle scissors – Nail scissors

Ciseaux à envies – Ciseaux à ongles
Tijeras cuticulares – Tijeras para uñas
 Forbici per unghie e cuticole

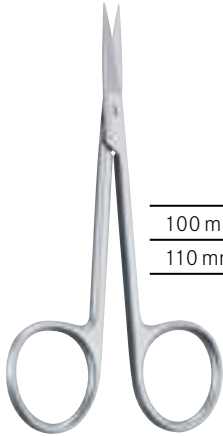

100 mm - 4"	tk 9982-10	tk 9983-10
110 mm - 4 1/4"	tk 9982-11	tk 9983-11

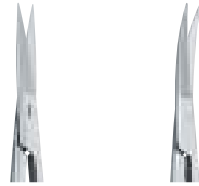

90 mm - 3 1/2"	tk 9992-09	tk 9993-09
100 mm - 4"	tk 9992-10	tk 9993-10
110 mm - 4 1/4"	tk 9992-11	tk 9993-11



Nagelspaltscheren
Nail splitting scissors

Ciseaux à ongles
Tijeras para uñas
 Forbici per unghie



130 mm - 5"	tk 9642-13
150 mm - 6"	tk 9642-15



SYSTRUNK		
130 mm - 5"	tk 9652-13	tk 9653-13

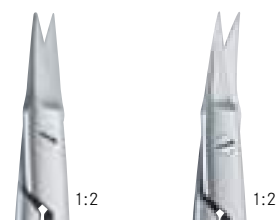

Nagelzangen
Nail nippers

Pincès à ongles
Pinzas corta-uñas
Forbici e tronchesine per unghie



110 mm - 4 1/4"	tk 9974-11
130 mm - 5"	tk 9974-13
150 mm - 6"	tk 9974-15



140 mm - 5 1/2"	tk 9976-14
-----------------	-------------------



140 mm - 5 1/2"	tk 9977-14
-----------------	-------------------



TURNBULL

115 mm - 4 1/2"	tk 9978-11
130 mm - 5"	tk 9978-13



100 mm - 4"	tk 9960-10
-------------	-------------------



COHEN

100 mm - 4"	tk 9962-10
-------------	-------------------

Scheren mit Hartmetallschneiden
Scissors with tungsten-carbide inserts

Ciseaux avec inserts de carbure de tungstène
Tijeras con filo en carburo de tungsteno
Forbici con inserti al carburo di tungsteno



Alle Scheren mit „tucar“ Hartmetallschneiden zeichnen sich durch eine über lange Zeit gleichmäßige weiche und dauerhafte Schnittfähigkeit aus. Alle Scheren mit Hartmetallschneiden haben zur Kennzeichnung vergoldete Ringe.

All scissors with “tucar” tungsten carbide cutting edges are distinguished by a uniform, smooth and longlasting cut. Scissors having tungsten carbide cutting edges are identified by gold plated rings

Tous les ciseaux munis de lames «tucar» en carbure de tungstène se distinguent par leur coupe uniforme, souple et durable. Les ciseaux avec tranchants en carbure de tungstène se reconnaissent par leurs anneaux dorés.

Todas las tijeras dotadas de hojas “tucar” de carburo de tungsteno son distinguidas por su corte uniforme, suave y durable. Tijeras con corte de carburo de tungsteno se reconocen por la doradura de sus anillos.

Tutte le forbici con taglio di tungsteno permettono un taglio uniforme per un tempo prolungato. Tutte le forbici “tucar”, cioè con le lame di Tungsteno, hanno gli anelli d’orati.

Chirurgische Scheren
Operating scissors

Ciseaux à chirurgie
Tijeras para cirugía
Forbici per chirurgia

TUCARTK



STANDARD

	Fig. 1	Fig. 2	Fig. 3
145 mm - 5¾"	tk 8027-14	tk 8028-14	tk 8029-14
165 mm - 6½"	tk 8027-16	tk 8028-16	tk 8029-16



STANDARD

	Fig. 1	Fig. 2	Fig. 3
145 mm - 5¾"	tk 8037-14	tk 8038-14	tk 8039-14
165 mm - 6½"	tk 8037-16	tk 8038-16	tk 8039-16



LEXER

165 mm - 6¼"	tk 8138-16	tk 8139-16
210 mm - 8¼"	tk 8138-21	tk 8139-21



Chirurgische Scheren – Präparierscheren
Operating scissors – Dissecting scissors

Ciseaux à chirurgie – Ciseaux à dissection
Tijeras para cirugía – Tijeras de disección
 Forbici per chirurgia – Forbici per dissezione



MAYO

145 mm – 5 ³ / ₄ "	tk 8278-14	tk 8279-14
170 mm – 6 ³ / ₄ "	tk 8278-17	tk 8279-17
230 mm – 9"	tk 8278-23	tk 8279-23

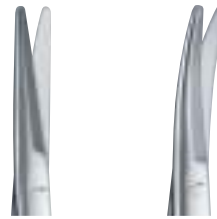

MAYO-STILLE

150 mm – 6"	tk 8288-15	tk 8289-15
170 mm – 6 ³ / ₄ "	tk 8288-17	tk 8289-17



Chirurgische Scheren – Präparierscheren
Operating scissors – Dissecting scissors

Ciseaux à chirurgie – Ciseaux à dissection
Tijeras para cirugía – Tijeras de disección
Forbici per chirurgia – Forbici per dissezione

TUCARTK

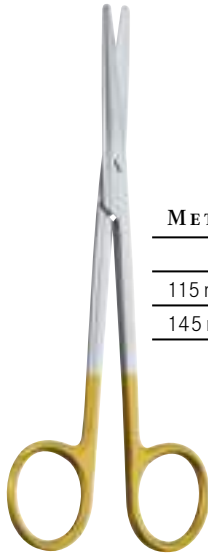

METZENBAUM

	Fig. 1	Fig. 2	Fig. 3
115 mm - 4½"	tk 8327-11		
145 mm - 5¾"	tk 8327-14	tk 8328-14	tk 8329-14

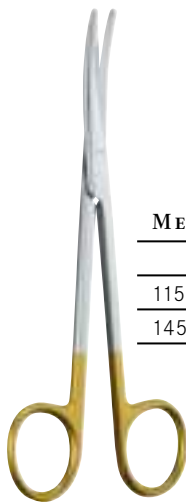

METZENBAUM

	Fig. 1	Fig. 2	Fig. 3
115 mm - 4½"	tk 8337-11		
145 mm - 5¾"	tk 8337-14	tk 8338-14	tk 8339-14



Chirurgische Scheren – Präparierscheren
Operating scissors – Dissecting scissors

Ciseaux à chirurgie – Ciseaux à dissection
 Tijeras para cirugía – Tijeras de disección
 Forbici per chirurgia – Forbici per dissezione



**METZENBAUM-
NELSON**

	Fig. 1	Fig. 2	Fig. 3
180 mm – 7"	tk 8347-18	tk 8348-18	tk 8349-18
200 mm – 8"	tk 8347-20	tk 8348-20	tk 8349-20
230 mm – 9"	tk 8347-23	tk 8348-23	tk 8349-23
250 mm – 10"	tk 8347-25		
280 mm – 11"	tk 8347-28		
300 mm – 12"	tk 8347-30		



**METZENBAUM-
NELSON**

	Fig. 1	Fig. 2	Fig. 3
180 mm – 7"	tk 8357-18	tk 8358-18	tk 8359-18
200 mm – 8"	tk 8357-20	tk 8358-20	tk 8359-20
230 mm – 9"	tk 8357-23	tk 8358-23	tk 8359-23
250 mm – 10"	tk 8357-25		
280 mm – 11"	tk 8357-28		
300 mm – 12"	tk 8357-30		
350 mm – 14"	tk 8357-35		



Chirurgische Scheren – Präparierscheren
Operating scissors – Dissecting scissors

Ciseaux à chirurgie – Ciseaux à dissection
Tijeras para cirugía – Tijeras de disección
Forbici per chirurgia – Forbici per dissezione

TUCARTK



**METZENBAUM-
FINO**



1:2



1:2

	Fig. 1	Fig. 1
145 mm – 5¾"	tk8363-14	tk8365-14



**METZENBAUM-
FINO**



1:2



1:2

	Fig. 3	Fig. 3
145 mm – 5¾"	tk8366-14	tk8367-14

Präparierscheren
Dissecting scissors

Ciseaux à dissection
Tijeras de disección
Forbici per dissezione

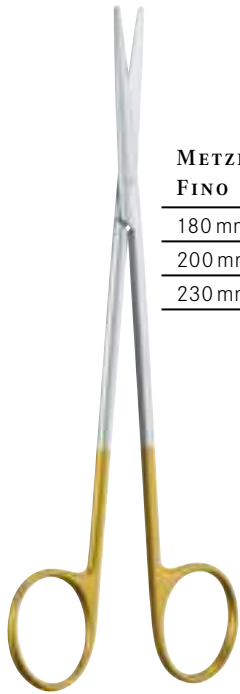

METZENBAUM-FINO

180 mm - 7"	tk 8370-18	tk 8371-18
200 mm - 8"	tk 8370-20	tk 8371-20
230 mm - 9"	tk 8370-23	tk 8371-23

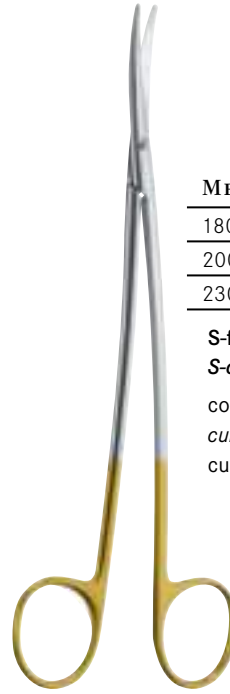

METZENBAUM-FINO

180 mm - 7"	tk 9725-18
200 mm - 8"	tk 9725-20
230 mm - 9"	tk 9725-23

S-förmig gebogen
S-curved

courbes en S
curva en S
curve a forma di S

Feine Scheren
Fine scissors

Ciseaux fins
Tijeras finas
Forbici fini



LOCKLIN

165 mm - 6½"	tk 8591-16	tk 8589-16
--------------	------------	------------

gerade, gezahnt
straight, saw edge
droits, dentelés
recta, dentada
rette, dentate

gebogen, gezahnt
curved, saw edge
courbes, dentelés
curva, dentada
curve, dentate

Scheren für die Plastische Chirurgie
Plastic surgery scissors

Ciseaux pour la chirurgie plastique
Tijeras para la cirugía plástica
Forbici per chirurgia plastica

TUCARTK

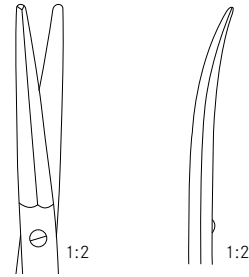

GORNEY

200 mm - 8"	tk 8702-20	tk 8703-20
230 mm - 9"	tk 8702-23	tk 8703-23



KAYE

115 mm - 4½"	tk 8696-11
--------------	-------------------



KILNER (RAGNELL)

120 mm - 4¾"	tk 8698-12
150 mm - 6"	tk 8698-15



Bitte fordern Sie unseren Spezialkatalog für Plastische Chirurgie an.
Please ask for our special catalogue for plastic surgery.

Veuillez demander pour notre catalogue spécial pour la chirurgie plastique.
Por favor preguntan para el catalogo especial para la cirugía plástica.

Per favore domandate per il nostro catalogo speciale per la chirurgia plastica.

Gefäßscheren
Artery scissors

Ciseaux vasculaires
Tijeras vasculares
Forbici vascolari

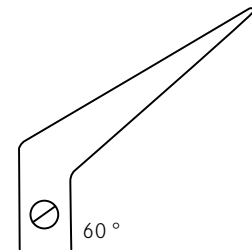
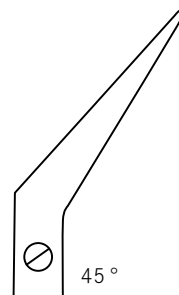
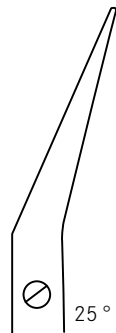

DE BAKEY

160 mm - 6¼"	tk 8775-16	tk 8776-16	tk 8777-16
230 mm - 9"	tk 8775-23	tk 8776-23	tk 8777-23
280 mm - 11"	tk 8775-28	tk 8776-28	tk 8777-28

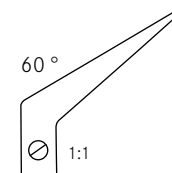
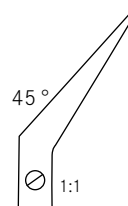
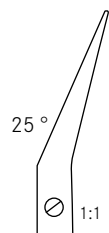

POTTS-
DE MARTEL

190 mm - 7½"	tk 8773-25	tk 8773-45	tk 8773-60
--------------	------------	------------	------------

Tonsillenscheren
Tonsil scissors

Ciseaux pour les amygdales
Tijera para amigdales
Forbici per tonsille

TUCARTK



TOENNIS-
ADSON

170 mm - 6³/₄"

tk9718-17

1:2



DEAN

170 mm - 6³/₄"

tk8859-17

gebogen, gezahnt
curved, saw edge

courbes, dentelés
curvas, dentadas
curve, dentate

1:2

Parametriumscheren
Parametrium scissors

Parametrium ciseaux
Parametrium tijera
Forbici per il parametrio

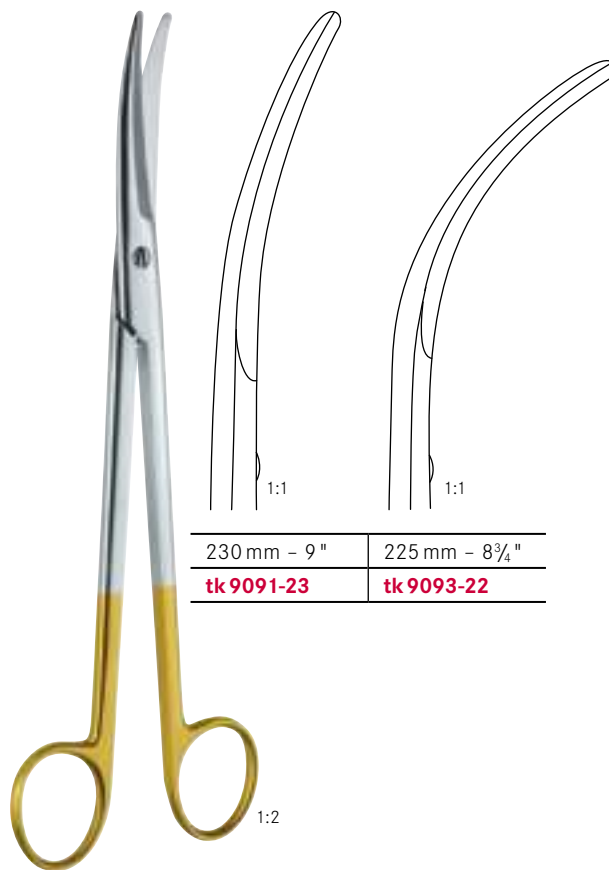

230 mm - 9"	225 mm - 8¾"
tk 9091-23	tk 9093-22

Irisscheren
Iris scissors

Ciseaux à iridectomie
Tijeras para iridectomia
Forbici per iridectomia

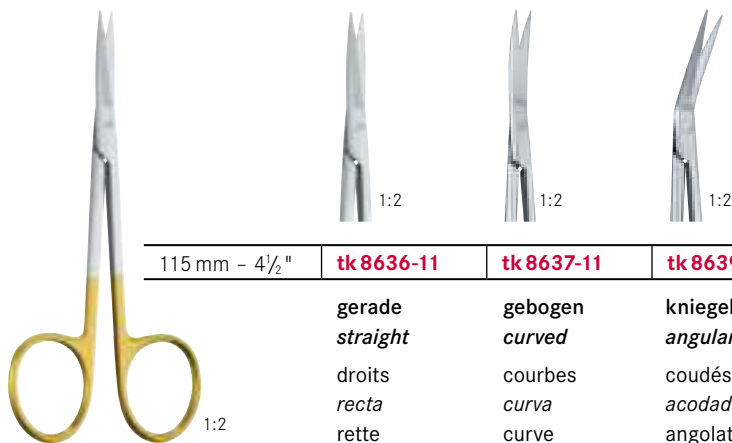

115 mm - 4½"	tk 8636-11	tk 8637-11	tk 8639-11
gerade <i>straight</i>	gebogen <i>curved</i>	kniegebogen <i>angular</i>	
droits <i>recta</i> rette	courbes <i>curva</i> curve	coudés <i>acodada</i> angolata	

Drahtschere
Wire cutting scissors

Cisaille pour fils
Cizalla para cortar alambre
Forbice per filo metallico

TUCARTK



UNIVERSAL

120 mm - 4³/₄"

tk 9629-12

Verbandscheren
Bandage scissors

Ciseaux pour pansements
Tijeras para vendajes
Forbici per bendaggi



LISTER

180 mm - 7"

tk 9677-18



BRUNS

240 mm - 9¹/₂"

tk 9716-24

SUPERCUT^{TK}

SuperCut Scheren (SU) SuperCut scissors (SU)

Ciseaux SuperCut (SU)
SuperCut tijeras (SU)
Forbici con taglio SuperCut (SU)



Ein äußerst scharfer Osteotomschliff am oberen Scherenblatt gewährt das leichte Abscheren des Gewebes. Das zweite Scherenblatt ist leicht gezahnt, um das Abrutschen des Gewebes zu vermeiden. SuperCut-Scheren sind an den schwarzen Ringen zu erkennen. Auf Wunsch kann jedes andere Modell in SuperCut geliefert werden. Auf Wunsch können SuperCut Scheren auch ohne Zahnung geliefert werden.

An extremely sharp osteotome cut on the upper blade guarantees easy and precise cutting of the tissue. The other blade is slightly serrated for fixing the tissue. SuperCut scissors are indicated by black rings. Any other tekno scissors can be supplied as tekno SuperCut upon request. SuperCut scissors can be supplied upon request without serration.

L'aiguillage extrêmement coupante «osteotome» de la lame supérieure, garantit une coupure facile et précise du tissu. La deuxième lame est légèrement dentelée pour tenir le tissu. Ciseaux SuperCut peuvent être identifiés par les anneaux noirs. Tous les autres ciseaux peuvent être fournis en version SuperCut sur demande. Les ciseaux SuperCut peuvent être fournis également non dentelés sur demande.

A través de un filo de "osteotomo" extremo agudo de una hoja es posible cortar fácilmente precisamente el tejido. La segunda hoja tiene dientes muy suaves para evitar que se deslice el tejido. Las tijeras SuperCut se reconocen por sus anillos negros. Todas las otras tijeras pueden ser producidas en SuperCut según demanda. Las tijeras SuperCut pueden ser producidas también sin dientes según demanda.

La affilatura speciale della lama superiore a forma di osteotomo dà un taglio estremamente facile e preciso. Una leggera dentatura sulla seconda lama evita che il tessuto scivoli. Per distinguersi dalle altre forbici, le forbici SuperCut hanno due anelli neri. Se richiesto le forbici SuperCut si forniscono pure senza la zigrinatura su una lama. Se richiesto ogni altro modello di forbici può essere fornito con taglio SuperCut.

Chirurgische Scheren
Operating scissors

Ciseaux à chirurgie
Tijeras para cirugía
Forbici per chirurgia

SUPERCUT



LEXER

160 mm - 6¼"	tk 8122-16 SU	tk 8123-16 SU
--------------	----------------------	----------------------



MAYO

140 mm - 5½"	tk 8272-14 SU	tk 8273-14 SU
150 mm - 6¾"	tk 8272-15 SU	tk 8273-15 SU
170 mm - 6¾"	tk 8272-17 SU	tk 8273-17 SU
230 mm - 9"	tk 8272-23 SU	tk 8273-23 SU



MAYO-STILLE

150 mm - 6"	tk 8282-15 SU	tk 8283-15 SU
170 mm - 6¾"	tk 8282-17 SU	tk 8283-17 SU

Chirurgische Scheren
Operating scissors

Ciseaux à chirurgie
Tijeras para cirugía
Forbici per chirurgia



METZENBAUM

145 mm - 5 3/4"	tk 8323-14 SU	tk 8333-14 SU
-----------------	---------------	---------------

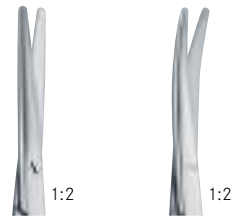

METZENBAUM-
NELSON

	Fig. 1	Fig. 1
180 mm - 7"	tk 8343-18 SU	tk 8353-18 SU
200 mm - 8"	tk 8343-20 SU	tk 8353-20 SU
230 mm - 9"	tk 8343-23 SU	tk 8353-23 SU

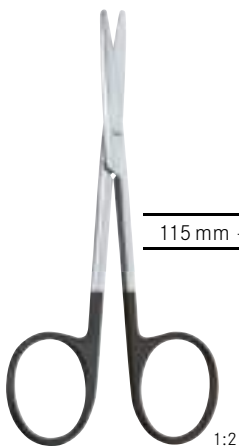

115 mm - 4 1/2"	tk 9482-11 SU	tk 9483-11 SU
-----------------	---------------	---------------

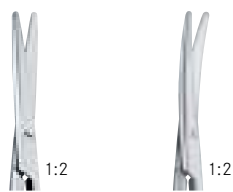

KILNER (RAGNELL)

120 mm - 4 3/4"	tk 8697-12 SU
150 mm - 6"	tk 8697-15 SU
180 mm - 7"	tk 8697-18 SU
200 mm - 8"	tk 8697-20 SU



Chirurgische Scheren
Operating scissors

Ciseaux à chirurgie
Tijeras para cirugía
Forbici per chirurgia

SUPERCUT

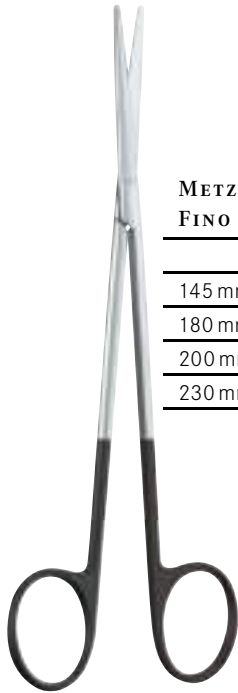

**METZENBAUM-
FINO**



	Fig. 1	Fig. 2
145 mm - 5 3/4"	tk 8372-14 SU	tk 8373-14 SU
180 mm - 7"	tk 8380-18 SU	tk 8381-18 SU
200 mm - 8"	tk 8380-20 SU	tk 8381-20 SU
230 mm - 9"	tk 8380-23 SU	tk 8381-23 SU



115 mm - 4 1/2"	tk 9432-11 SU	tk 9434-11 SU
-----------------	----------------------	----------------------

Chirurgische Scheren
Operating scissors

Ciseaux à chirurgie
Tijeras para cirugía
Forbici per chirurgia

SUPERCUT^{TK}



1:2

**GOLDMANN-
FOX**

130 mm - 5"



1:2

tk 9922-13 SU



1:2

tk 9923-13 SU



1:2

JOSEPH

140 mm - 5½"



1:2

tk 8692-14 SU



1:2

tk 8693-14 SU

Chirurgische Scheren
Operating scissors

Ciseaux à chirurgie
Tijeras para cirugía
Forbici per chirurgia

SUPERCUT

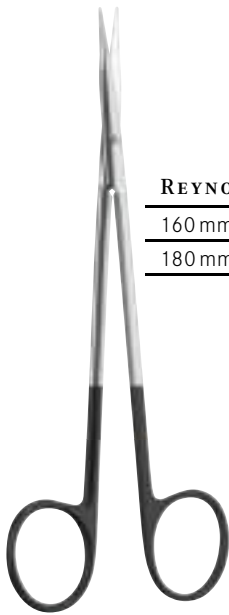

REYNOLDS

160 mm - 6 $\frac{1}{4}$ "	tk 8602-16 SU	tk 8603-16 SU
180 mm - 7"	tk 8602-18 SU	tk 8603-18 SU



STEVENS

100 mm - 4"	tk 9462-10 SU	tk 9463-10 SU
110 mm - 4 $\frac{1}{4}$ "	tk 9462-11 SU	tk 9463-11 SU

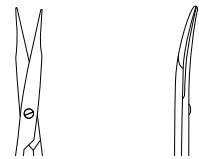

FOMON

130 mm - 5"

tk 9152-13 SU

1:2



SerratedCut Scheren (SR)
SerratedCut scissors (SR)

Ciseaux SerratedCut (SR)
SerratedCut tijeras (SR)
Forbici con taglio SerratedCut (SR)



Die Scheren der TEKNO „SerraTK“ Linie verfügen über ein gezahntes Schneideblatt. Die feine Zahnung ist ein Garant für präzises Schneiden auch in schwieriger Umgebung und stellt sicher dass Gewebes oder Nahtmaterial beim Schneiden nicht aus dem Schnitt gleitet. Das nachfolgende „SerraTK“ Programm umfasst geläufige Modelle, welche gerne in gezahnter Ausführung eingesetzt werden. Auf Wunsch fertigen wir auch weitere Scheren aus unserem Programm mit „SerraTK“ Zahnung. Selbstverständlich lässt sich die „SerraTK“ Zahnung mit jeglicher Scherenart, wie TC, Super Cut, etc., kombinieren.

Scissors of TEKNO „SerraTK“ Line do have a serrated cutting blade. The delicate toothing guarantees a precious cutting also in difficult surroundings and ensures that the tissue or suture material does not slide out of the incision while cutting. The subsequent „SerraTK“ program covers common models, which are often requested in a toothed design. On demand we are also pleased to produce other models of our program with „SerraTK“ toothing. Obviously the „SerraTK“ toothing can be combined with each scissors model, e.g. TC, SuperCut, etc.

Les ciseaux de la ligne TEKNO «SerraTK» ont une lame de coupe dentelée. La denture fine est une garantie pour une coupe précise, même dans des environnements difficiles. La denture fine est une garantie pour une coupe précise, même dans des environnements difficiles et assure que le tissu ou la suture lors de la coupe ne glissent pas hors de la coupe. Le programme ultérieur «de SerraTK» comprend des modèles communs, qui sont souvent utilisés dans l'exécution dentée. Sur demande, nous fabriquons des autres ciseaux de notre programme avec denture «SerraTK». Bien sûr, la denture «SerraTK» peut être combiné avec tout type de ciseaux comme TC, Super Cut, etc.

Las tijeras de la línea TEKNO “SerraTK” tienen una cuchilla de corte dentado. El fino dentado es una garantía para el corte preciso incluso en entornos difíciles y asegura que el tejido o la sutura durante el corte no se deslice fuera del corte. El subsiguiente programa “SerraTK” incluye modelos comunes, los que pueden emplearse en terminación dentada. A petición fabricamos también otras tijeras de nuestro programa con el dentado SerraTK. Por supuesto el dentado “SerraTK” puede ser con combinado con cualquier tipo de tijeras como TC, Super Cut, etc.

Le forbici “SerraTK” sono caratterizzate da una lama zigrinata. Questa zigrinatura evita che i tessuti oppure i materiali da sutura scivolino e vengano tagliati. Quasi tutte le forbici possono essere fornite zigrinate, sia Standard che Tucar (TC). Nel ns. programma/catalogo trovate una selezione di forbici “SerraTK”. Queste forbici sono identificate dalle lettere “SR” dopo il numero di articolo.

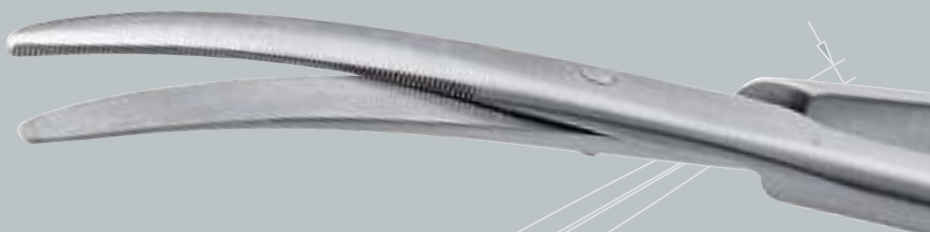

Chirurgische Scheren
Operating scissors

Ciseaux à chirurgie
Tijeras para cirugía
Forbici per chirurgia

SERRATK



115 mm - 4½" **tk8637-11 SR**

gebogen
curved
courbes
curva
curve



1:2

1:2



MAYO

170 mm - 6¾" **tk8279-17 SR**

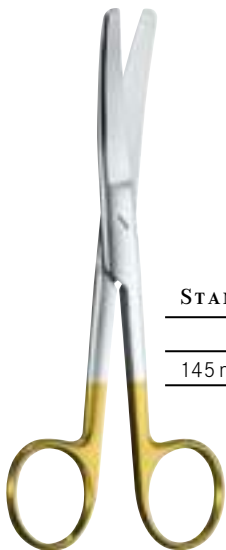

STANDARD

145 mm - 5¾" **tk8037-14 SR**



Fig. 1



LEXER

165 mm - 6¼" **tk8139-16 SR**



Chirurgische Scheren
Operating scissors

Ciseaux à chirurgie
Tijeras para cirugía
Forbici per chirurgia



METZENBAUM-FINO

1:2

	Fig. 1
145 mm - 5¾"	tk 8365-14 SR



TOENNIS-ADSON

170 mm - 6¾"

tk 9718-17 SR



METZENBAUM-NELSON



	Fig. 1
180 mm - 7"	tk 8357-18 SR
200 mm - 8"	tk 8357-20 SR
230 mm - 9"	tk 8357-23 SR
250 mm - 10"	tk 8357-25 SR



METZENBAUM



	Fig. 1
145 mm - 5¾"	tk 8337-14 SR

Chirurgische Scheren
Operating scissors

Ciseaux à chirurgie
Tijeras para cirugía
Forbici per chirurgia

SERRATK



**METZENBAUM-
FINO**

180 mm - 7"	tk 8371-18 SR
200 mm - 8"	tk 8371-20 SR
230 mm - 9"	tk 8371-23 SR

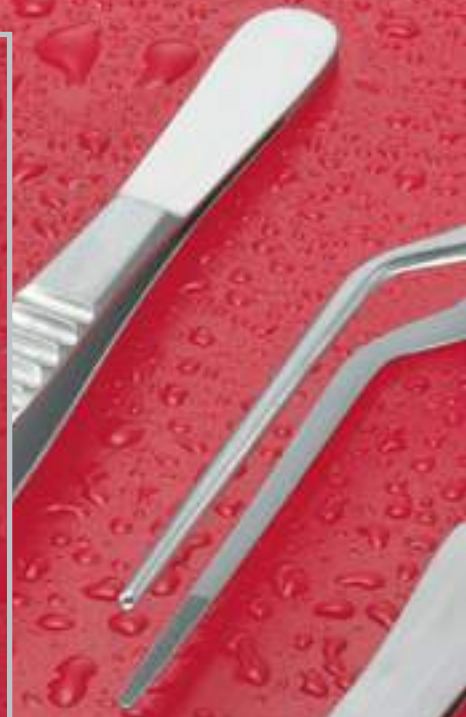

Pinzetten | Pincas
Forceps | *Pinzas*
Pinze

Anatomische Pinzetten | Pincés à dissection
Dressing forceps | *Pinzas de disección*
 Pinze anatomiche

! Atraumatische Pinzetten sind abgebildet von Seite 168, 394 bis 396, 626
Atraumatic forceps, please see the pages 168, 394 to 396, 626
 Pincés atraumáticas, voire pages 168, 394 à 396, 626
Pinzas atraumáticas, ver paginas 168, 394 a 396, 626
 Pinze atraumatiche, vedete pagina 168, 394 a 396, 626



STANDARD

105 mm - 4 1/4"	tk 10000-10	tk 10100-10	tk 10001-10
115 mm - 4 1/2"	tk 10000-11	tk 10100-11	tk 10001-11
130 mm - 5"	tk 10000-13	tk 10100-13	tk 10001-13
145 mm - 5 3/4"	tk 10000-14	tk 10100-14	tk 10001-14
150 mm - 6"	tk 10000-15	tk 10100-15	
160 mm - 6 1/4"	tk 10000-16	tk 10100-16	tk 10001-16
180 mm - 7"	tk 10000-18	tk 10100-18	tk 10001-18
200 mm - 8"	tk 10000-20	tk 10100-20	tk 10001-20
250 mm - 10"	tk 10000-25	tk 10100-25	tk 10001-25
300 mm - 12"	tk 10000-30	tk 10100-30	tk 10001-30
350 mm - 14"	tk 10000-35		

schmal
narrow
 étroite
estrecha
 strette

Anatomische Pinzetten
Dressing forceps

Pincers à dissection
Pinzas de disección
Pinze anatomiche



130 mm - 5"	tk 10102-13
145 mm - 5¾"	tk 10102-14
160 mm - 6¼"	tk 10102-16

kreuzgerieft
cross serated
striée
estriada
zigrinato a croce

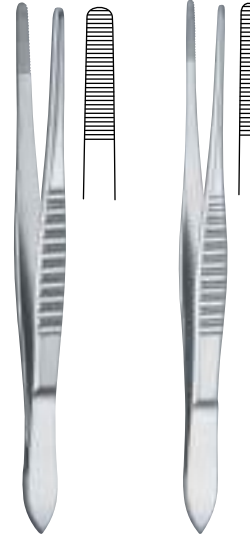

MOD. USA

120 mm - 4¾"	tk 10150-12	tk 10155-12
130 mm - 5"	tk 10150-13	tk 10155-13
145 mm - 5¾"	tk 10150-14	tk 10155-14
155 mm - 6"	tk 10150-15	tk 10155-15
180 mm - 7"	tk 10150-18	
210 mm - 8¼"	tk 10150-21	
250 mm - 9¾"	tk 10150-25	
310 mm - 12¼"	tk 10150-31	

schmal
narrow
étroite
estrecha
strette

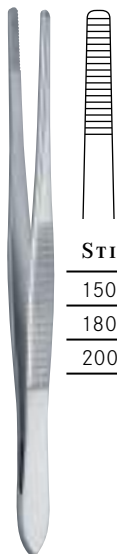

STILLE

150 mm - 6"	tk 10200-15
180 mm - 7"	tk 10200-18
200 mm - 8"	tk 10200-20



SEMKEN

125 mm - 5"	tk 10300-12
150 mm - 6"	tk 10300-15

Anatomische Pinzetten
Dressing forceps

Pinces à dissection
Pinzas de disección
Pinze anatomiche

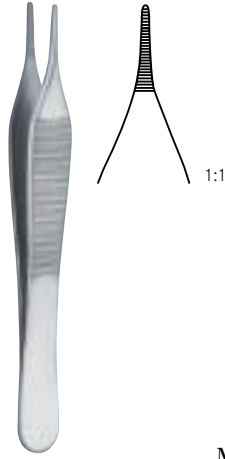

ADSON

120 mm - 4 3/4"	tk 10500-12
150 mm - 6"	tk 10500-15

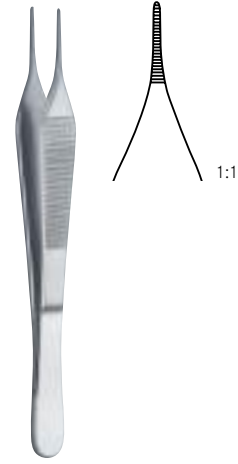

MICRO-ADSON

120 mm - 4 3/4"	tk 10503-12
150 mm - 6"	tk 10503-15



ADSON

120 mm - 4 3/4"	tk 10509-12
-----------------	--------------------

kreuzgerieft
cross serrated
striée
estriada
zigrinato a croce



HUDSON
(EWALD)

120 mm - 4 3/4"	tk 10505-12
-----------------	--------------------

Anatomische Pinzetten
Dressing forceps

Pincès à dissection
Pinzas de disección
Pinze anatomiche



CUSHING

175 mm - 7"

tk 10400-17

tk 10401-17



MC INDOE

150 mm - 6"

tk 10550-15



BROPHY

200 mm - 8"

tk 10600-20

tk 10601-20



DUEHRSEN

200 mm - 8"

tk 10604-20

Anatomische Pinzetten
Dressing forceps

Pinces à dissection
Pinzas de disección
Pinze anatomiche



WANGENSTEEN

150 mm - 6"	tk 10608-15
230 mm - 9"	tk 10608-23



WAUGH

150 mm - 6"	tk 10616-15
200 mm - 8"	tk 10616-20
250 mm - 9¾"	tk 10616-25



POTTS-SMITH

180 mm - 7"	tk 10650-18	tk 10651-18
210 mm - 8¼"	tk 10650-21	tk 10651-21
250 mm - 9¾"	tk 10650-25	tk 10651-25

Anatomische Pinzetten
Dressing forceps

Pinces à dissection
Pinzas de disección
Pinze anatomiche



TAYLOR

175 mm - 7"

tk 10310-17

tk 10312-17

tk 10313-17

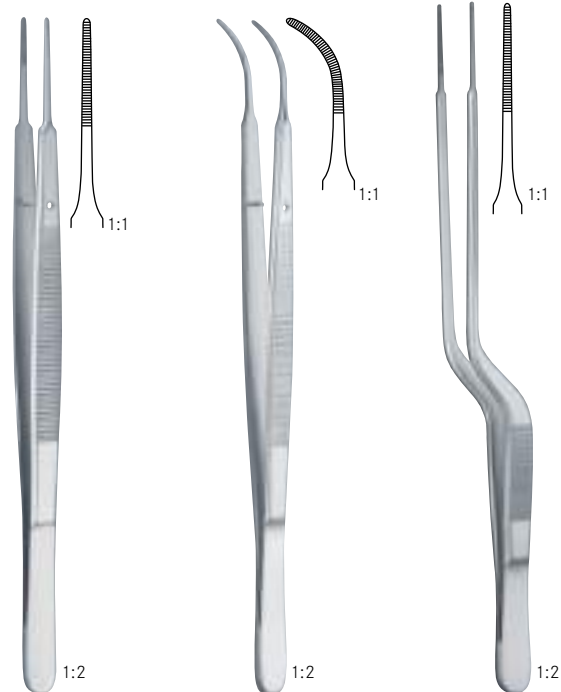

GERALD

180 mm - 7"

tk 10324-18

tk 10325-18

tk 10326-19

Chirurgische Pinzetten
Tissue forceps

Pinces à dissection à griffes
Pinzas de disección con dientes
Pinze chirurgiche

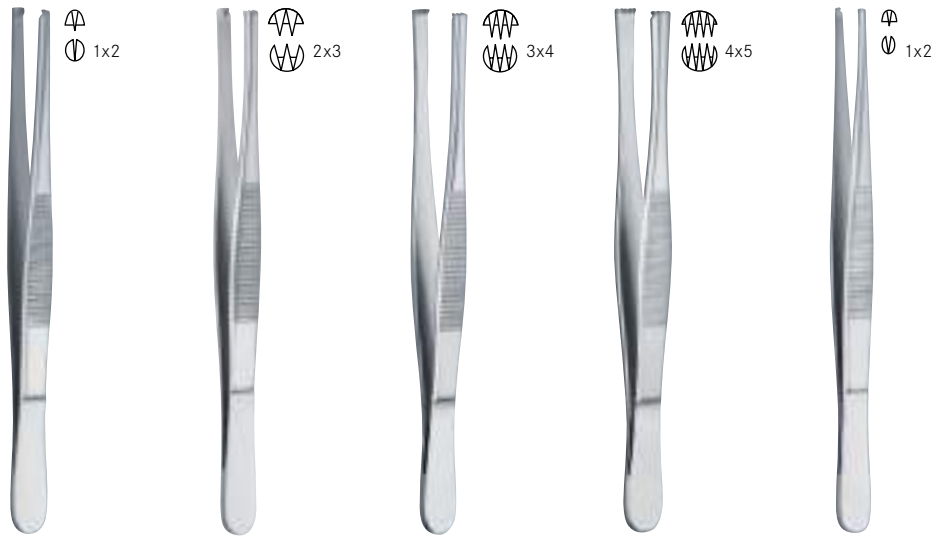

STANDARD

105 mm - 4 1/4 "	tk 11000-10	tk 11034-10			
115 mm - 4 1/2 "	tk 11000-11	tk 11034-11			tk 11060-11
130 mm - 5 "	tk 11000-13	tk 11034-13	tk 11043-13	tk 11054-13	tk 11060-13
145 mm - 5 3/4 "	tk 11000-14	tk 11034-14	tk 11043-14	tk 11054-14	tk 11060-14
150 mm - 6 "	tk 11000-15	tk 11034-15			
160 mm - 6 1/4 "	tk 11000-16	tk 11034-16	tk 11043-16	tk 11054-16	tk 11060-16
180 mm - 7 "	tk 11000-18	tk 11034-18			tk 11060-18
200 mm - 8 "	tk 11000-20	tk 11034-20			tk 11060-20
250 mm - 9 3/4 "	tk 11000-25	tk 11034-25	tk 11043-25		tk 11060-25
300 mm - 12 "	tk 11000-30	tk 11034-30	tk 11043-30		
350 mm - 14 "	tk 11000-35				

schmal
narrow
étroite
estrecha
stretta

Chirurgische Pinzetten
Tissue forceps

Pinces à dissection à griffes
Pinzas de disección con dientes
Pinze chirurgiche



STILLE

MOD. USA

150 mm - 6"	tk 11065-15	tk 11067-15
-------------	--------------------	--------------------

120 mm - 4¾"	tk 11080-12
130 mm - 5"	tk 11080-13
145 mm - 5¾"	tk 11080-14
155 mm - 6"	tk 11080-15
185 mm - 7"	tk 11080-18
210 mm - 8"	tk 11080-21
250 mm - 9¾"	tk 11080-25
310 mm - 12¼"	tk 11080-31



STONE

150 mm - 6"	tk 11083-15
-------------	--------------------



LERCHE

150 mm - 6"	tk 11085-15
-------------	--------------------

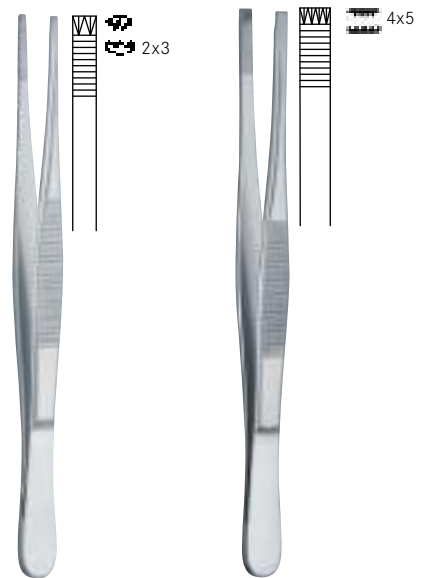

ADLERKREUTZ

150 mm - 6"	tk 11086-15	tk 11087-15
200 mm - 8"	tk 11086-20	tk 11087-20
250 mm - 9¾"		tk 11087-25

Chirurgische Pinzetten
Tissue forceps

Pinces à dissection à griffes
Pinzas de disección con dientes
Pinze chirurgiche

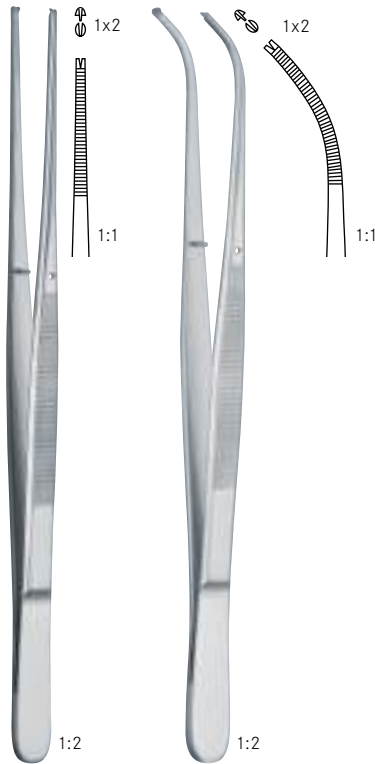

BROPHY

200 mm - 8"	tk 11100-20	tk 11101-20
-------------	--------------------	--------------------



POTTS-SMITH

180 mm - 7"	tk 11150-18	tk 11151-18
210 mm - 8 1/4"	tk 11150-21	tk 11151-21
250 mm - 9 3/4"	tk 11150-25	tk 11151-25

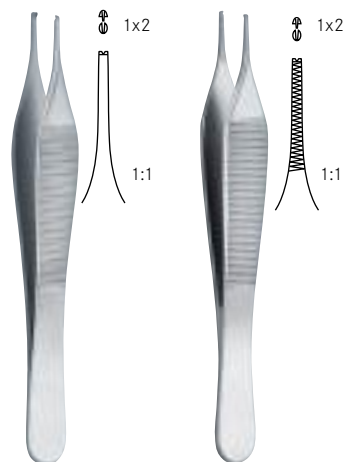

ADSON

120 mm - 4 3/4"	tk 11200-12	tk 11204-12
150 mm - 6"	tk 11200-15	



**ADSON-
GRAEFE**

120 mm - 4 3/4"	tk 11212-12
-----------------	--------------------

Chirurgische Pinzetten
Tissue forceps

Pinces à dissection à griffes
Pinzas de disección con dientes
Pinze chirurgiche

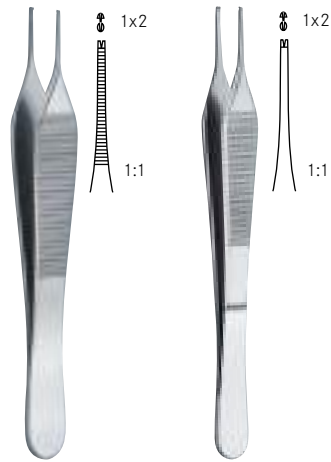

ADSON-MICRO

120 mm - 4¾"	tk 11202-12	tk 11206-12
150 mm - 6"	tk 11202-15	tk 11206-15

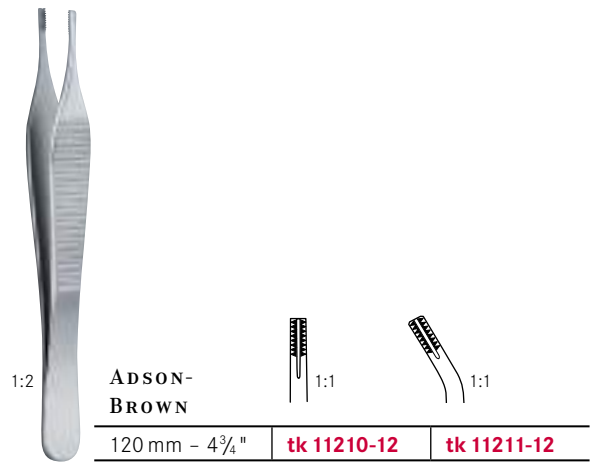

ADSON-BROWN

120 mm - 4¾"	tk 11210-12	tk 11211-12
--------------	--------------------	--------------------



HUDSON
(EWALD)

120 mm - 4"	tk 11505-12
-------------	--------------------



ADSON

120 mm - 4¾"	tk 11206-13
--------------	--------------------



ULTRA-MICRO-ADSON
(BRAKA)

120 mm - 4¾"	tk 11206-12B
--------------	---------------------

Chirurgische Pinzetten
Tissue forceps

Pinces à dissection à griffes
Pinzas de disección con dientes
Pinze chirurgiche



GILLIES
150 mm - 6"
tk 11250-15



SEMKEN
125 mm - 5" tk 11300-12
150 mm - 6" tk 11300-15



DUVAL
145 mm - 5 3/4"
tk 11314-14

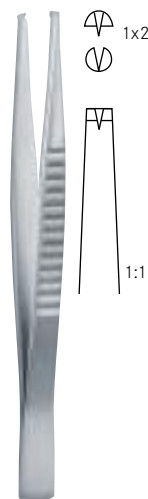

TREVES
125 mm - 5" tk 11338-12
150 mm - 6" tk 11338-15

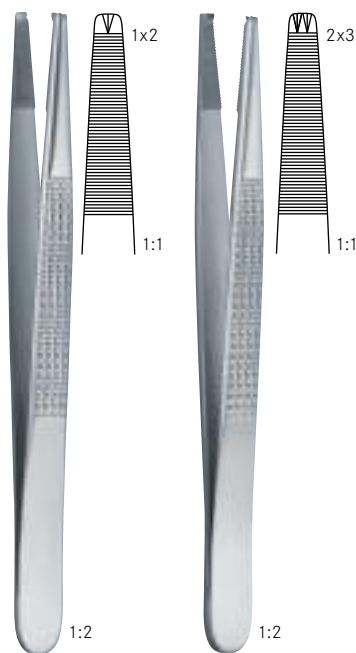

BONNEY
175 mm - 7" tk 11335-18 tk 11336-18



FERRIS-SMITH
180 mm - 7" tk 11320-18 tk 11322-18

Chirurgische Pinzetten
Tissue forceps

Pinces à dissection à griffes
Pinzas de disección con dientes
Pinze chirurgiche

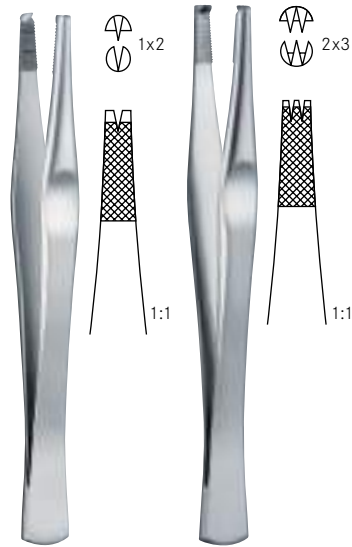

LANE

145 mm - 5 1/2"	tk 11340-14	tk 11341-14
200 mm - 8"	tk 11340-20	tk 11341-20



BROWN

150 mm - 6"	tk 11343-15
200 mm - 8"	tk 11343-20
250 mm - 9 3/4"	tk 11343-25

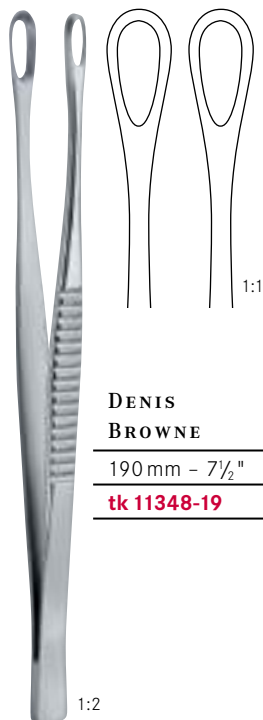

DENIS
BROWNE

190 mm - 7 1/2"
tk 11348-19



WAUGH

150 mm - 6"	tk 11349-15
200 mm - 8"	tk 11349-20
250 mm - 9 3/4"	tk 11349-25

Chirurgische Pinzetten
Tissue forceps

Pinces à dissection à griffes
Pinzas de disección con dientes
Pinze chirurgiche



STILLE-BARRAYA	
180 mm - 7"	tk 11330-18
200 mm - 8"	tk 11330-20
250 mm - 9¾"	tk 11330-25



TAYLOR			
175 mm - 7"	tk 11350-17	tk 11352-17	tk 11353-17



GERALD			
170 mm - 6¾"	tk 11356-17	tk 11357-17	
180 mm - 7"			tk 11359-18



CUSHING		
170 mm - 6¾"	tk 11400-17	tk 11401-17

Ohr- und Nasenpinzetten
Ear and nose dressing forceps

Pinces auriculaires et nasaux
Pinzas auriculares y nasales
Pinze auricolari e nasali

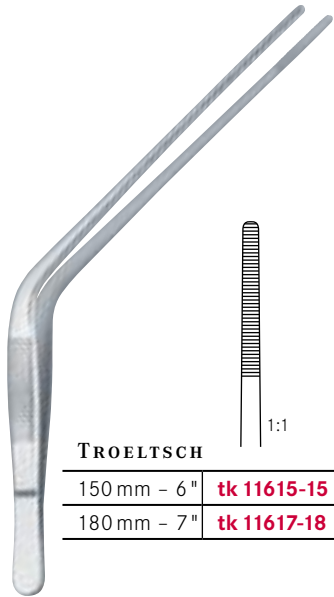

TROELTSCH

150 mm - 6 "	tk 11615-15
180 mm - 7 "	tk 11617-18

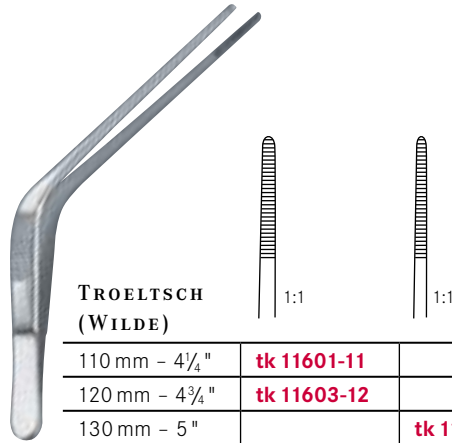

TROELTSCH
(WILDE)

110 mm - 4 1/4 "	tk 11601-11	
120 mm - 4 3/4 "	tk 11603-12	
130 mm - 5 "		tk 11608-13



LUCAE

140 mm - 5 1/2 "	tk 11605-14
------------------	--------------------

gekreuzt
cross action
croisé
cruzado
crociato



JANSEN

160 mm - 6 1/4 "	tk 11609-16
------------------	--------------------



JANSEN

160 mm - 6 1/4 "	tk 11607-16
200 mm - 8 "	tk 11607-20



COTTLE

145 mm - 5 3/4 "	tk 11629-14
------------------	--------------------



Columella Pinzette
Columella forceps
Pince à columella
Pinza para columella
Pinze per columella

Irispinzetten
Iris forceps

Pinces à iridectomie
Pinzas para Iris
Pinze per iridectomia

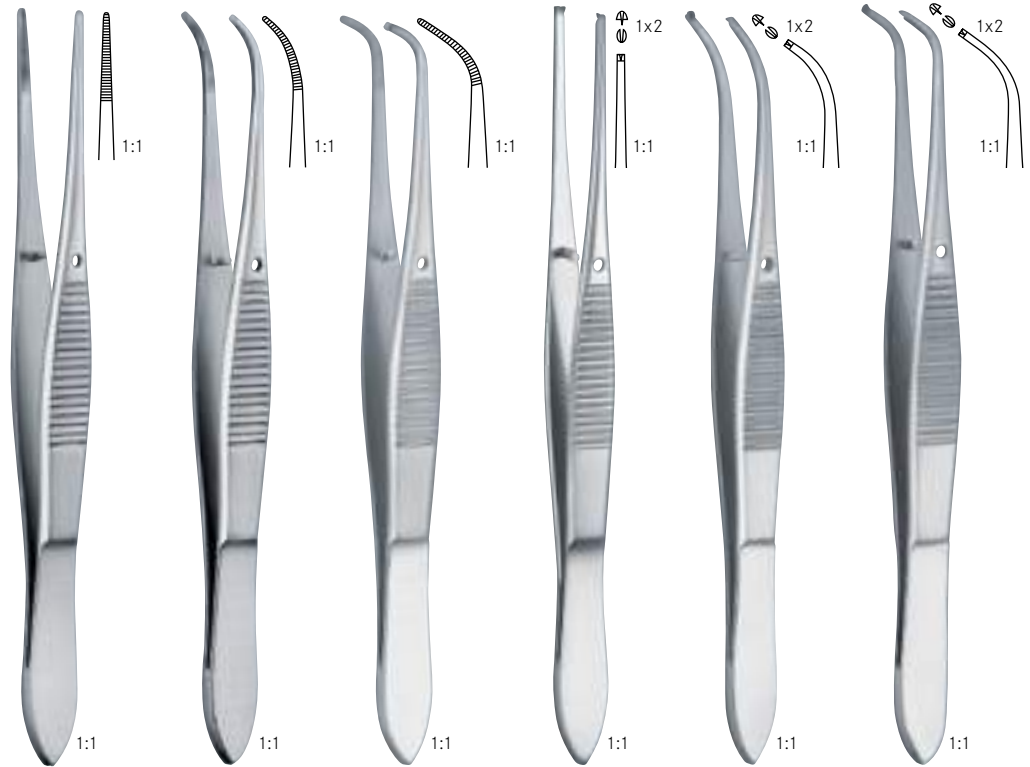

GRAEFE

105 mm - 4 1/4"	tk 11700-10	tk 11701-10	tk 11703-10	tk 11730-10	tk 11731-10	tk 11733-10
-----------------	-------------	-------------	-------------	-------------	-------------	-------------

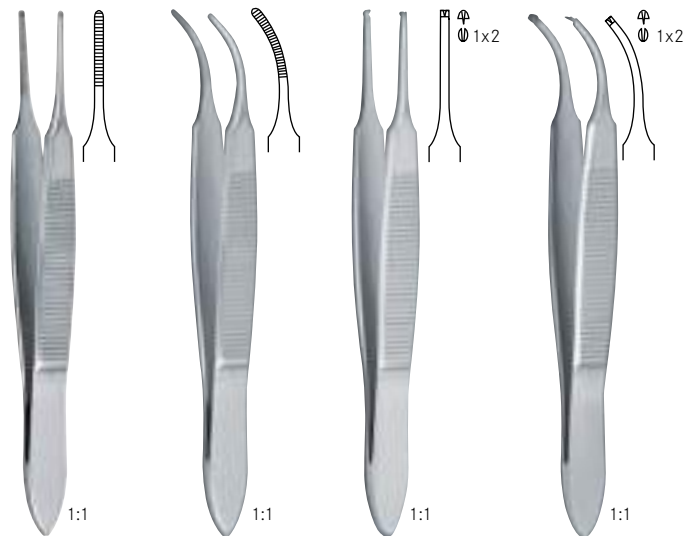

GRAEFE

	70 mm - 2 3/4"	70 mm - 2 3/4"	70 mm - 2 3/4"	70 mm - 2 3/4"
0.7 mm	tk 11750-07	tk 11751-07	tk 11780-07	tk 11781-07
1.0 mm	tk 11750-10	tk 11751-10	tk 11780-10	tk 11781-10

Feine Pinzetten
Forceps - fine patterns

Pinces - modèles fines
Pinzas - modelos finos
Pinze - modelli fini



90 mm - 3½"	tk 11740-09	tk 11741-09
105 mm - 4¼"	tk 11740-10	tk 11741-10
115 mm - 4½"	tk 11740-11	tk 11741-11
125 mm - 5"	tk 11740-12	tk 11741-12

glatt
smooth
lisse
lisa
liscio



90 mm - 3½"	tk 11742-09	tk 11743-09
105 mm - 4¼"	tk 11742-10	tk 11743-10
115 mm - 4½"	tk 11742-11	tk 11743-11
125 mm - 5"	tk 11742-12	tk 11743-12

gerieft
serrated
striée
estriada
zigrinato

Fasspinzetten | Pinces à saisir
 Grasping forceps | Pinzas para coger
 Pinze da presa



DURANTE

145 mm - 5 3/4"	tk 11910-14
160 mm - 6 1/4"	tk 11910-16
200 mm - 8"	tk 11910-20



RUSS. MODELL

150 mm - 6"	tk 11920-15
200 mm - 8"	tk 11920-20
250 mm - 9 3/4"	tk 11920-25
300 mm - 11 3/4"	tk 11920-30



MAYO-RUSS.

230 mm - 9"	tk 11915-23
-------------	--------------------



NELSON

230 mm - 9"	tk 11918-23
-------------	--------------------



SINGLEY-TUTTLE

180 mm - 7"	tk 11917-18
230 mm - 9"	tk 11917-23
350 mm - 14"	tk 11917-35



COLLIN-DUVAL

200 mm - 8"	tk 11927-01
x = 14 mm	

x = 18 mm	tk 11927-02
-----------	--------------------

x = 27 mm	tk 11927-03
-----------	--------------------

Atraumatische Pinzetten
Atraumatic tissue forceps

Pinces atraumatiques
Pinzas de disección atraumáticas
Pinze per dissezione atraumatiche

ATRAUMTK

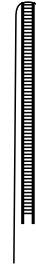
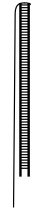
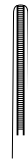
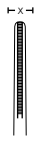

DE BAKEY

	x = 1.5 mm	x = 2.0 mm	x = 2.7 mm	x = 3.5 mm
120 mm - 4¾"	tk 11960-12			
145 mm - 5¾"	tk 11960-14	tk 11964-14		
160 mm - 6¼"	tk 11960-16	tk 11964-16	tk 11966-16	tk 11965-16
200 mm - 8"	tk 11960-20	tk 11964-20	tk 11966-20	tk 11965-20
240 mm - 9½"	tk 11960-24	tk 11964-24	tk 11966-24	tk 11965-24
300 mm - 12"	tk 11960-30	tk 11964-30	tk 11966-30	tk 11965-30
350 mm - 14"				tk 11965-35

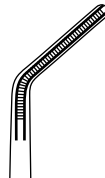
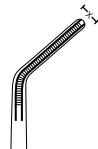

	x = 1.5 mm	x = 2.0 mm
145 mm - 5¾"	tk 11967-14	
160 mm - 6¼"		tk 11967-16
200 mm - 8"		tk 11967-20
240 mm - 9½"		tk 11967-24
300 mm - 12"		tk 11967-30

Atraumatische Pinzetten
Atraumatic tissue forceps

Pinces atraumatiques
Pinzas de disección atraumáticas
Pinze per dissezione atraumatiche



x

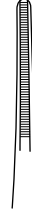
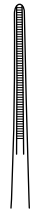
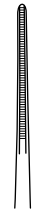

DE BAKEY

	x = 1.2 mm	x = 1.5 mm	x = 1.8 mm	x = 2.0 mm	x = 2.8 mm
160 mm - 6¼"	tk 11970-16	tk 11971-16	tk 11972-16	tk 11975-16	tk 11976-16
200 mm - 8"	tk 11970-20	tk 11971-20	tk 11972-20	tk 11975-20	tk 11976-20
240 mm - 9½"	tk 11970-24	tk 11971-24	tk 11972-24	tk 11975-24	tk 11976-24

Anatomische Pinzetten
Dressing forceps

Pinces à dissection
Pinzas de disección
Pinze anatomiche

TITANTK



STANDARD

145 mm - 5¾"	tk 10010-14	-
180 mm - 7"	tk 10010-18	tk 10011-18
250 mm - 10"	tk 10010-25	-

schmal
narrow
étroite
estrecha
stretta

Anatomische Pinzetten
Dressing forceps

Pinces à dissection
Pinzas de disección
Pinze anatomiche



SEMKEN

125 mm - 5"

tk 10302-12



1:2



1:2

TAYLOR

175 mm - 7"

tk 10304-17

tk 10305-17



1:2

GERALD

180 mm - 7"

tk 10306-18

Anatomische Pinzetten
Dressing forceps

Pincés à dissection
Pinzas de disección
Pinze anatomiche

TITANTK



ADSON

120 mm - 4¾" **tk 10520-12**

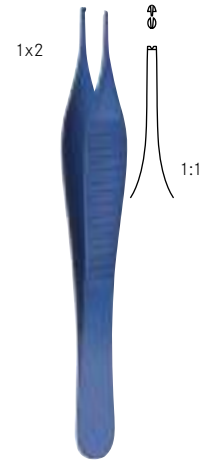

ADSON

120 mm - 4¾" **tk 11220-12**



MC INDOE

150 mm - 6"

tk 10560-15



POTTS-SMITH

180 mm - 7" **tk 10660-18**

210 mm - 8¼" **tk 10660-21**

250 mm - 9¾" **tk 10660-25**

Chirurgische Pinzetten
Tissue forceps

Pinces à dissection à griffes
Pinzas de disección con dientes
Pinze chirurgiche



GILLIES
150 mm - 6"
tk 11255-15

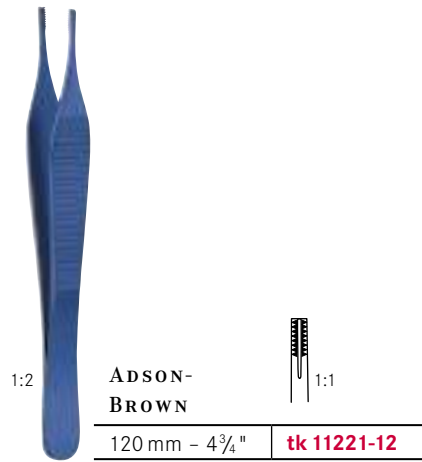

ADSON-BROWN
120 mm - 4 3/4" **tk 11221-12**



GERALD
170 mm - 6 3/4" **tk 11370-17**



TAYLOR
175 mm - 7" **tk 10305-17**

Anatomische Pinzetten
Dressing forceps

Pinces à dissection
Pinzas de disección
Pinze anatomiche

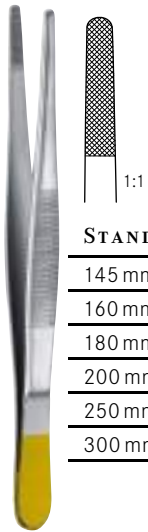

STANDARD

145 mm - 5 ³ / ₄ "	tk 11977-14
160 mm - 6 ¹ / ₄ "	tk 11977-16
180 mm - 7"	tk 11977-18
200 mm - 8"	tk 11977-20
250 mm - 9 ³ / ₄ "	tk 11977-25
300 mm - 12"	tk 11977-30



MC INDOE

150 mm - 6"	tk 11640-15
-------------	--------------------



POTTS-SMITH

150 mm - 6"	tk 11652-15
180 mm - 7"	tk 11652-18
210 mm - 8 ¹ / ₄ "	tk 11652-21
250 mm - 9 ³ / ₄ "	tk 11652-25

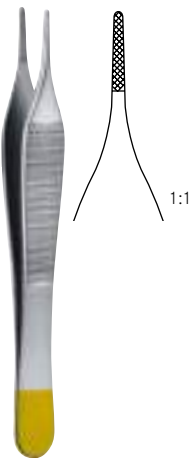

ADSON

120 mm - 4 ³ / ₄ "	tk 10502-12
150 mm - 6"	tk 10502-15



WANGENSTEEN

150 mm - 6"	tk 10610-15
230 mm - 9"	tk 10610-23



CUSHING

175 mm - 7"	tk 10402-17
-------------	--------------------



TAYLOR

180 mm - 7"	tk 10415-18
-------------	--------------------

Chirurgische Pinzetten
Tissue forceps

Pinces à dissection à griffes
Pinzas de disección con dientes
Pinze chirurgiche

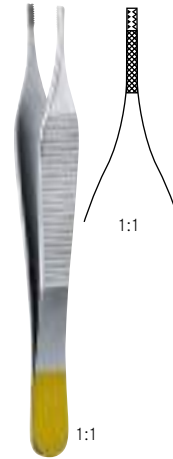
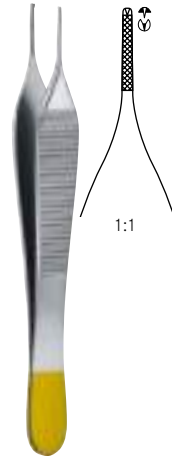

ADSON

120 mm - 4 3/4 "	tk 10504-12
150 mm - 6 "	tk 10504-15

ADSON-MICRO

tk 10506-12
tk 10506-15

ADSON-BROWN

tk 10508-12

GILLIES

150 mm - 6 "
tk 11638-15



1:2

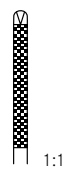

1:1



1:1



1:1

OEHLER

140 mm - 5 1/2 "	160 mm - 6 1/4 "	180 mm - 7 "
tk 11690-14	tk 11690-16	tk 11690-18



1:1

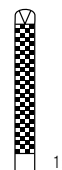

1:1

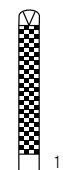

1:1

200 mm - 8 "	250 mm - 9 3/4 "	300 mm - 12 "
tk 11690-20	tk 11690-25	tk 11690-30

Atraumatische Pinzetten
Atraumatic tissue forceps

Pinces atraumatiques
Pinzas de disección atraumáticas
Pinze per dissezione atraumatiche

ATRAUMTK

TUCARK



DE BAKEY

	x = 1.5 mm	x = 2.0 mm
150 mm - 6"	tk 11968-15	tk 11969-15
190 mm - 7½"	tk 11968-19	tk 11969-19
240 mm - 9½"	tk 11968-24	tk 11969-24

Splitterpinzetten
Splinter forceps

Pinces à échardes
Pinzas para espinas
Pinze fini per schegge



FEILCHENFELD	
75 mm - 3"	tk 11500-08
90 mm - 3½"	tk 11500-09
115 mm - 4½"	tk 11500-11



HUNTER		
105 mm - 4¼"	tk 11520-10	tk 11521-10

Splitterpinzetten
Splinter forceps

Pinces à échardes
Pinzas para espinas
Pinze fini per schegge

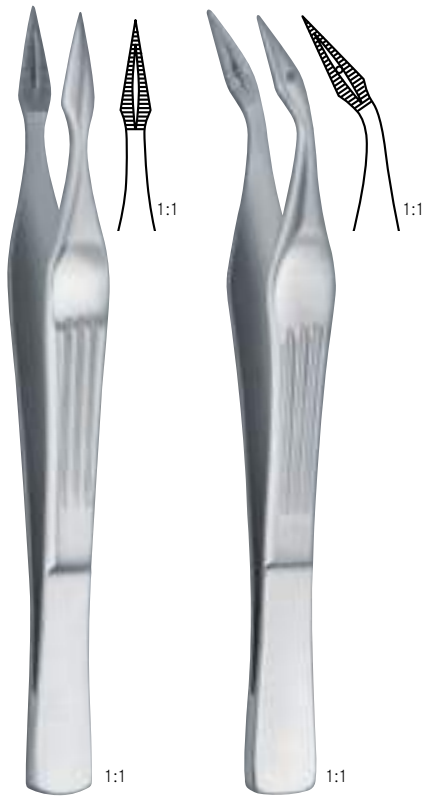

**WALTER-
CARMALT**

105 mm - 4 1/4"	tk 11530-10	tk 11531-10
-----------------	--------------------	--------------------



80 mm - 3 1/4"	tk 11533-12
----------------	--------------------



100 mm - 4"	tk 11540-10
125 mm - 5"	tk 11540-12

Zilienpinzetten
Cilia forceps

Pinces à épiler
Pinzas depilatorias
Pinze per depilazione



BEER

90 mm - 3 1/2"

tk 11834-09



DOUGLAS

90 mm - 3 1/2"

tk 11836-09

tk 11838-09



LITTAUER

85 mm - 3 1/4"

tk 11840-09

90 mm - 3 1/2"

tk 11841-09



GRADLE

95 mm - 3 3/4"

tk 11846-09



BARRAQUER

105 mm - 4 1/4"

tk 11860-10



Arterienklemmen
Haemostatic forceps

Pinces hémostatiques
Pinzas hemostáticas
Pinze emostatiche

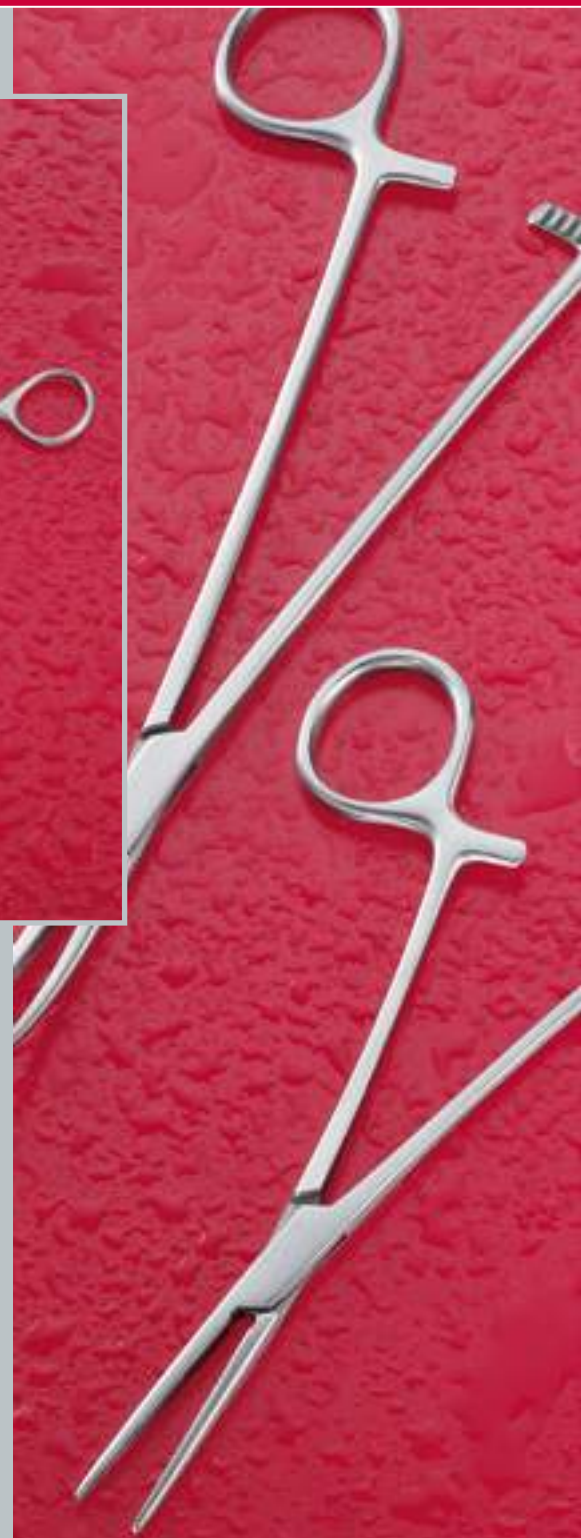

Gefäßklemmen
Haemostatic forceps

Serre-fines
Serrafinas
Serrafine



DIEFFENBACH		
35 mm - 1 1/2"	tk 11930-03	tk 11931-03
50 mm - 2"	tk 11930-05	tk 11931-05
60 mm - 2 1/4"	tk 11930-06	tk 11931-06



JOHNS HOPKINS	
50 mm - 2"	tk 11935-05
65 mm - 2 1/2"	tk 11935-06
75 mm - 3"	tk 11935-07



DIETRICH

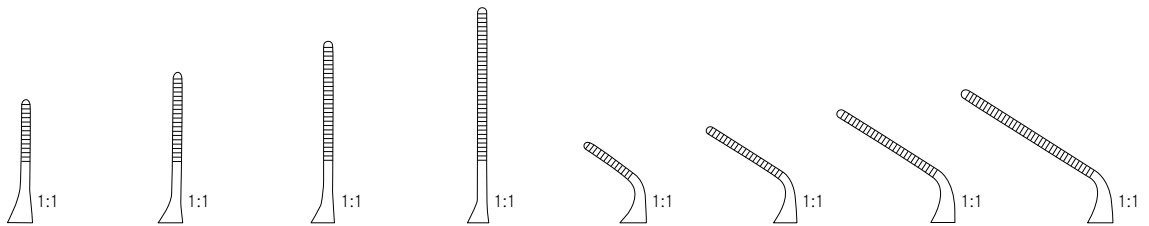

x =	50 mm - 2"	50 mm - 2"	50 mm - 2"	60 mm - 2 1/4"	50 mm - 2"	50 mm - 2"	50 mm - 2"	60 mm - 2 1/4"
y =	8 mm	12 mm	16 mm	20 mm	8 mm	12 mm	16 mm	20 mm
	tk 11940-08	tk 11940-12	tk 11940-16	tk 11940-20	tk 11941-08	tk 11941-12	tk 11941-16	tk 11941-20

x = Länge
Length
Longueur
Longitud
Lunghezza

y = geriefte Maullänge
serated jaw part
partie striée du mors
parte estriada de la boca
morso zigrinato



Atraumatische Klemmen sind abgebildet von Seite 489 bis 434
Atraumatic forceps, please see the pages 489 to 434

Pinces atraumatiques, voire pages 489 à 434
Pinzas atraumáticas, ver paginas 489 a 434
Pinze atraumatiche, vedete pagina 489 a 434

Arterienklemmen
Haemostatic forceps

Pinces hémostatiques
Pinzas hemostáticas
Pinze emostatiche

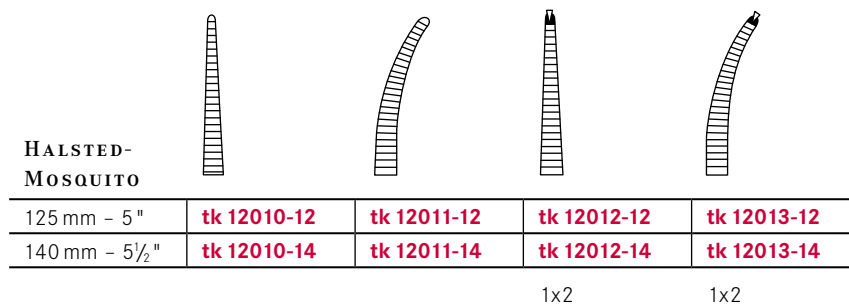
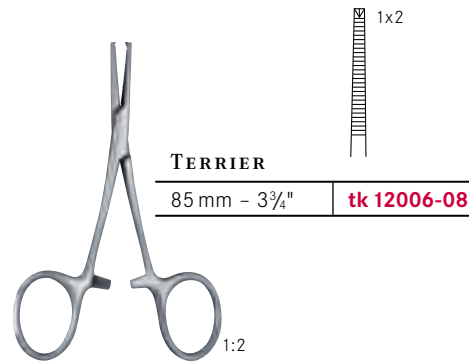
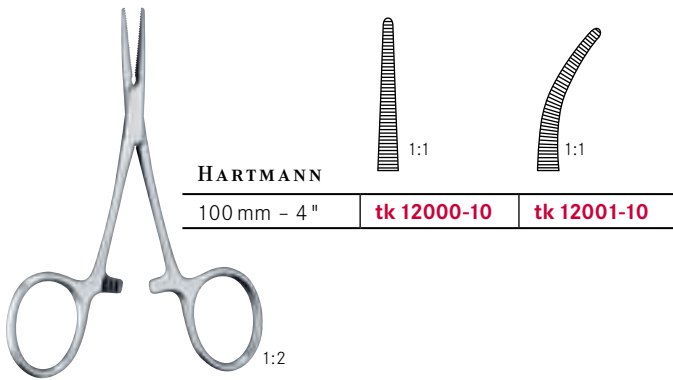

TITANK

Arterienklemmen
Haemostatic forceps

Pinces hémostatiques
Pinzas hemostáticas
Pinze emostatiche



MICRO-MOSQUITO

100 mm - 4"	tk 12020-10	tk 12021-10	tk 12022-10	tk 12023-10
120 mm - 4 3/4"	tk 12020-12	tk 12021-12	tk 12022-12	tk 12023-12

1x2

1x2

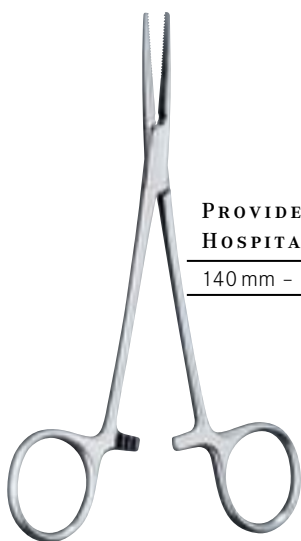

PROVIDENCE-HOSPITAL

140 mm - 5 1/2"	tk 12020-14	tk 12021-14
-----------------	-------------	-------------

1:2



DANDY

140 mm - 5 1/2"	tk 12030-14	tk 12032-14
-----------------	-------------	-------------

seitlich gebogen
curved to the side
courbe sur le plat
curva al lado
curvata lateralmente

1x2

1:2



MOSQUITO-DANDY

120 mm - 4 3/4"	tk 12031-12
-----------------	-------------

seitlich gebogen
curved to the side
courbe sur le plat
curva al lado
curvata lateralmente

1:2

Arterienklemmen
Haemostatic forceps

Pinces hémostatiques
Pinzas hemostáticas
Pinze emostatiche

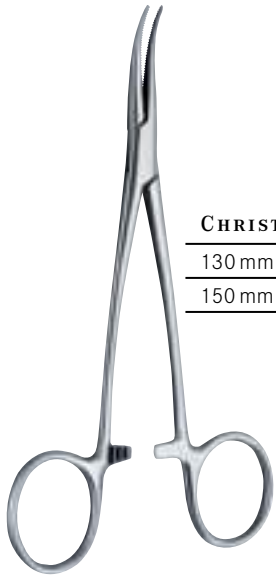

CHRISTOPHE

130 mm – 4 "	tk 12039-13
150 mm – 6 "	tk 12039-15

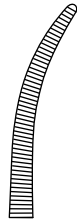

LOVELACE

155 mm – 6 "	tk 12195-15	tk 12196-15
--------------	--------------------	--------------------

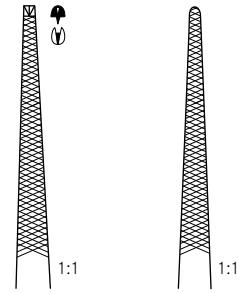

1x2



LERICHE

150 mm – 6 "	tk 12034-15	tk 12035-15
--------------	--------------------	--------------------

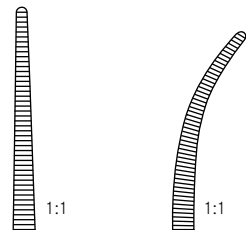

LERICHE

150 mm – 6 "	tk 12036-15	tk 12037-15
--------------	--------------------	--------------------

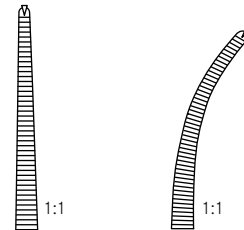

1x2

1x2

Arterienklemmen
Haemostatic forceps

Pinces hémostatiques
Pinzas hemostáticas
Pinze emostatiche

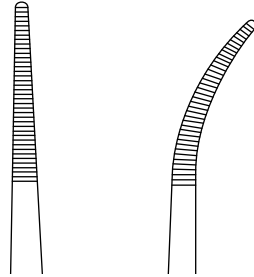

KELLY

140 mm - 5 1/2"	tk 12040-14	tk 12041-14
-----------------	-------------	-------------

KELLY-RANKIN

160 mm - 6 1/4"	tk 12040-16	tk 12041-16
-----------------	-------------	-------------

KELLY

140 mm - 5 1/2"	tk 12140-14	tk 12141-14
-----------------	-------------	-------------

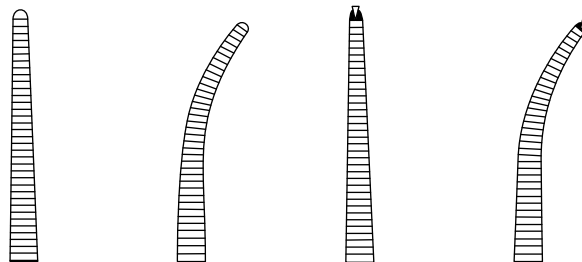

CRILE

140 mm - 5 1/2"	tk 12050-14	tk 12051-14	tk 12052-14	tk 12053-14
			1x2	1x2

CRILE-RANKIN

160 mm - 6 1/4"	tk 12050-16	tk 12051-16	tk 12054-16	tk 12055-16
			1x2	1x2

CRILE

140 mm - 5 1/2"	tk 12250-14	tk 12251-14
-----------------	-------------	-------------



Arterienklemmen
Haemostatic forceps
Pinces hémostatiques
Pinzas hemostáticas
Pinze emostatiche

COLLER

140 mm – 5½"	tk 12056-14	tk 12057-14
160 mm – 6¼"	tk 12056-16	tk 12057-16

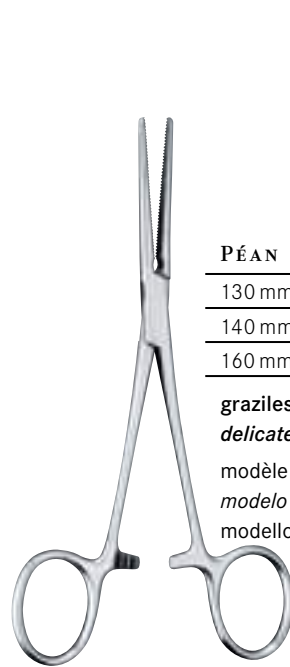
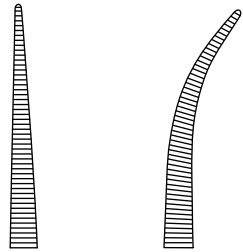
PÉAN

130 mm – 5"	tk 12058-13	tk 12059-13
140 mm – 5½"	tk 12058-14	tk 12059-14
160 mm – 6¼"	tk 12058-16	tk 12059-16

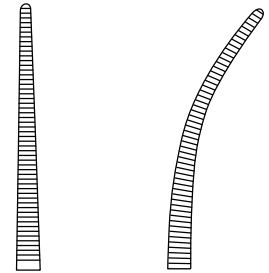

graziles Modell
delicate pattern
 modèle délicat
 modelo delicado
 modello delicato

DUNHILL

125 mm – 5"	tk 12268-12
-------------	--------------------

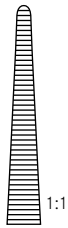

1:1

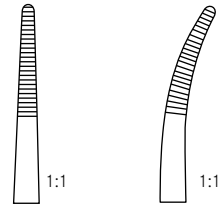

CAIRNS

150 mm – 6"	tk 12269-01	tk 12269-02
-------------	--------------------	--------------------

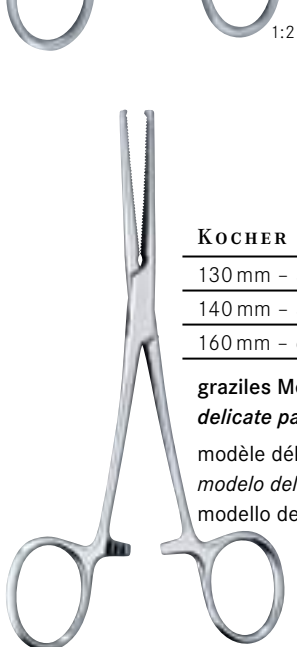

1:1

1:1

KOCHER

130 mm – 5"	tk 12078-13	tk 12079-13
140 mm – 5½"	tk 12078-14	tk 12079-14
160 mm – 6¼"	tk 12078-16	tk 12079-16

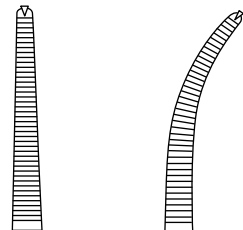

1x2

1x2

graziles Modell
delicate pattern
 modèle délicat
 modelo delicado
 modello delicato

Arterienklemmen
Haemostatic forceps

Pinces hémostatiques
Pinzas hemostáticas
Pinze emostatiche



PÉAN-FINO

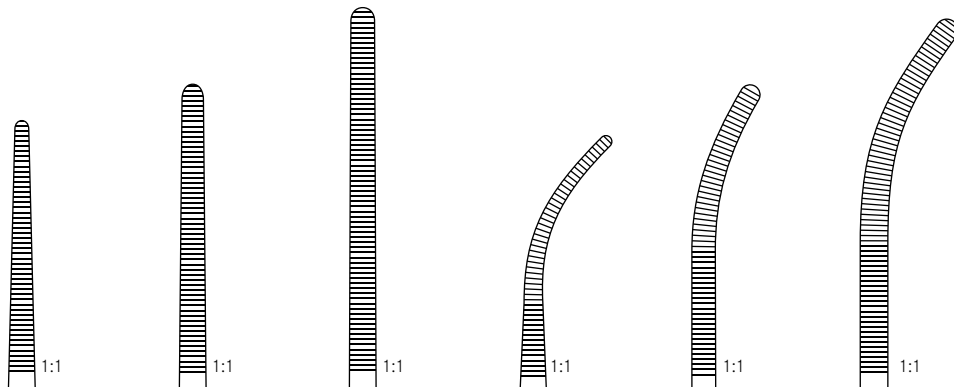

145 mm - 5 3/4"	165 mm - 6 1/2"	185 mm - 7 1/4"	140 mm - 5 1/2"	160 mm - 6 1/4"	180 mm - 7"
tk 12062-14	tk 12062-16	tk 12062-18	tk 12063-14	tk 12063-16	tk 12063-18



KOCHER-FINO

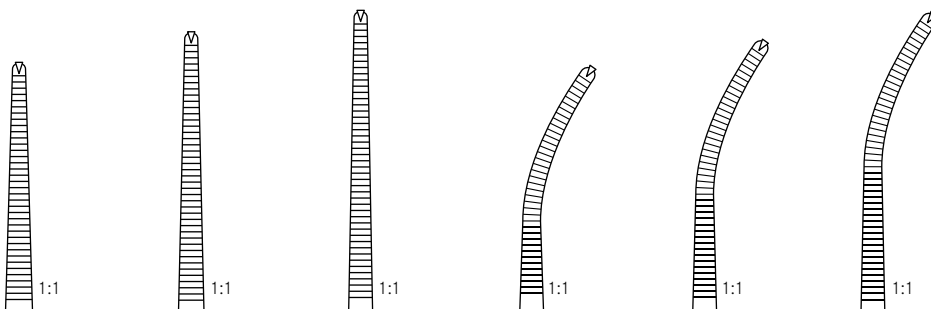

145 mm - 5 3/4"	165 mm - 6 1/2"	185 mm - 7 1/4"	145 mm - 5 3/4"	160 mm - 6 1/4"	180 mm - 7"
tk 12082-14	tk 12082-16	tk 12082-18	tk 12083-14	tk 12083-16	tk 12083-18
1x2	1x2	1x2	1x2	1x2	1x2

Arterienklemmen
Haemostatic forceps

Pinces hémostatiques
Pinzas hemostáticas
Pinze emostatiche



ROCHESTER-
PÉAN

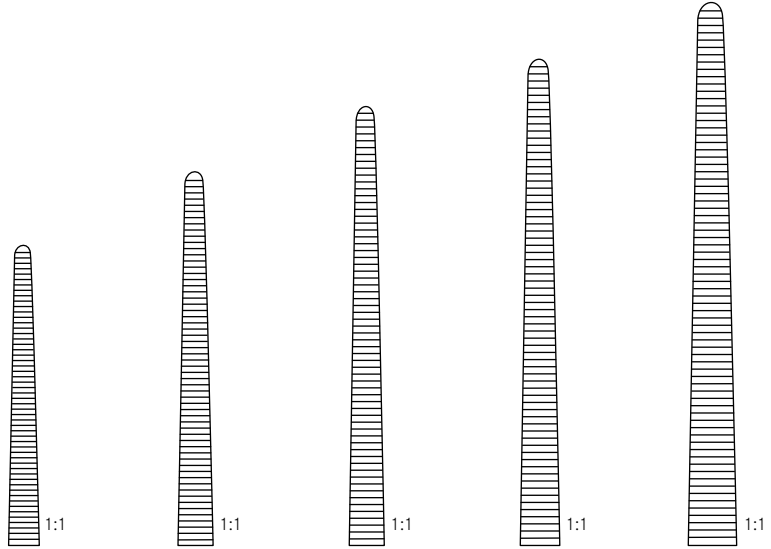

140 mm – 5½"	160 mm – 6¼"	180 mm – 7"	200 mm – 8"	220 mm – 8¾"
tk 12060-14	tk 12060-16	tk 12060-18	tk 12060-20	tk 12060-22

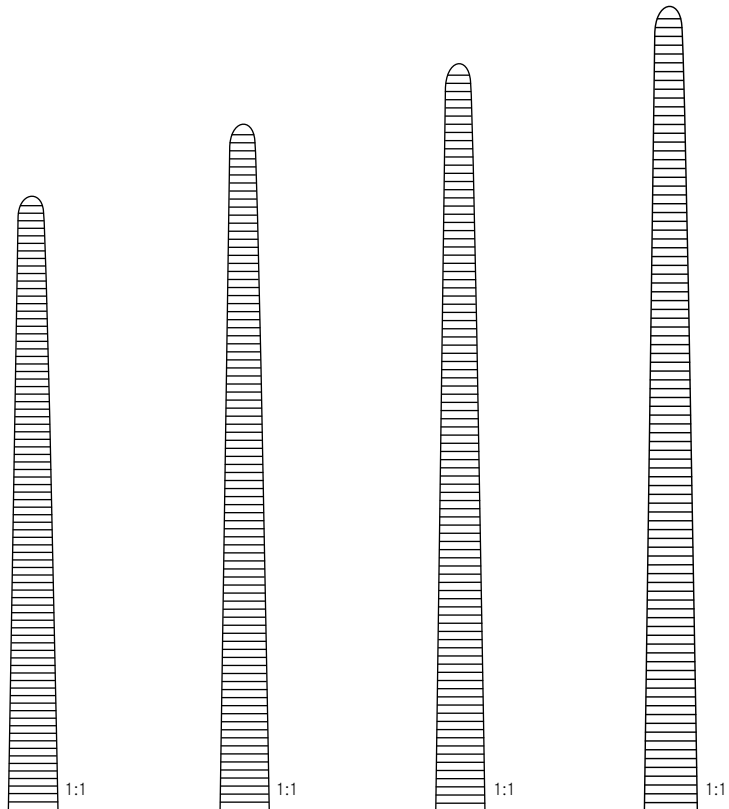

240 mm – 9½"	260 mm – 10¼"	300 mm – 12"	350 mm – 14"
tk 12060-24	tk 12060-26	tk 12060-30	tk 12060-35

Arterienklemmen
Haemostatic forceps

Pinces hémostatiques
Pinzas hemostáticas
Pinze emostatiche

ROCHESTER-PÉAN

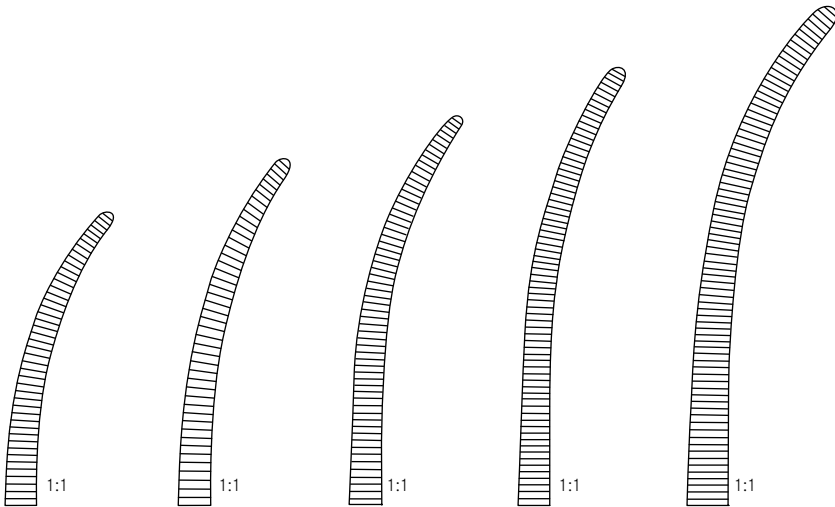

140 mm - 5½"	160 mm - 6¼"	180 mm - 7"	200 mm - 8"	220 mm - 8¾"
tk 12061-14	tk 12061-16	tk 12061-18	tk 12061-20	tk 12061-22

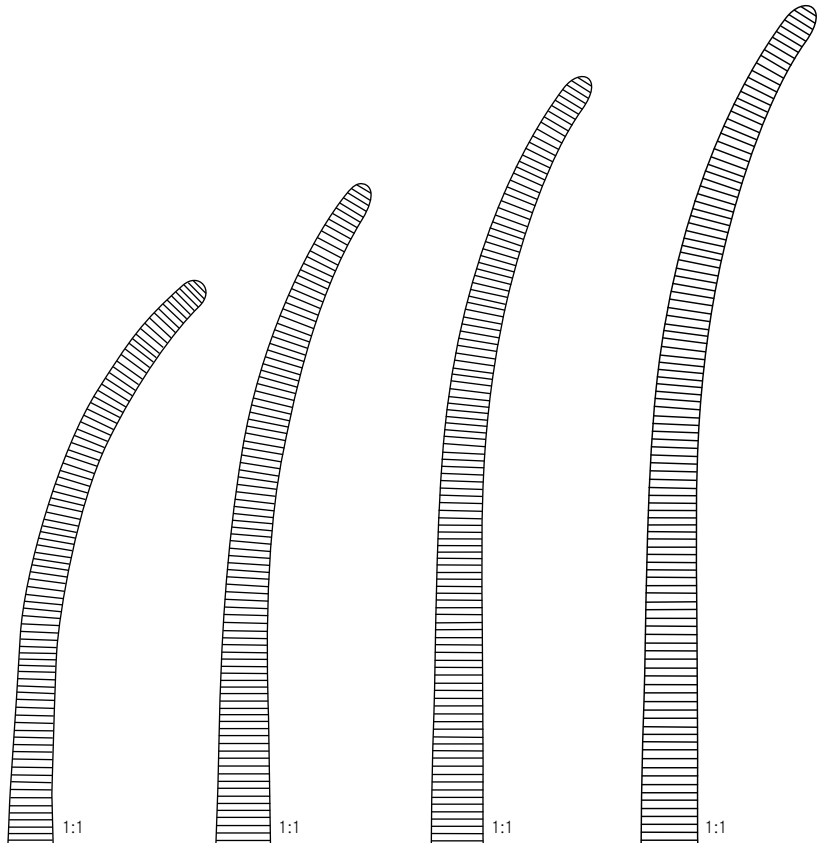

240 mm - 9½"	260 mm - 10¼"	300 mm - 12"	350 mm - 14"
tk 12061-24	tk 12061-26	tk 12061-30	tk 12061-35

Arterienklemmen
Haemostatic forceps

Pinces hémostatiques
Pinzas hemostáticas
Pinze emostatiche



OCHSNER-
KOCHER

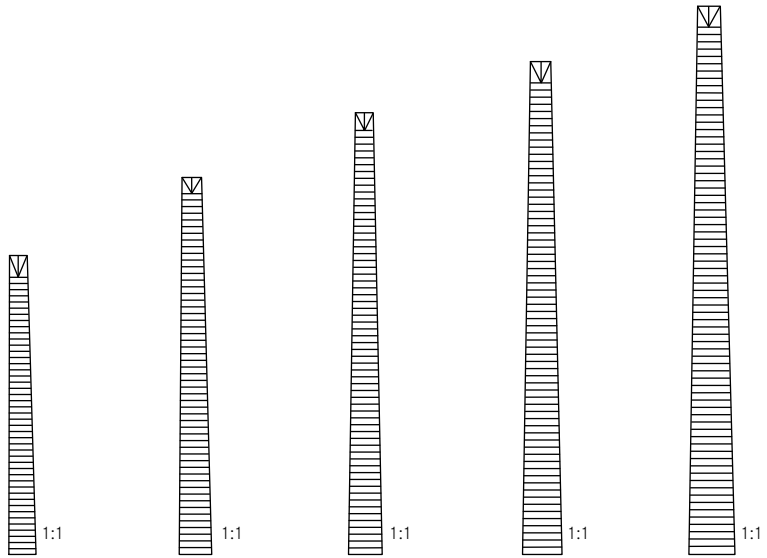

140 mm – 5½"	160 mm – 6¼"	180 mm – 7"	200 mm – 8"	220 mm – 8¾"
tk 12080-14	tk 12080-16	tk 12080-18	tk 12080-20	tk 12080-22
1x2	1x2	1x2	1x2	1x2

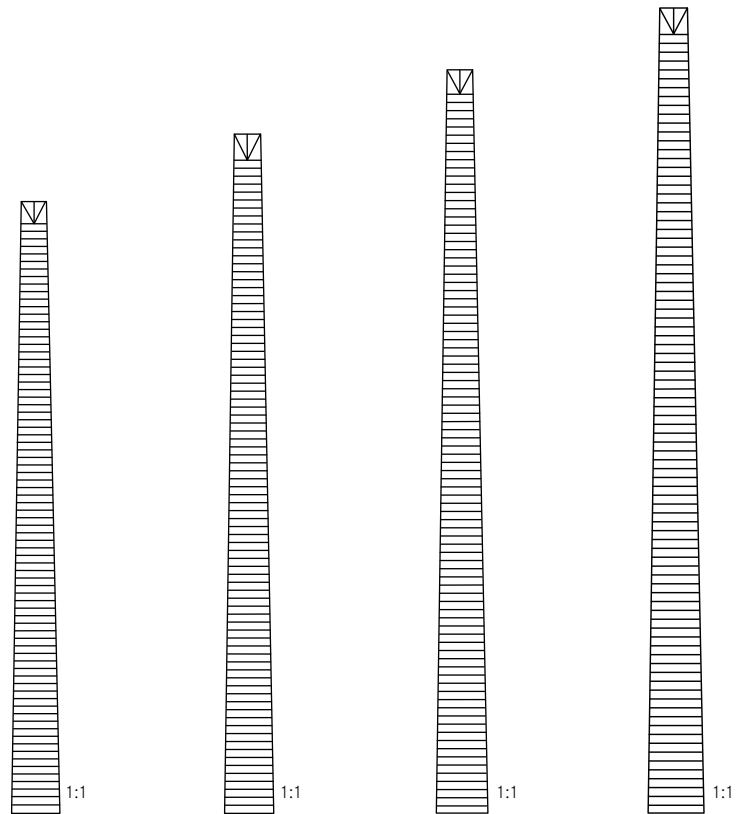

240 mm – 9½"	260 mm – 10¼"	300 mm – 12"	350 mm – 14"
tk 12080-24	tk 12080-26	tk 12080-30	tk 12080-35
1x2	1x2	1x2	1x2

Arterienklemmen
Haemostatic forceps

Pinces hémostatiques
Pinzas hemostáticas
Pinze emostatiche

OCHSNER-KOCHER

140 mm - 5½"	160 mm - 6¼"	180 mm - 7"	200 mm - 8"	220 mm - 8¾"
tk 12081-14	tk 12081-16	tk 12081-18	tk 12081-20	tk 12081-22
1x2	1x2	1x2	1x2	1x2

240 mm - 9½"	260 mm - 10¼"	300 mm - 12"	350 mm - 14"
tk 12081-24	tk 12081-26	tk 12081-30	tk 12081-35
1x2	1x2	1x2	1x2

Arterienklemmen
Haemostatic forceps

Pinces hémostatiques
Pinzas hemostáticas
Pinze emostatiche



BIRKET

190 mm – 7½"

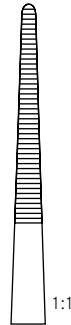

1:1

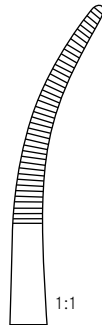

1:1

tk 12094-19	tk 12095-19
--------------------	--------------------



BAINBRIDGE

150 mm – 6"

185 mm – 7¼"

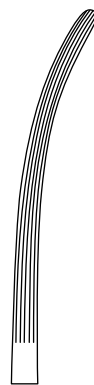

tk 12120-15	tk 12121-15
tk 12120-18	tk 12121-18

Arterienklemmen
Haemostatic forceps

Pinces hémostatiques
Pinzas hemostáticas
Pinze emostatiche

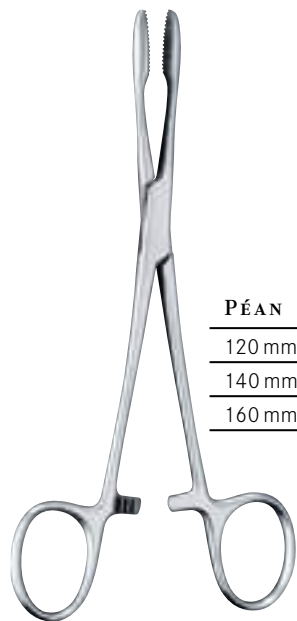

PÉAN

120 mm - 4 ³ / ₄ "	tk 12150-12
140 mm - 5 ¹ / ₂ "	tk 12150-14
160 mm - 6 ¹ / ₄ "	tk 12150-16



ROCHESTER-CARMALT

160 mm - 6 ¹ / ₄ "	tk 12170-16	tk 12171-16
200 mm - 8"	tk 12170-20	tk 12171-20

Arterienklemmen
Haemostatic forceps

Pinces hémostatiques
Pinzas hemostáticas
Pinze emostatiche



CHAPUT

130 mm – 5"

tk 12156-13



TUFFIER

130 mm – 5"

tk 12158-13

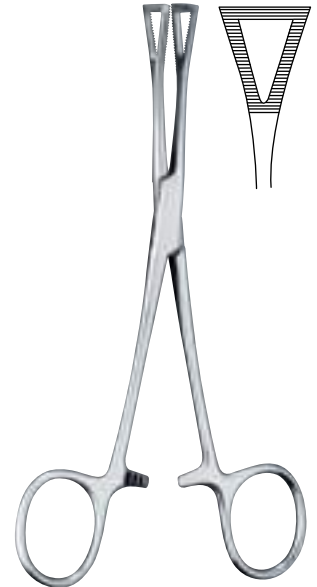

PENNINGTON

155 mm – 6"

tk 12160-15

200 mm – 8"

tk 12160-20



COLLIN

140 mm – 5½"

tk 12162-14



PRATT

150 mm – 6"

tk 12172-15



MARTEL

140 mm – 5½"

tk 12174-14

Arterienklemmen
Haemostatic forceps

Pinces hémostatiques
Pinzas hemostáticas
Pinze emostatiche

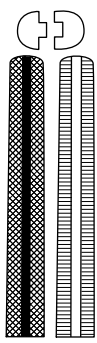

FERGUSSON	
160 mm - 6 1/4"	tk 12180-16
200 mm - 8"	tk 12180-20

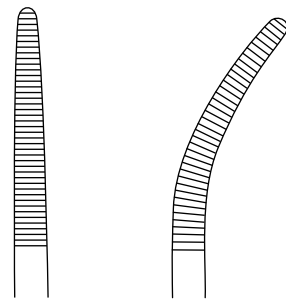
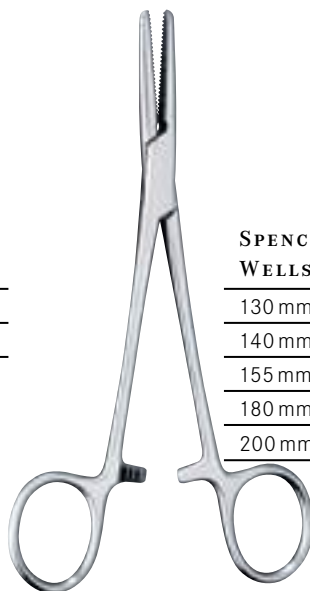

SPENCER-WELLS		
130 mm - 5"	tk 12190-13	tk 12191-13
140 mm - 5 1/2"	tk 12190-14	tk 12191-14
155 mm - 6"	tk 12190-15	tk 12191-15
180 mm - 7"	tk 12190-18	tk 12191-18
200 mm - 8"	tk 12190-20	tk 12191-20

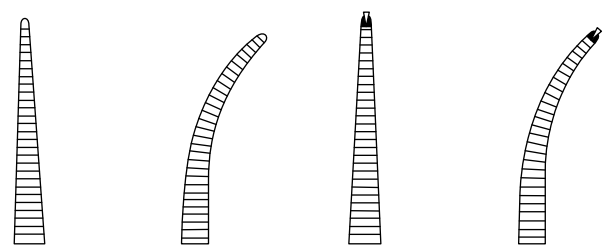

HALSTED-MOSQUITO				
180 mm - 7"	tk 12200-18	tk 12201-18	tk 12202-18	tk 12203-18
210 mm - 8 1/4"	tk 12200-21	tk 12201-21	tk 12202-21	tk 12203-21

1x2 1x2

Arterienklemmen
Haemostatic forceps

Pinces hémostatiques
Pinzas hemostáticas
Pinze emostatiche

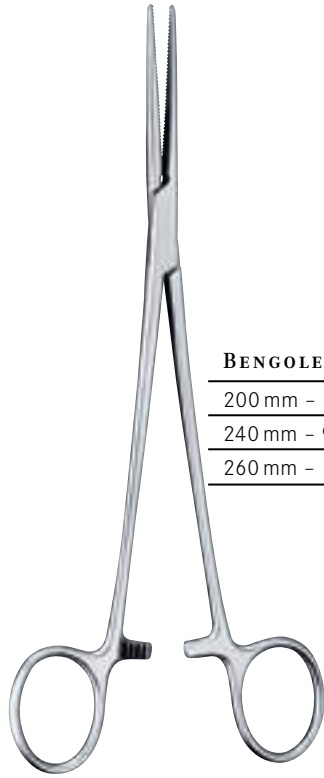

BENGOLEA

200 mm – 8"	tk 12205-20	tk 12206-20	tk 12207-20	tk 12208-20
240 mm – 9 1/2"	tk 12205-24	tk 12206-24	tk 12207-24	tk 12208-24
260 mm – 10 1/4"	tk 12205-26	tk 12206-26	tk 12207-26	tk 12208-26

1x2

1x2

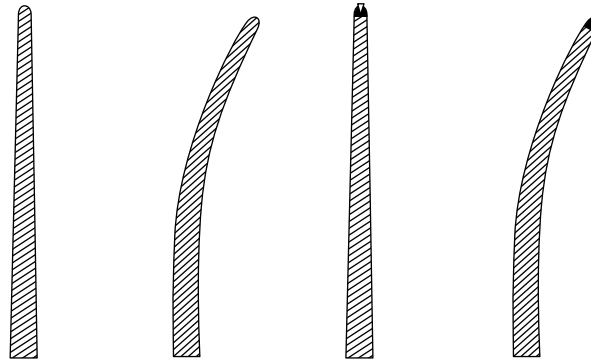

ADSON

185 mm – 7 1/4"	tk 12210-18	tk 12211-18	tk 12212-18	tk 12213-18
-----------------	-------------	-------------	-------------	-------------

1x2

1x2

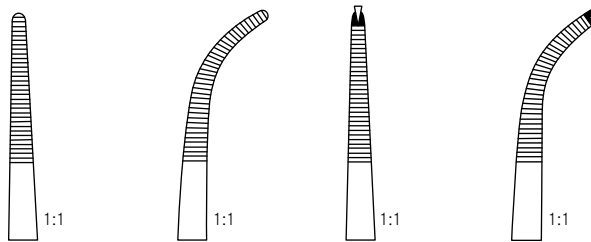

1:2

Arterienklemmen
Haemostatic forceps

Pinces hémostatiques
Pinzas hemostáticas
Pinze emostatiche

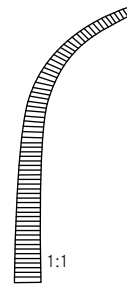
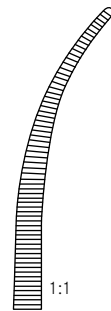
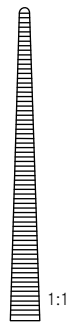

HEISS

200 mm - 8"

tk 12230-20

tk 12231-20

tk 12233-20

Arterienklemmen
Haemostatic forceps

Pinces hémostatiques
Pinzas hemostáticas
Pinze emostatiche



BABY-MIXTER

140 mm - 5½"	tk 12220-14	
180 mm - 7"		tk 12220-18

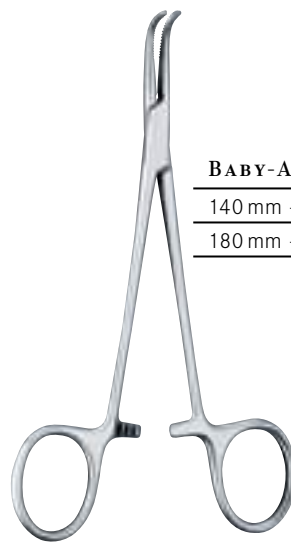
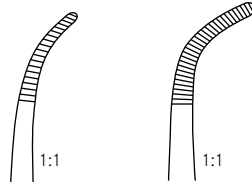

BABY-ADSON

140 mm - 5½"	tk 12221-14	
180 mm - 7"		tk 12221-18

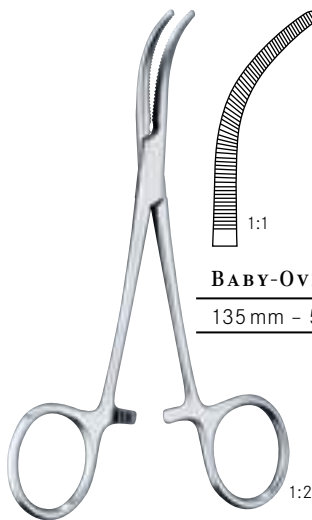
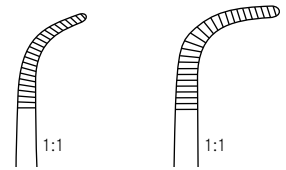

BABY-OVERHOLT

135 mm - 5¼"	tk 12287-14
--------------	--------------------

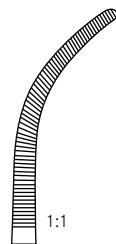

1:2

Arterienklemmen
Haemostatic forceps

Pinces hémostatiques
Pinzas hemostáticas
Pinze emostatiche

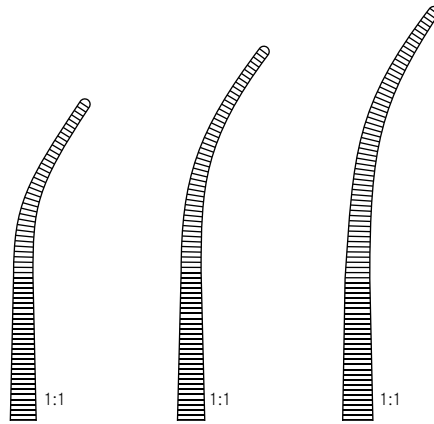

KELLY-FRASER		
Fig. 1	Fig. 1	Fig. 1
195 mm - 7 3/4"	225 mm - 8 3/4"	245 mm - 9 3/4"
tk 12223-19	tk 12223-22	tk 12223-24

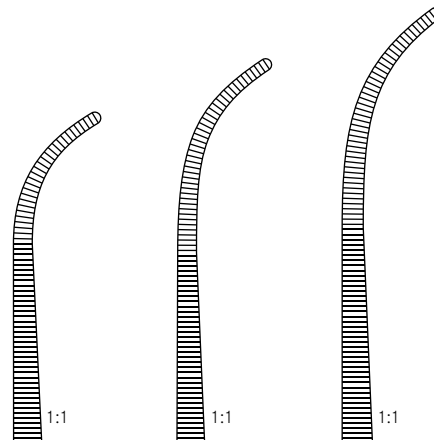

Fig. 2	Fig. 2	Fig. 2
190 mm - 7 1/2"	220 mm - 8 3/4"	240 mm - 9 1/2"
tk 12225-19	tk 12225-22	tk 12225-24

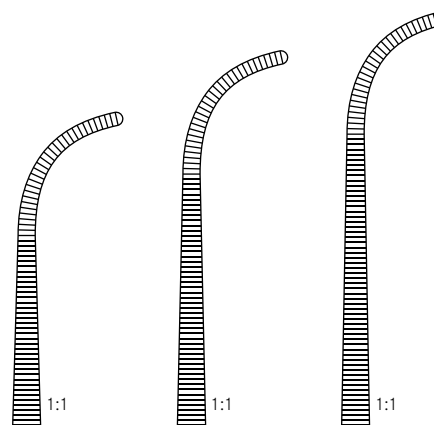

Fig. 3	Fig. 3	Fig. 3
185 mm - 7 1/4"	215 mm - 8 1/2"	235 mm - 9 1/4"
tk 12227-19	tk 12227-22	tk 12227-24

Arterienklemmen
Haemostatic forceps

Pinces hémostatiques
Pinzas hemostáticas
Pinze emostatiche



SCHNIDT

190 mm – 7½"

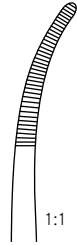

1:1

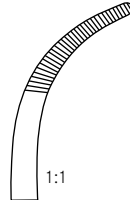

1:1

tk 12241-19

tk 12243-19



NISSEN

190 mm – 7½"

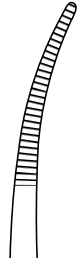

tk 12209-18



TOENNIS

210 mm – 8¼"

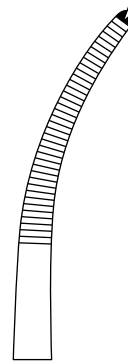
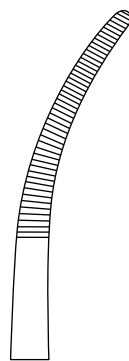
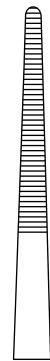

260 mm – 10¼"

tk 12250-21

tk 12251-21

tk 12252-21

tk 12253-21

tk 12250-26

tk 12251-26

tk 12252-26

tk 12253-26

1x2

1x2

Arterienklemmen
Haemostatic forceps

Pinces hémostatiques
Pinzas hemostáticas
Pinze emostatiche

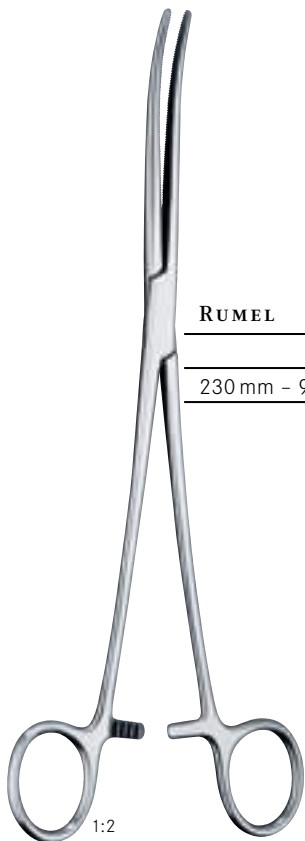

RUMEL

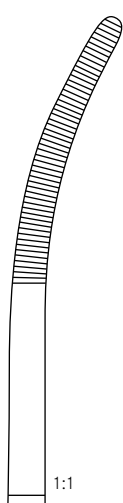

Fig. 1

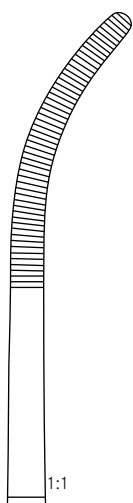

Fig. 2

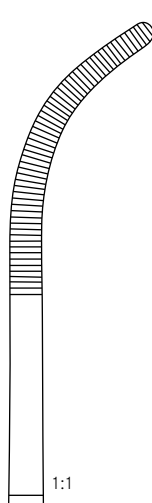

Fig. 3

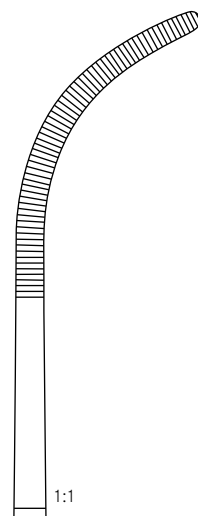

Fig. 4

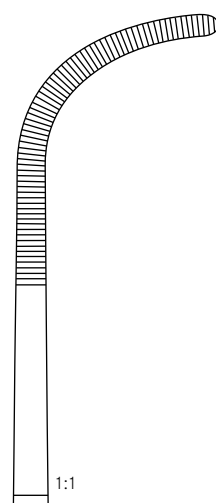
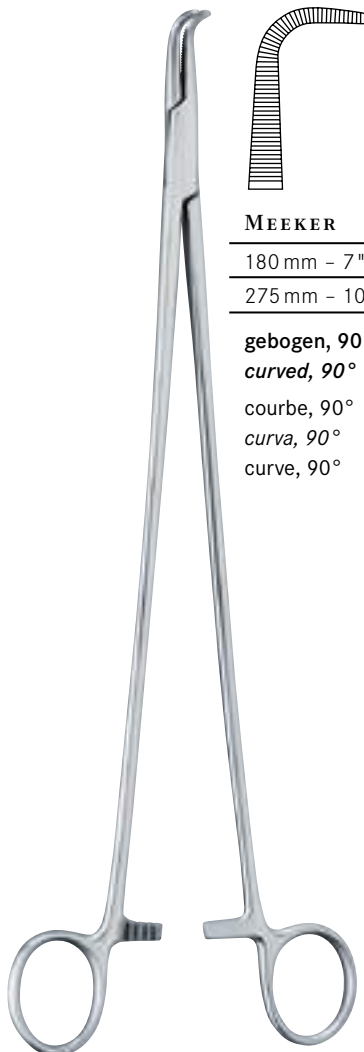

Fig. 5

	Fig. 1	Fig. 2	Fig. 3	Fig. 4	Fig. 5
230 mm - 9"	tk 12261-23	tk 12262-23	tk 12263-23	tk 12264-23	tk 12265-23



MEEKER

180 mm - 7"	tk 12091-18
275 mm - 10 ³ / ₄ "	tk 12091-27

gebogen, 90°
curved, 90°
courbe, 90°
curva, 90°
curve, 90°



LAWRENCE

280 mm - 11"	tk 12093-28
--------------	--------------------

Präparier- und Ligaturklemmen
Dissecting and ligature forceps

Pinces à disséquer et à sutures
Pinzas para preparación y suturas
Pinze per preparazioni e suture



OVERHOLT-
GEISSENDOERFER

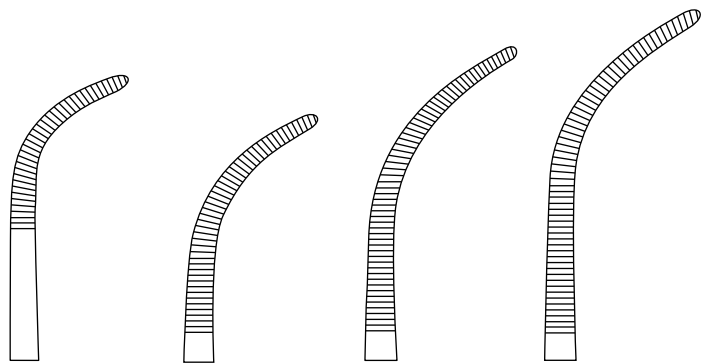

	Fig. 0	Fig. 1	Fig. 2	Fig. 3
210 mm - 8 1/4"	tk 12280-21	tk 12281-21	tk 12282-21	tk 12283-21
270 mm - 10 3/4"	tk 12280-27	tk 12281-27	tk 12282-27	tk 12283-27

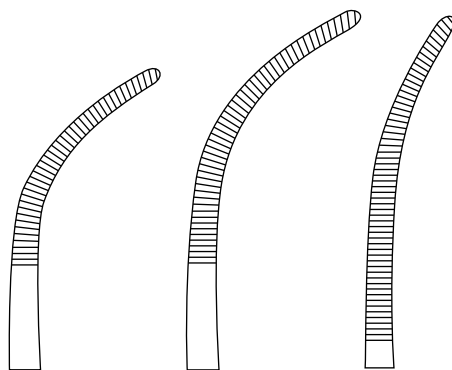

	Fig. 4	Fig. 5	Fig. 6
210 mm - 8 1/4"	tk 12284-21	tk 12285-21	tk 12286-21
270 mm - 10 3/4"	tk 12284-27	tk 12285-27	tk 12286-27

Präparier- und Ligaturklemmen
Dissecting and ligature forceps

Pinces à disséquer et à sutures
Pinzas para preparación y suturas
Pinze per preparazioni e suture



OVERHOLT-FINO

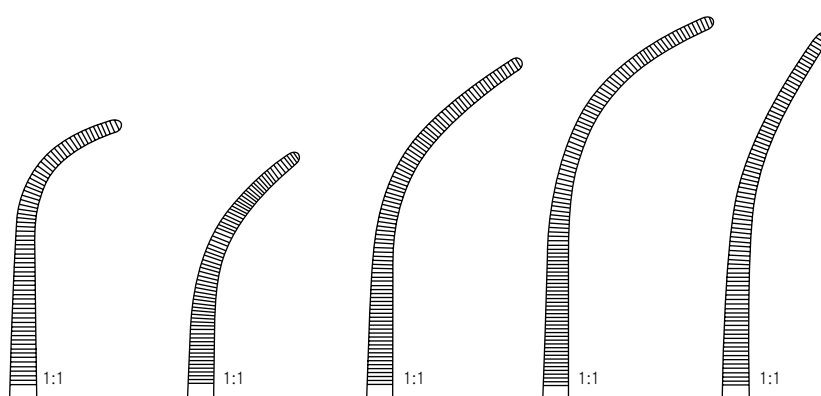

Fig. 0	Fig. 1	Fig. 2	Fig. 3	Fig. 6
215 mm - 8 1/2"	210 mm - 8 1/4"	220 mm - 8 3/4"	230 mm - 9"	225 mm - 8 3/4"
tk 12287-00	tk 12287-01	tk 12287-02	tk 12287-03	tk 12287-06



OVERHOLT

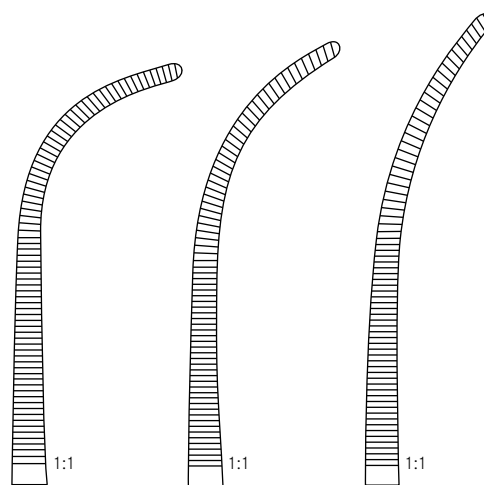
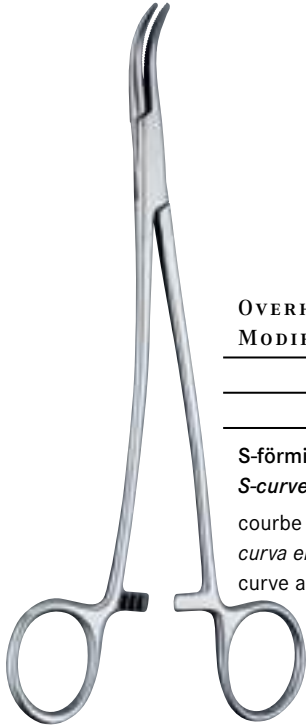

Fig. 0	Fig. 1	Fig. 6
295 mm - 8 1/2"	295 mm - 8 1/2"	300 mm - 8 3/4"
tk 12288-00	tk 12288-01	tk 12288-06

Präparier- und Ligaturklemmen
Dissecting and ligature forceps

Pinces à disséquer et à sutures
Pinzas para preparación y suturas
Pinze per preparazioni e suture



OVERHOLT-
MODIFIZIERT

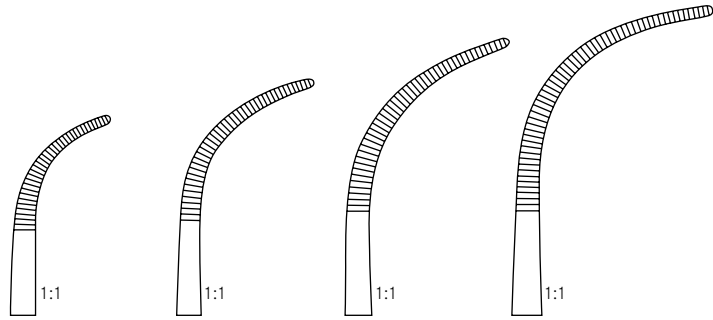

185 mm – 7 1/4"	205 mm – 8"	210 mm – 8 1/4"	215 mm – 8 1/2"
tk 12235-01	tk 12235-02	tk 12235-03	tk 12235-04

S-förmig gebogen
S-curved
courbe en S
curva en S
curve a forma di S

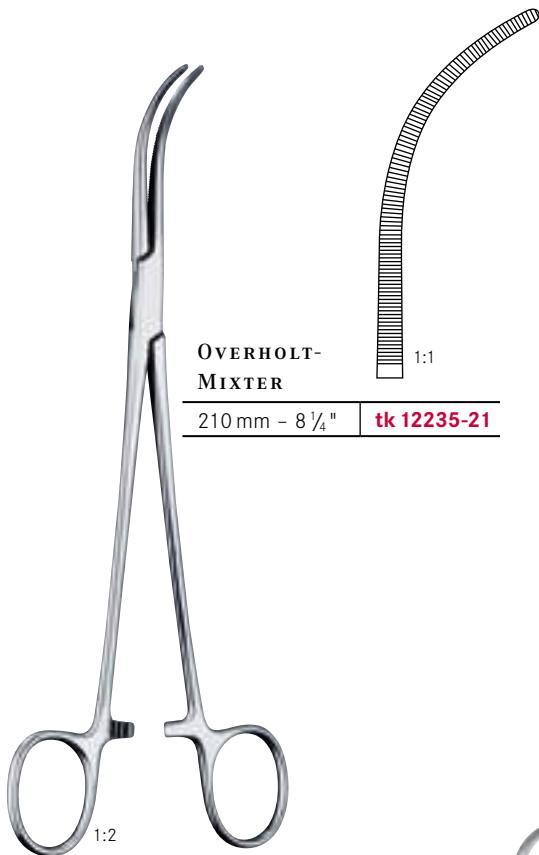

OVERHOLT-
MIXTER

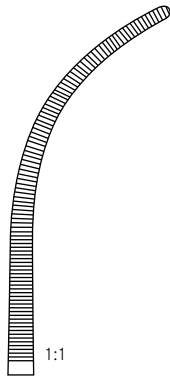

210 mm – 8 1/4"	tk 12235-21
-----------------	--------------------

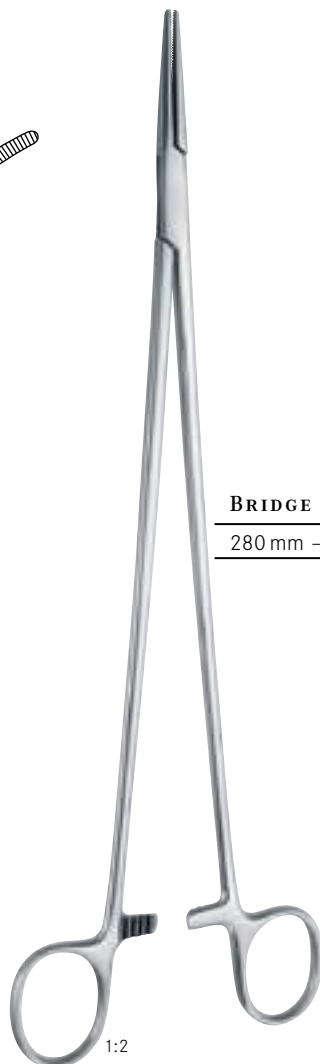

BRIDGE

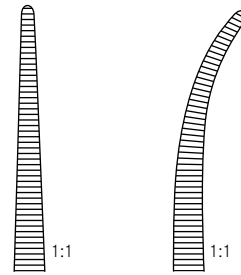

280 mm – 11"	tk 12238-28	tk 12239-28
--------------	--------------------	--------------------

Präparier- und Ligaturklemmen
Dissecting and ligature forceps

Pinces à disséquer et à sutures
Pinzas para preparación y suturas
Pinze per preparazioni e suture

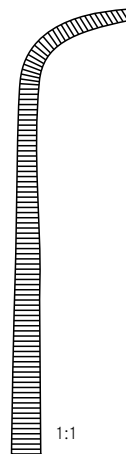
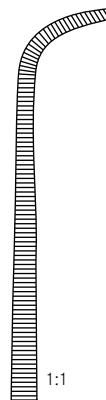
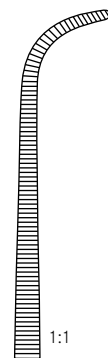
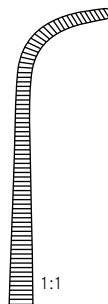
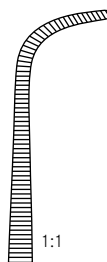
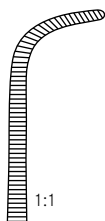
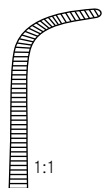
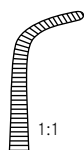

GEMINI

130 mm - 5 "	160 mm - 6 1/4 "	180 mm - 7 "	200 mm - 8 "	230 mm - 9 "	250 mm - 9 3/4 "	280 mm - 11 "	350 mm - 14 "
tk 12290-13	tk 12290-16	tk 12290-18	tk 12290-20	tk 12290-23	tk 12290-25	tk 12290-28	tk 12290-35



MINI-GEMINI

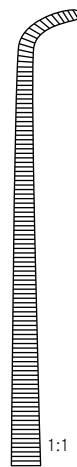
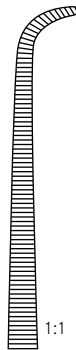
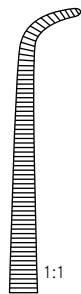
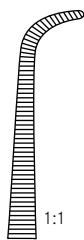

180 mm - 7 "	220 mm - 8 3/4 "	250 mm - 9 3/4 "	280 mm - 11 "
tk 12291-18	tk 12291-22	tk 12291-25	tk 12291-28

Präparier- und Ligaturklemmen
Dissecting and ligature forceps

Pincès à disséquer et à sutures
Pinzas para preparación y suturas
 Pinze per preparazioni e suture



ZENKER

295 mm – 11½"

tk 12267-01

tk 12267-02

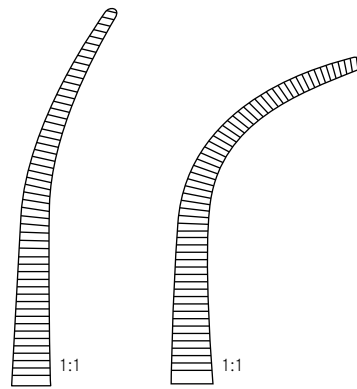

ROBERTS

220 mm – 8¾"

tk 12270-22

tk 12271-22

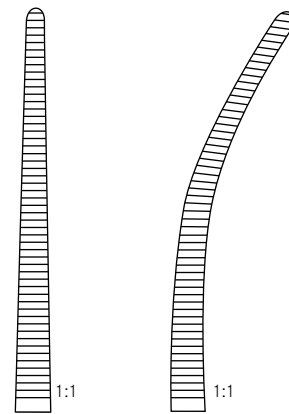

Präparier- und Ligaturklemmen
Dissecting and ligature forceps

Pinces à disséquer et à sutures
Pinzas para preparación y suturas
Pinze per preparazioni e suture



MIXTER

155 mm - 6 "	tk 12300-15
190 mm - 7 1/2 "	tk 12300-19

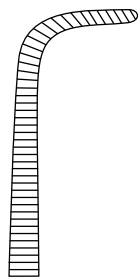

KANTROWITZ

190 mm - 7 1/2 "	tk 12303-19
240 mm - 9 1/2 "	tk 12303-24
265 mm - 10 1/2 "	tk 12303-26

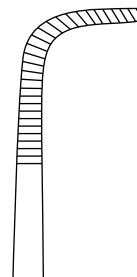

MIXTER

220 mm - 8 3/4 "	tk 12305-22
350 mm - 14 "	tk 12305-35

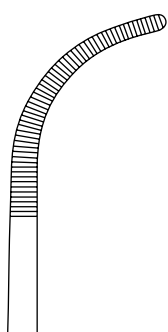

FICKLING

180 mm - 7 "	tk 12236-18	tk 12238-18
--------------	--------------------	--------------------

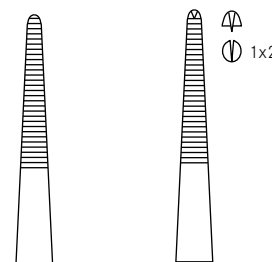

1:2

1:2

Präparier- und Ligaturklemmen
Dissecting and ligature forceps

Pinces à disséquer et à sutures
Pinzas para preparación y suturas
Pinze per preparazioni e suture

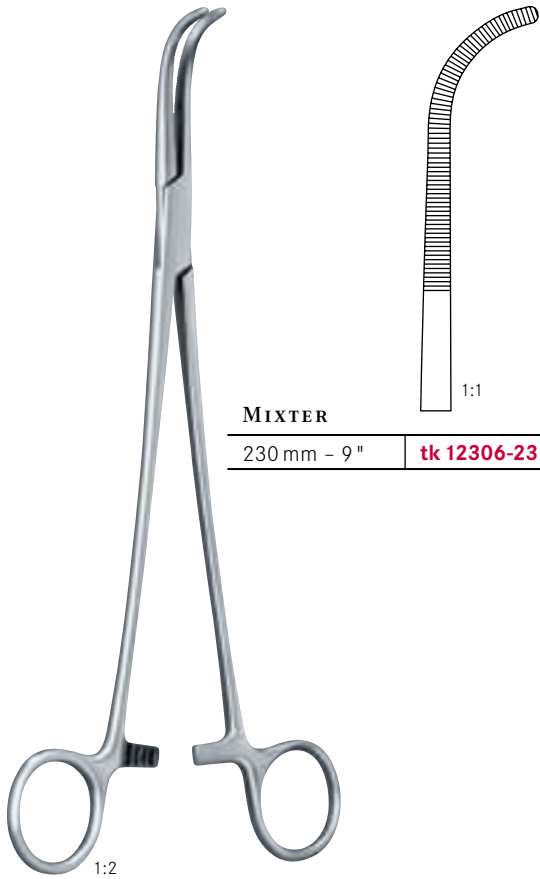

MIXTER
230 mm - 9" **tk 12306-23**

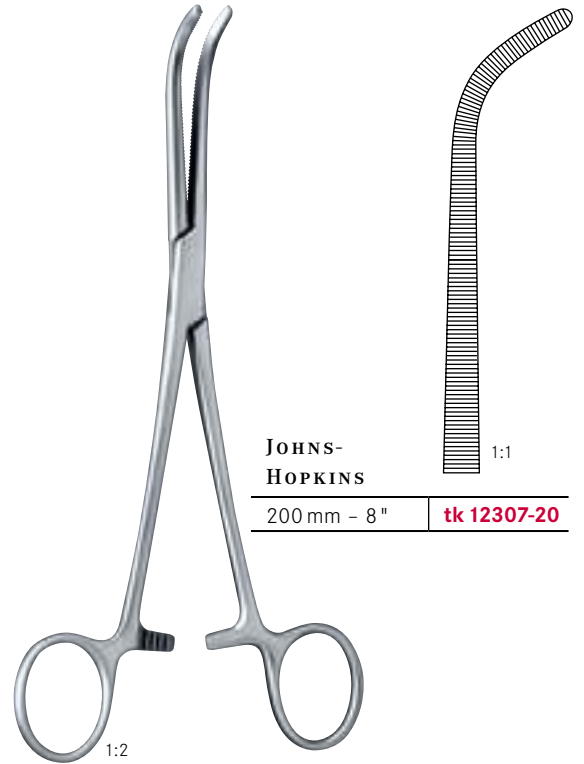

JOHNS-HOPKINS
200 mm - 8" **tk 12307-20**

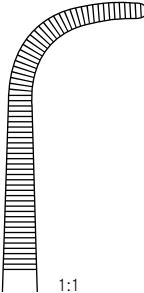
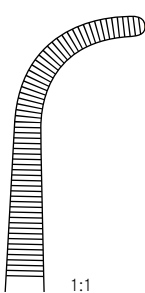
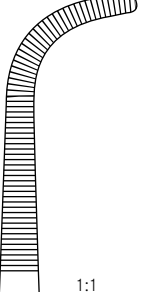
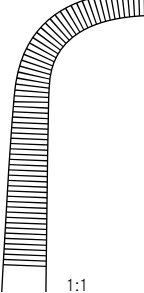

O'SHAUGNESSY

	 1:1	 1:1	 1:1	 1:1
	150 mm - 6"	180 mm - 7"	200 mm - 8"	230 mm - 9"
	tk 12314-15	tk 12314-18	tk 12314-20	tk 12314-23

Präparier- und Ligaturklemmen
Dissecting and ligature forceps

Pinces à disséquer et à sutures
Pinzas para preparación y suturas
Pinze per preparazioni e suture



MIXTER-
O'SHAUGHNESSY

190 mm - 7 1/2" tk 12308-19

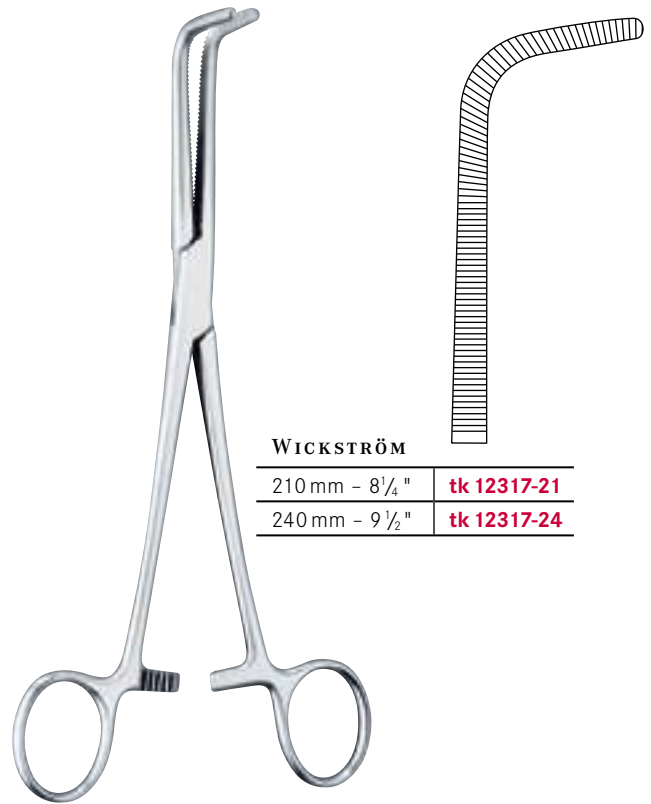

WICKSTRÖM

210 mm - 8 1/4" tk 12317-21

240 mm - 9 1/2" tk 12317-24

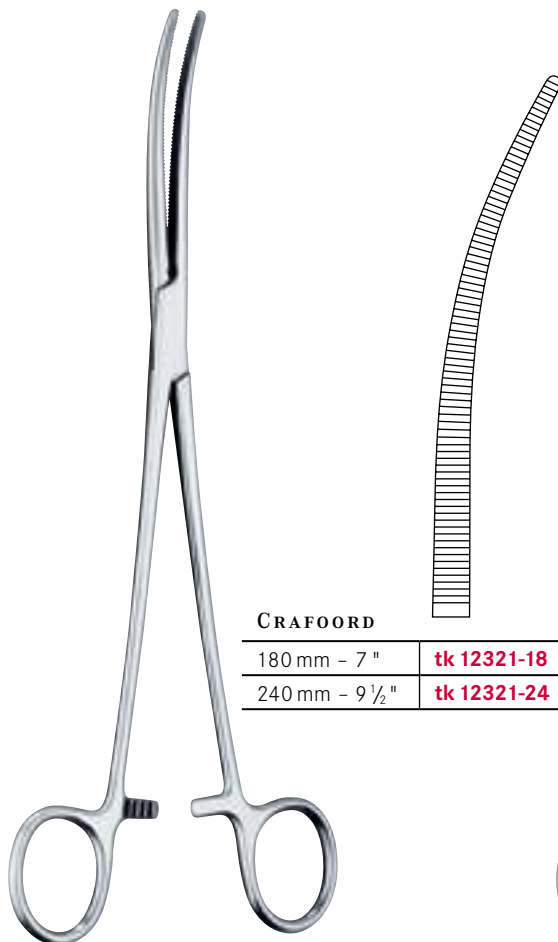

CRAFOORD

180 mm - 7" tk 12321-18

240 mm - 9 1/2" tk 12321-24

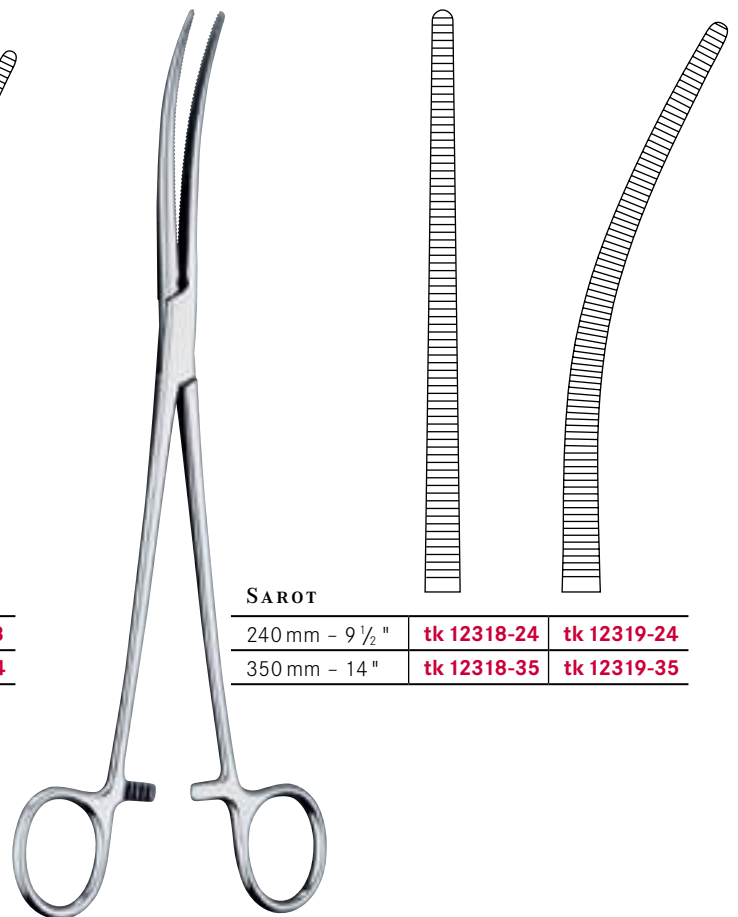

SAROT

240 mm - 9 1/2" tk 12318-24 tk 12319-24

350 mm - 14" tk 12318-35 tk 12319-35

Präparier- und Ligaturklemmen
Dissecting and ligature forceps

Pinces à disséquer et à sutures
Pinzas para preparación y suturas
Pinze per preparazioni e suture



Gallenkanal- und Nierenstielklemmen
Kidney pedicle and gall duct forceps

Pinces pour pédicules renaux et voies biliaires
Pinzas para pediculos renales y conductos biliares
Pinze per peduncoli renali e vie biliari



LOWER
180 mm - 7" tk 12311-18

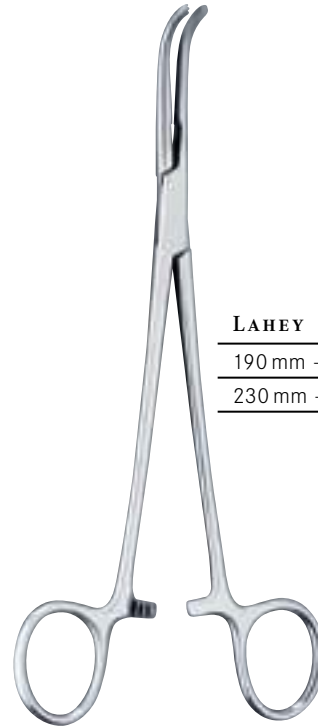
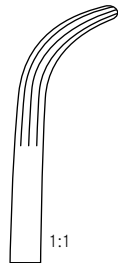

LAHEY
190 mm - 7½" tk 12310-19
230 mm - 9" tk 12310-23

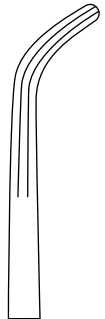

MC QUIGG-MIXTER
220 mm - 8¾" tk 12309-22

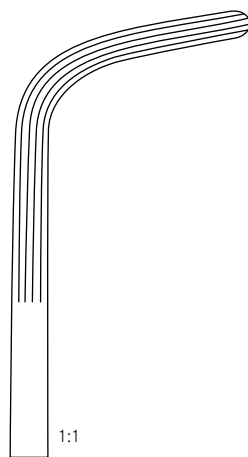

Gallenkanal- und Nierenstielklemmen
Kidney pedicle and gall duct forceps

Pinces pour pédicules renaux et voies biliaires
Pinzas para pediculos renales y conductos biliares
Pinze per peduncoli renali e vie biliari



FINOCHIETTO

240 mm – 9 1/2 " **tk 12312-24**

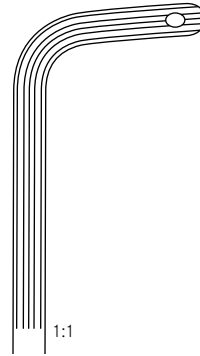

MIXTER

220 mm – 8 3/4 "	250 mm – 9 3/4 "	280 mm – 11 "
tk 12313-22	tk 12315-25	tk 12315-28

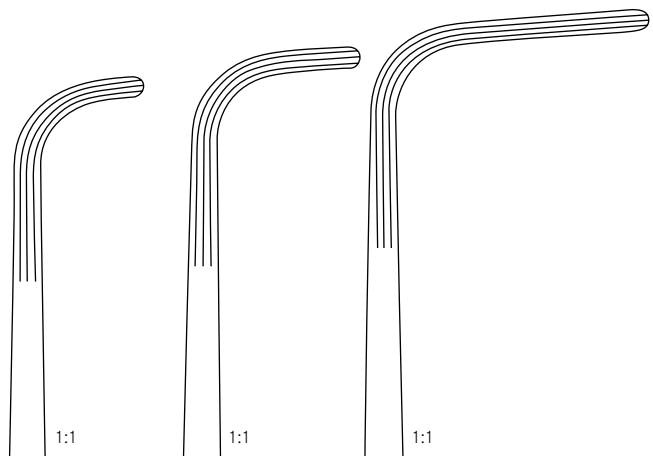

Gallenkanal- und Nierenstielklemmen
Kidney pedicle and gall duct forceps

Pinces pour pédicules renaux et voies biliaires
Pinzas para pediculos renales y conductos biliares
Pinze per peduncoli renali e vie biliari

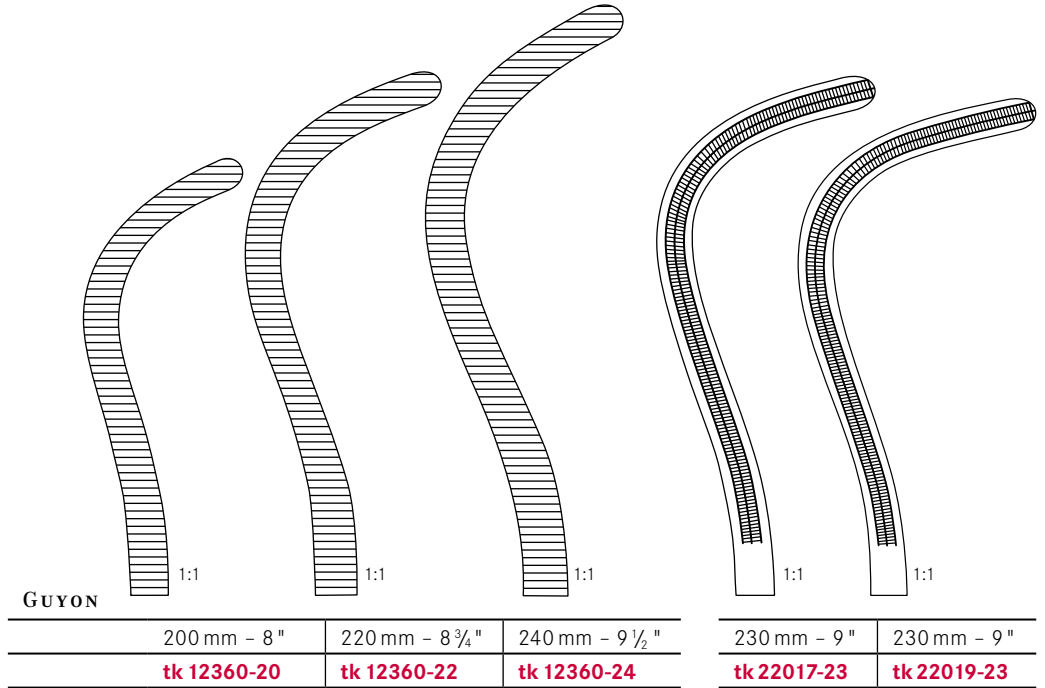

ATRAUMIK

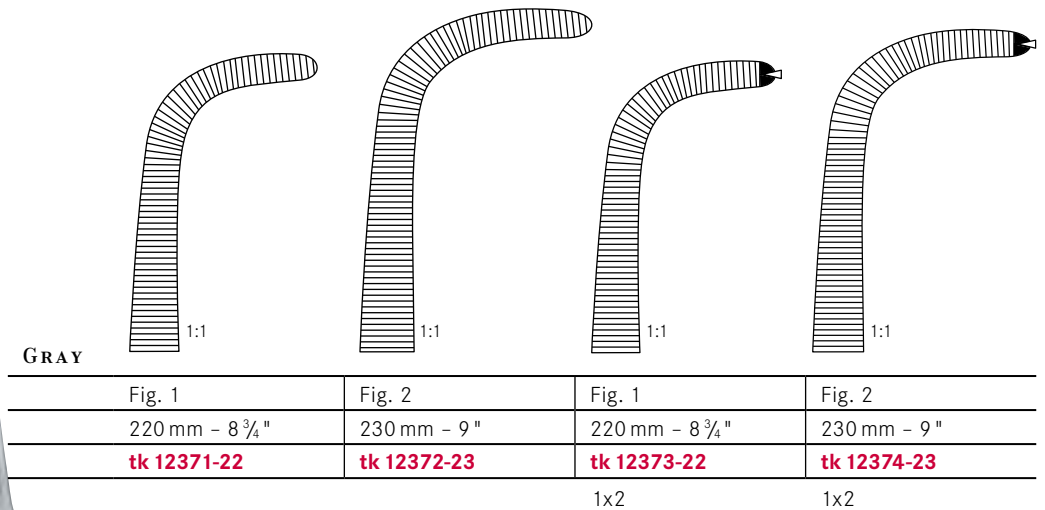

Nierenstielklemmen
Kidney pedicle forceps

Pinces pour pédicules renaux
Pinzas para pediculos renales
Pinze per peduncoli renali

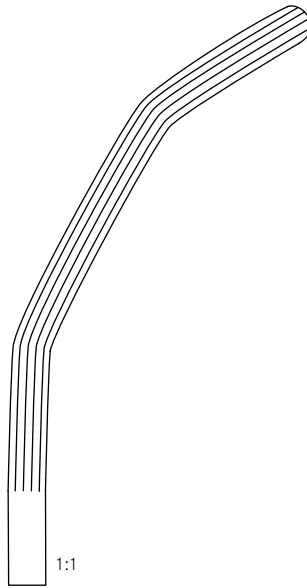

HERRICK
230 mm - 9 " | **tk 12356-23**

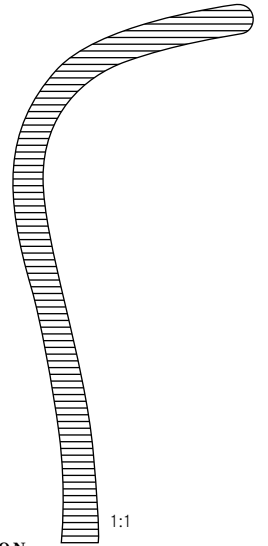

GUYON
230 mm - 9 " | **tk 12357-23**

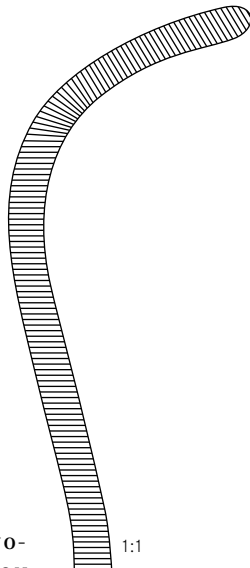

MAYO-GUYON
230 mm - 9 " | **tk 12375-23**

Klemmzangen - Peritoneumklemmen
Clamp forceps - Peritoneal forceps

Pinces-clamps - Pinces pour le péritoine
Pinzas-clamps - Pinzas para peritoneo
Pinze per peritoneo

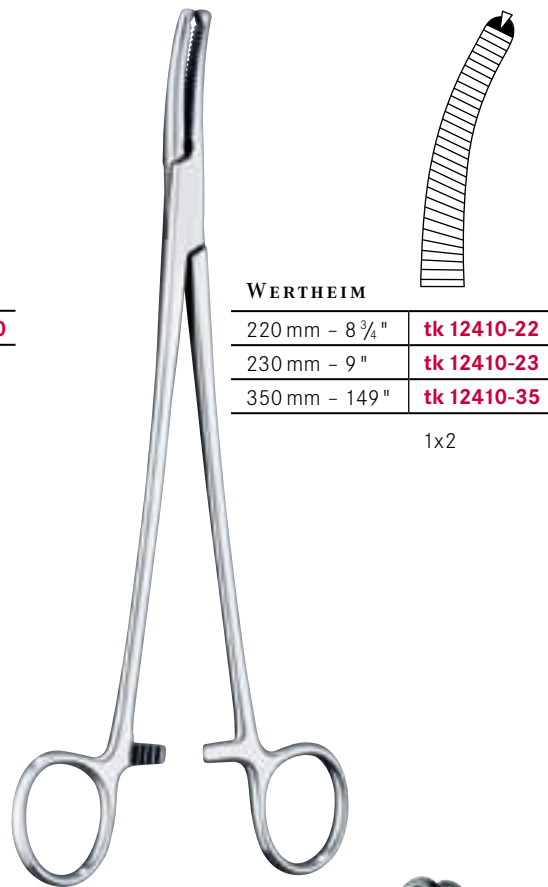
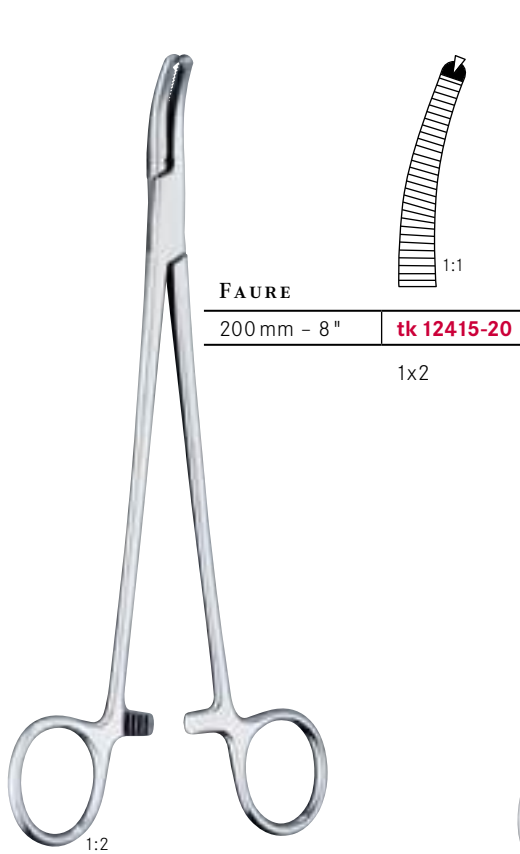

Klemmzangen – Peritoneumklemmen
Clamp forceps – Peritoneal forceps

Pinces-clamps – Pinces pour le péritoine
Pinzas-clamps – Pinzas para peritoneo
Pinze per peritoneo

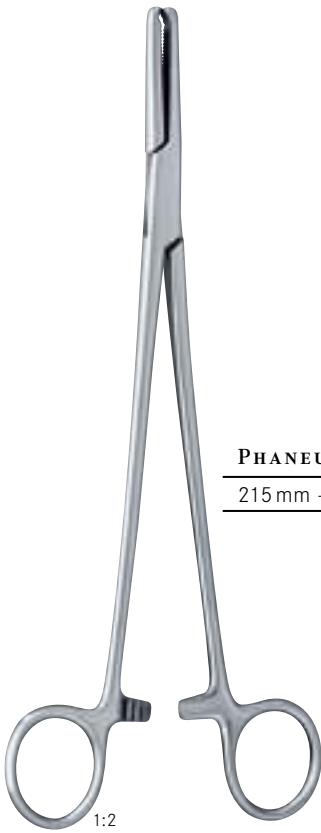

1:2

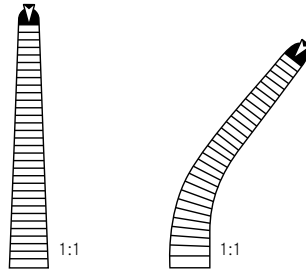

PHANEUF

215 mm – 8 1/2"	tk 12418-21	tk 12419-21
-----------------	-------------	-------------

1x2

1x2



1:2

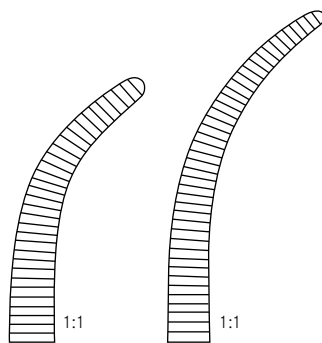

MOYNIHAN

230 mm – 9"	240 mm – 9 1/2"
tk 12423-23	tk 12424-24



1:2

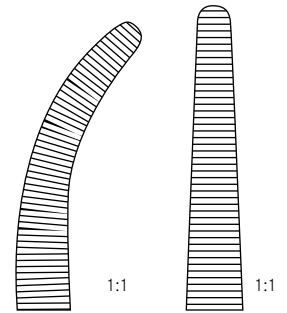

SECOND-LANDAU

230 mm – 9"	tk 12461-24	tk 12460-24
-------------	-------------	-------------

Klemmzangen - Peritoneumklemmen
Clamp forceps - Peritoneal forceps

Pinces-clamps - Pinces pour le péritoine
Pinzas-clamps - Pinzas para peritoneo
Pinze per peritoneo

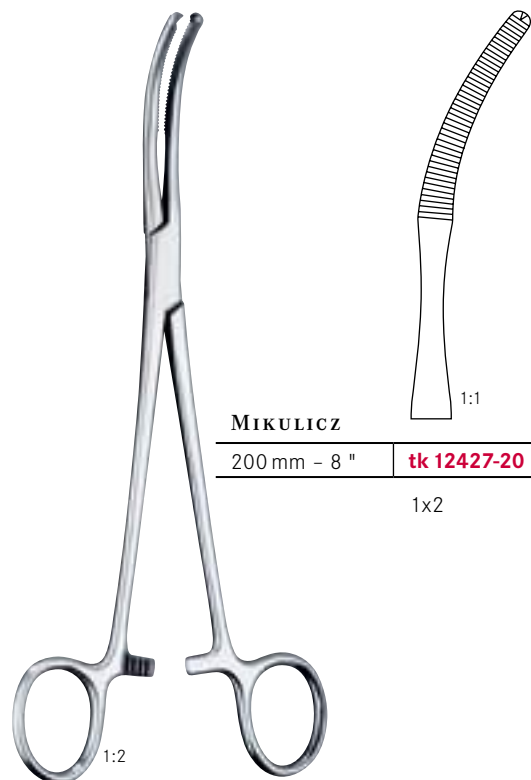

Klemmzangen - Peritoneumklemmen
Clamp forceps - Peritoneal forceps

Pinces-clamps - Pinces pour le péritoine
Pinzas-clamps - Pinzas para peritoneo
Pinze per peritoneo

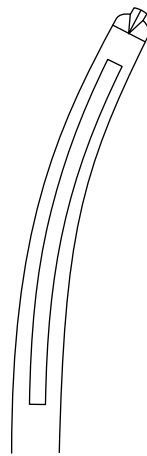

MAINGOT

205 mm - 8"	tk 12433-20
250 mm - 9 3/4"	tk 12433-25

1x2



WERTHEIM

250 mm - 9 3/4"	tk 12432-25
-----------------	--------------------

1:2

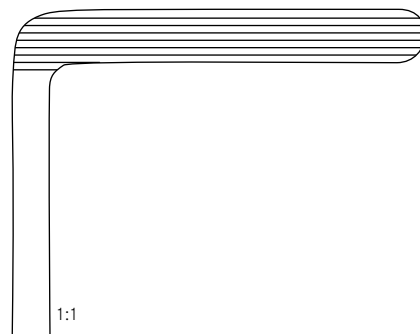

WERTHEIM-
CULLEN

215 mm - 8 1/2"	tk 12440-21
-----------------	--------------------

1:1

1:2

Hysterektomieklemmen
Hysterectomy forceps

Pinces pour hystérectomie
Pinzas para histerectomia
Pinze per isterectomia

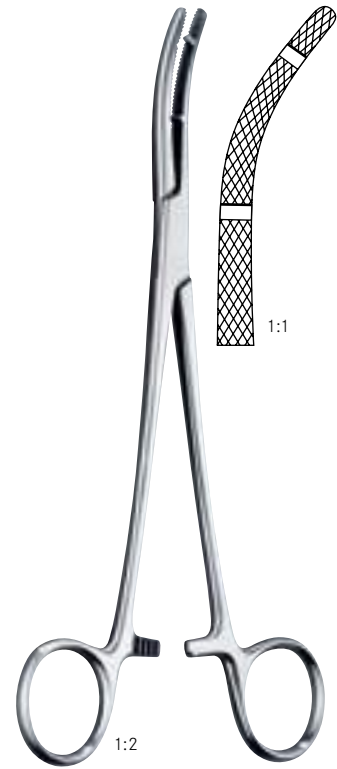
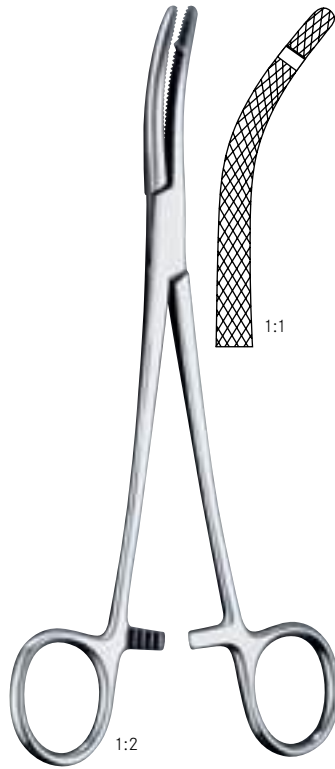

HEANEY

210 mm - 8 1/4"

tk 12435-21

tk 12436-21

230 mm - 9"

tk 12435-23

tk 12436-23



HEANEY-REZEK

210 mm - 8 1/4"

tk 12437-21

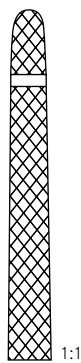

HEANEY-BALLANTINE

210 mm - 8 1/4"

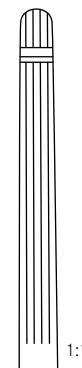

1:1

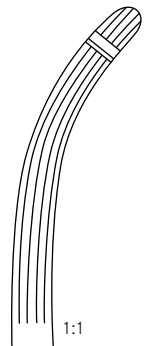

1:1

tk 12438-21

tk 12439-21

Hysterektomieklemmen
Hysterectomy forceps

Pinces pour hystérectomie
Pinzas para histerectomia
Pinze per isterectomia

ATRAUMTK

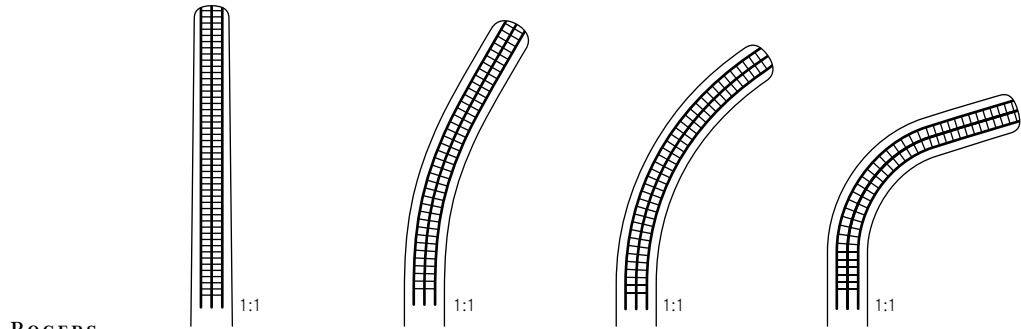

ROGERS

Fig. 1	Fig. 2	Fig. 3	Fig. 4
220 mm - 8 $\frac{3}{4}$ "	215 mm - 8 $\frac{1}{2}$ "	210 mm - 8 $\frac{1}{4}$ "	205 mm - 8"
tk 34147-01	tk 34147-02	tk 34147-03	tk 34147-04

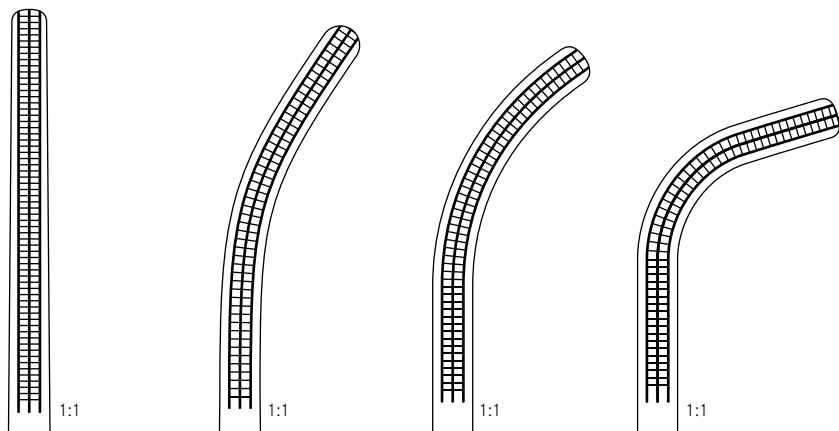
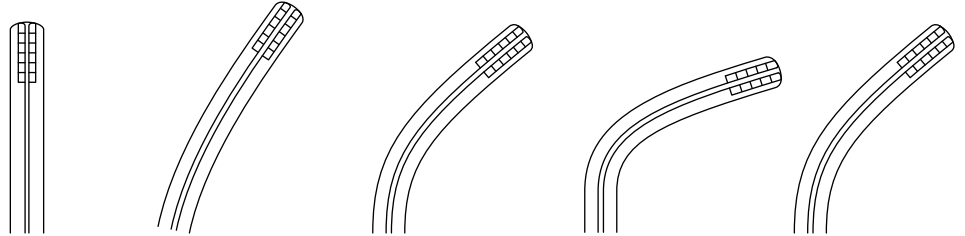
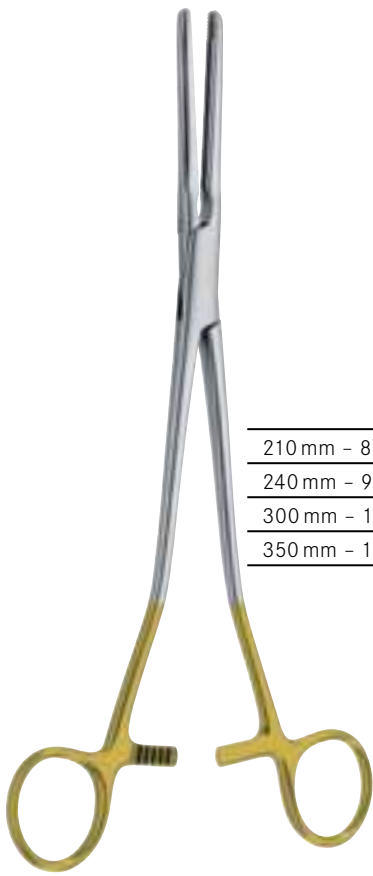

Fig. 1	Fig. 2	Fig. 3	Fig. 4
250 mm - 9 $\frac{3}{4}$ "	250 mm - 9 $\frac{3}{4}$ "	245 mm - 9 $\frac{3}{4}$ "	230 mm - 9"
tk 34148-01	tk 34148-02	tk 34148-03	tk 34148-04

Parametriumklemmen
Parametrium forceps

Pinces parametrium
Pinzas parametrium
Pinze parametrium



210 mm - 8 $\frac{1}{4}$ "	tk 34155-21	tk 34156-21	tk 34157-21	tk 34158-21	tk 34159-21
240 mm - 9 $\frac{1}{2}$ "	tk 34155-24	tk 34156-24	tk 34157-24	tk 34158-24	tk 34159-24
300 mm - 12"	tk 34155-30	tk 34156-30	tk 34157-30	tk 34158-30	tk 34159-30
350 mm - 13 $\frac{3}{4}$ "	tk 34155-35	tk 34156-35	tk 34157-35	tk 34158-35	tk 34159-35

S-förmig gebogen
S-curved
coube en S
curva en S
curva a forma di S

Lungenfasszangen
Lung grasping forceps

Pinces-clamps pour poumons
Pinzas para coger pulmones
Pinza per afferrare il polmone

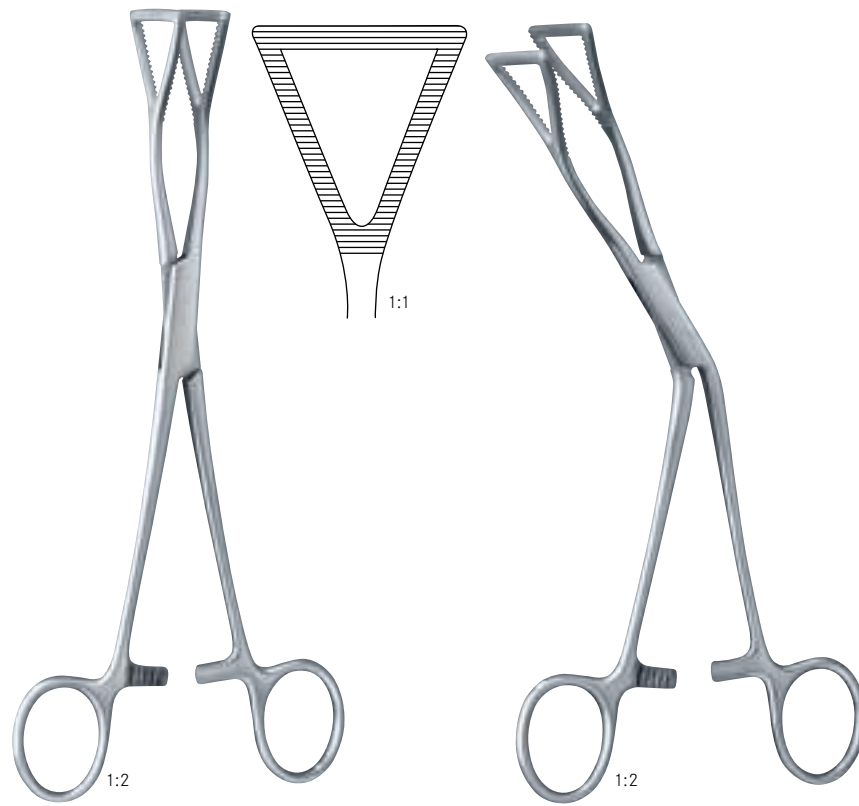

LOVELACE

200 mm - 8"

tk 12495-20

tk 12496-20

Bronchus- und Gefäßklemmen
Bronchus- and vascular clamps

Pinces vasculaires et pour bronches
Pinzas vasculares y bronquiales
Pinze vascolari e per bronchi

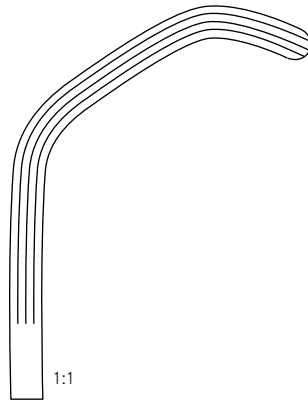

**PRICE-
THOMAS**

220 mm - 8 3/4" **tk 12500-22**

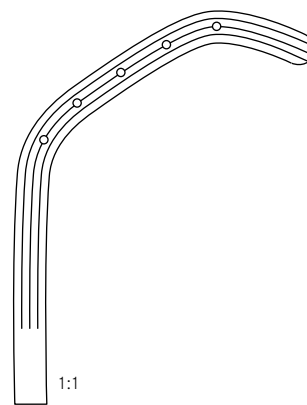
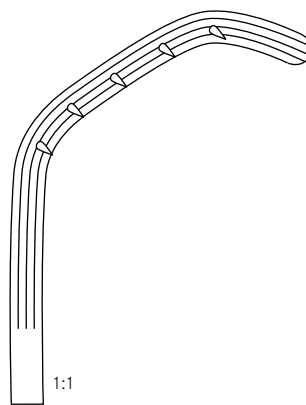

**PRICE-
THOMAS**

220 mm - 8 3/4" **tk 12502-01**

tk 12502-02

Stifte links
Pins left

Goupilles à gauche
Pernos izquierda
Perni a sinistra

Stifte rechts
Pins right

Goupilles à droit
Pernos derecha
Perni a destra

Bronchus- und Gefäßklemmen
Bronchus- and vascular clamps

Pinces vasculaires et pour bronches
Pinza clamps vasculares y bronquiales
 Pinze vascolari e per bronchi

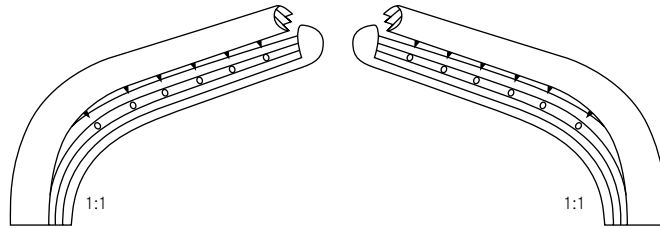

SAROT

230 mm – 9"

tk 12503-23

tk 12504-23

Stifte links
Pins left

Goupilles à gauche
Pernos izquierda
 Perni a sinistra

Stifte rechts
Pins right

Goupilles à droit
Pernos derecha
 Perni a destra

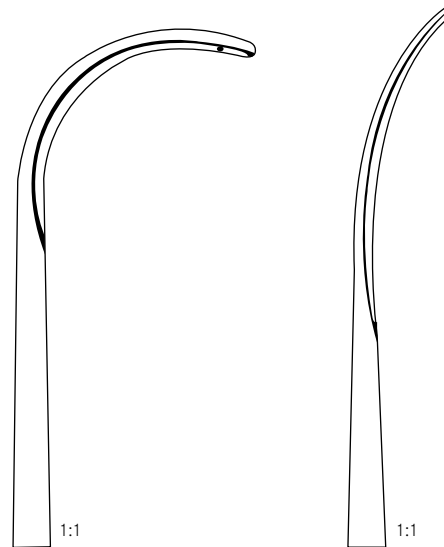

SEMB

240 mm – 9 1/2"

tk 12505-24

tk 12510-24

Bronchus- und Gefäßklemmen
 Bronchus- and vascular clamps

Pinces vasculaires et pour bronches
 Pinzas vasculares y bronquiales
 Pinze vascolari e per bronchi



1:2

BABY-SATINSKY

150 mm - 6"

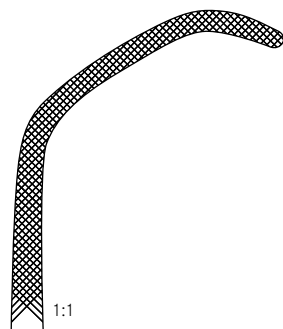

1:1

tk 12545-15



1:2

SATINSKY

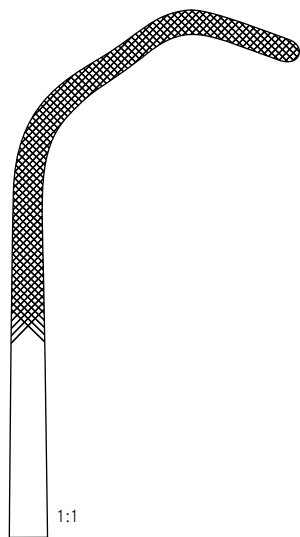

1:1

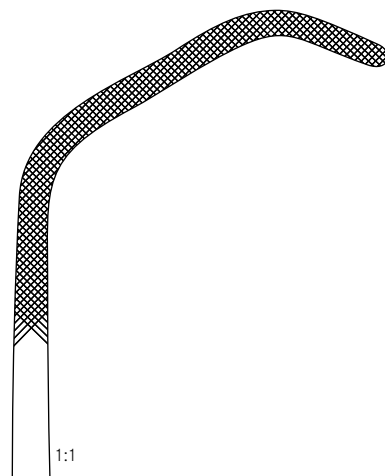

1:1

	Fig. 1	Fig. 1	Fig. 2	Fig. 2
265 mm - 10 1/2"	tk 12550-01	tk 12551-01	tk 12550-02	tk 12551-02

S-förmig gebogen
 S-curved
 courbe en S
 curva en S
 curva a forma di S

S-förmig gebogen
 S-curved
 courbe en S
 curva en S
 curva a forma di S

Tuchklemmen
Towel forceps

Pinces à champs
Pinzas de campo
Pinze fissateli



BERNHARD

100 mm – 4 "	tk 12800-10
120 mm – 4 ¾ "	tk 12800-12
140 mm – 5 ½ "	tk 12800-14
165 mm – 6 ½ "	tk 12800-16
180 mm – 7 "	tk 12800-18



BACKHAUS

90 mm – 3 ½ "	tk 12805-09
110 mm – 4 ¼ "	tk 12805-11
130 mm – 5 "	tk 12805-13
150 mm – 6 "	tk 12805-15



ROEDER

130 mm – 5 "	tk 12802-13
150 mm – 6 "	tk 12802-15



110 mm – 4 " **tk 12807-11**

mit Schlauchhalter
with clip for tube
avec porte-tuyeau
con soporte de tubo
con supporto per tubo

Tuchklemmen
Towel forceps

Pinces à champs
Pinzas de campo
Pinze fissateli



1:2

ROBIN

135 mm - 5 1/4" tk 12809-13

mit Schlauchhalter bis 5 mm Ø
with clip for tube up to 5 mm Ø
avec porte-tuyeau à 5 mm Ø
con soporte de tubo hasta 5 mm Ø
con supporto per tubo fino a 5 mm Ø



JONES

50 mm - 2" tk 12810-05
90 mm - 3 1/2" tk 12810-09



1:2

SCHAEDEL

90 mm - 3 1/2" tk 12820-09



1:2

DOYEN

180 mm - 7" tk 12825-18

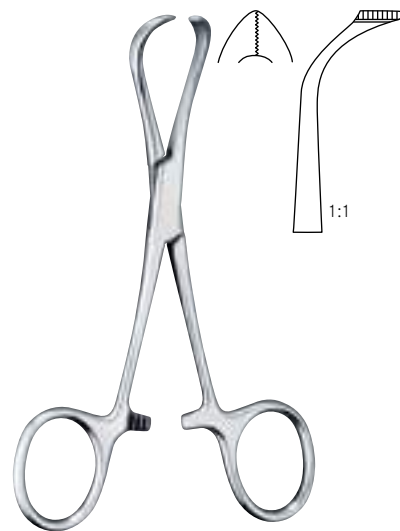

1:1

LORNA

100 mm - 4" tk 12830-10
130 mm - 5" tk 12830-13

Tuchklemmen
Towel forceps

Pinces à champs
Pinzas de campo
Pinze fissateli



LANE

130 mm – 5 "	tk 12840-13
150 mm – 6 "	tk 12840-15
200 mm – 8 "	tk 12840-20

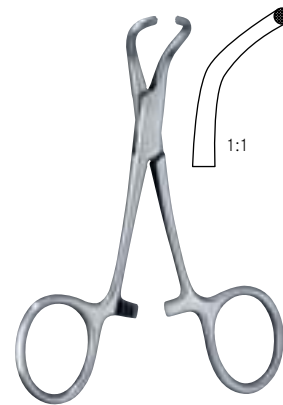

TOHOKU-JAPAN

100 mm – 4 "	tk 12845-10
130 mm – 5 "	tk 12845-13



PEERS-BERTRAM

145 mm – 5 ¾ "	tk 12847-14
----------------	--------------------



90 mm – 3 ½ "	tk 12801-09
115 mm – 4 ½ "	tk 12850-11
130 mm – 5 ¼ "	tk 12850-13

für Papierabdeckung
for paper clothes

pour couvertures en papier
para paños de papel
per copertura di carta

Schlauchklemmen
Tubing clamps

Presse-tubes
Pinzas para tubos
Pinze serratubi



150 mm - 6 "	tk 14100-15
160 mm - 6 1/4 "	tk 14100-16
190 mm - 7 1/2 "	tk 14100-19
240 mm - 9 1/2 "	tk 14100-24



150 mm - 6 "	tk 14101-15
160 mm - 6 1/4 "	tk 14101-16
190 mm - 7 1/2 "	tk 14101-19



165 mm - 6 1/2 "	tk 14110-16
180 mm - 7 "	tk 14110-18

mit Schutzbügel
with protection
avec protection
con protector
con protettore

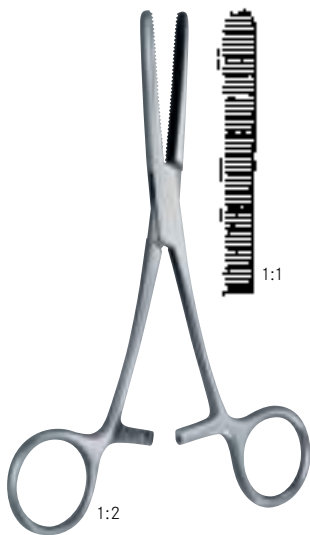

KLINIKUM-
BERLIN

145 mm - 5 3/4 "	tk 14120-14	tk 14114-14
------------------	--------------------	--------------------

mit extra langer Sperre
with extra long ratchet
avec crémaillère extra longue
con cremallera extra larga
con cremagliera extra lunga



150 mm - 6 "	tk 14150-00
--------------	--------------------



GUNNAR	
185 mm - 7 1/4 "	tk 14160-18



Tupferzangen
Cotton swap forceps

Pinces à tampons et à pansements
Pinzas para tapones y vendajes
Pinze per tamponi e per medicazione





Kornzangen
Polypus and dressing forceps

Pinces à polypes et à pansements
Pinzas para pólipos y vendajes
Pinze per medicazione e polipi

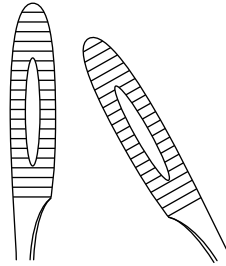
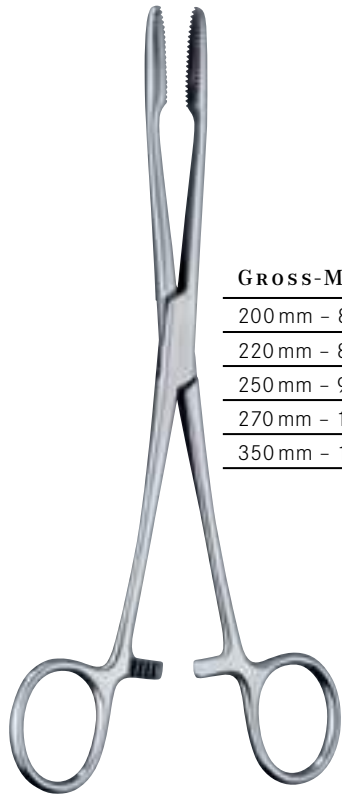

GROSS-MAIER

200 mm - 8"	tk 15110-20	tk 15111-20
220 mm - 8 3/4"	tk 15110-22	tk 15111-22
250 mm - 9 3/4"	tk 15100-25	tk 15101-25
270 mm - 10 3/4"	tk 15100-27	tk 15101-27
350 mm - 13 3/4"	tk 15100-35	tk 15101-35

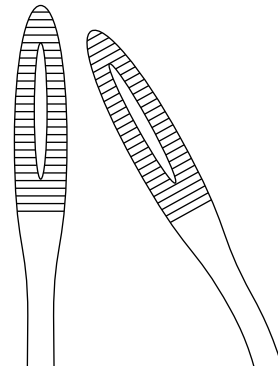

MAIER

200 mm - 8"	tk 15112-20	tk 15113-20
250 mm - 9 3/4"	tk 15102-25	tk 15103-25

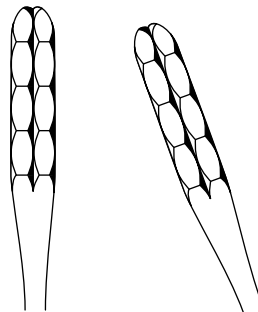

ULRICH

220 mm - 8 3/4"	tk 15120-22	tk 15121-22
250 mm - 9 3/4"	tk 15120-25	tk 15121-25
270 mm - 10 3/4"	tk 15120-27	tk 15121-27
350 mm - 14"	tk 15120-35	tk 15121-35

Schwammzangen
Sponge holding forceps

Pinces à éponges
Pinzas para esponjas
Pinze per tamponi

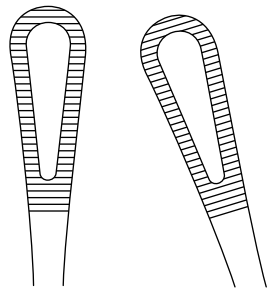
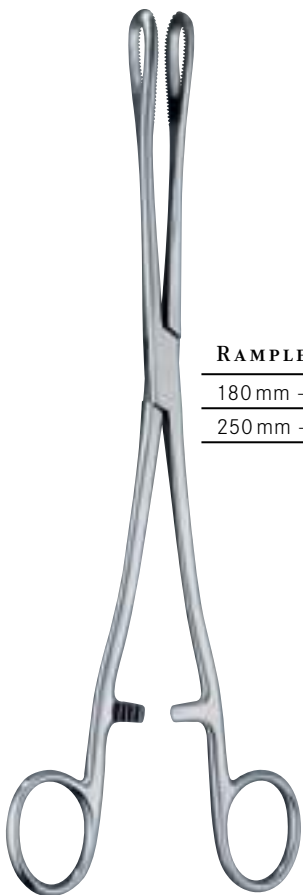

RAMPLEY

180 mm - 7"	tk 15130-18	
250 mm - 9 3/4"	tk 15130-25	tk 15131-25

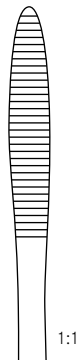

COLLIN

250 mm - 9 3/4"	tk 15150-25
-----------------	--------------------

Schwammzangen
Sponge holding forceps

Pinces à éponges
Pinzas para esponjas
Pinze per tamponi



Schwammzangen
Sponge holding forceps

Pinces à éponges
Pinzas para esponjas
Pinze per tamponi

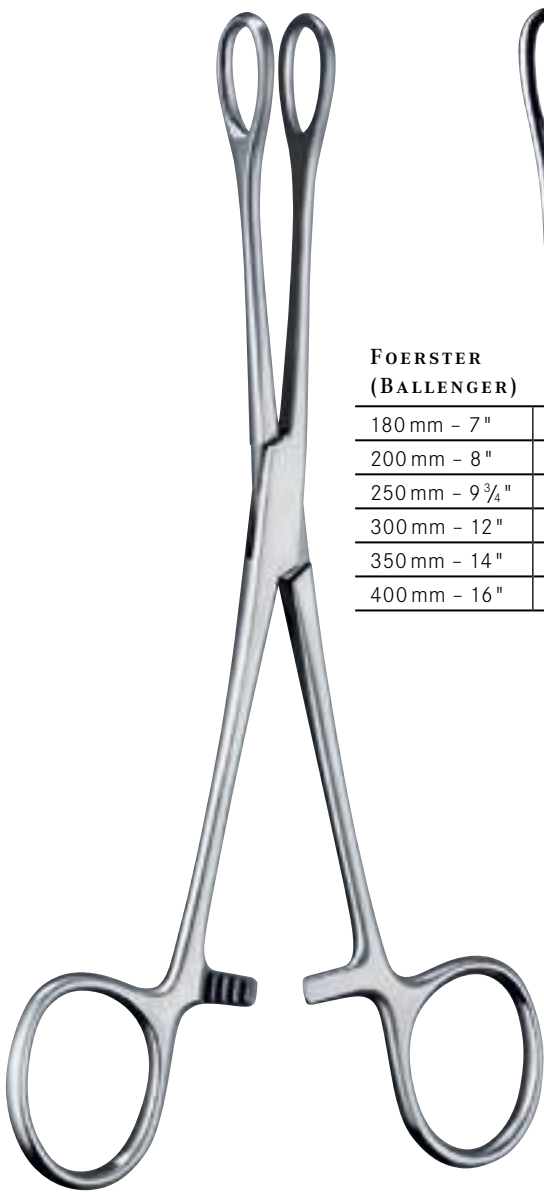

**FOERSTER
(BALLENGER)**

180 mm - 7"	tk 15180-18	tk 15182-18	tk 15183-18	tk 15185-18
200 mm - 8"		tk 15182-20		tk 15185-20
250 mm - 9 3/4"	tk 15180-25	tk 15182-25	tk 15183-25	tk 15185-25
300 mm - 12"		tk 15182-30		
350 mm - 14"		tk 15182-35		
400 mm - 16"		tk 15182-40		

Schwammzangen
Sponge holding forceps

Pinces à éponges
Pinzas para esponjas
Pinze per tamponi



BOZEMANN

260 mm - 10 1/4"

tk 15140-26

S-förmig gebogen
S-curved
courbe en S
curva en S
curve a forma di S

1:2



**BOZEMANN-
DOUGLAS**

260 mm - 10 1/4"

tk 15170-25

S-förmig gebogen
S-curved
courbe en S
curva en S
curve a forma di S

1:2

Kornzangen – Schwammzangen
Polypus and dressing forceps – Sponge holding forceps

Pinces à polypes et à pansements – à tampons et éponges
Pinzas para pólipos y vendajes – para tapónes y esponjas
 Pinze per medicazione e polipi – Pinze per tamponi

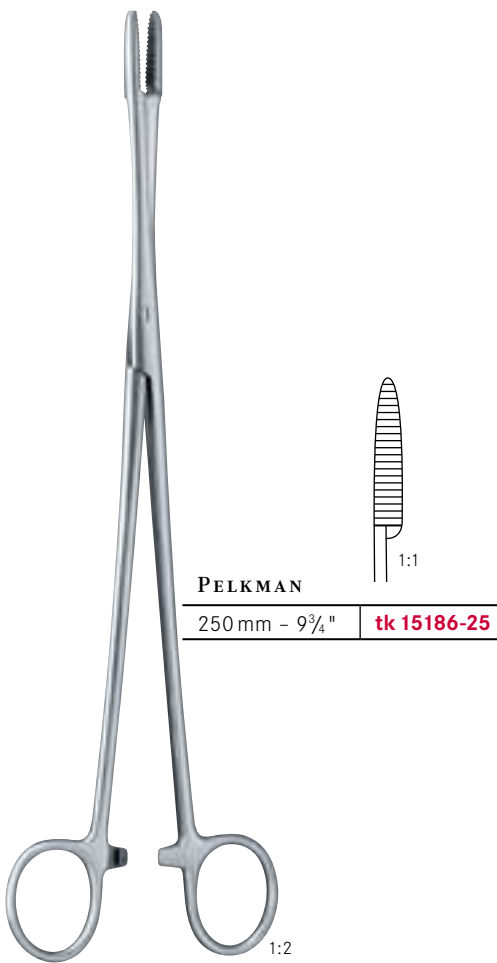

Kornzangen – Schwammzangen
Polypus and dressing forceps – Sponge holding forceps

Pinces à polypes et à pansements – à tampons et éponges
Pinzas para pólipos y vendajes – para tapones y esponjas
 Pinze per medicazione e polipi – Pinze per tamponi

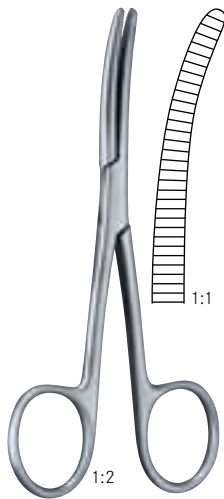

BRYANT

130 mm – 5"	tk 15305-13
-------------	--------------------

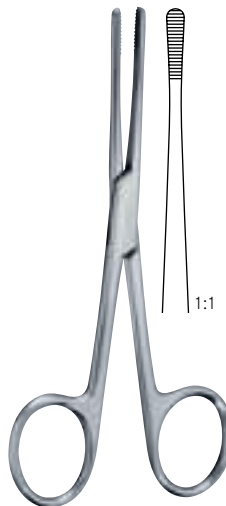

**LISTER
(SINUS)**

130 mm – 5"	tk 15300-13
160 mm – 6 1/4"	tk 15300-16
180 mm – 7"	tk 15300-18

Sinusklemmen
Sinus forceps
 Pinces à sinus
Pinza para el sinus
 Pinze per seni



DUPLAY

200 mm – 8"	tk 15220-20	tk 15221-20
-------------	--------------------	--------------------

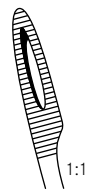
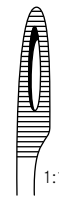



Wundhaken
Retractors

Ecarteurs
Separadores
Divaricatori



Nasenhäkchen
Nasal hooks

Crochets nasales
Ganchitos nasales
Uncini nasali



KILNER

150 mm - 6"

tk 48128-15



JOSEPH

150 mm - 6"

tk 16900-15



LANGE

220 mm - 8³/₄"

tk 16901-22



COTTLE

160 mm - 6¹/₄"

tk 16902-16



FOMON

170 mm - 6³/₄"

tk 16904-17



COTTLE

150 mm - 6"



1:1

tk 16905-01



1:1

tk 16905-02



1:1

tk 16905-03

Nasenhäkchen
Nasal hooks

Crochets nasales
Ganchitos nasales
Uncini nasali



1:2

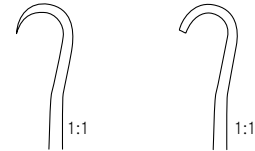

1:1 1:1

ITERSON		
160 mm – 6¼"	tk 16920-16	tk 16922-16
scharf <i>sharp</i>	stumpf <i>blunt</i>	
pointu <i>agudo</i>	mousse <i>romo</i>	
acuto	smusso	



1:2

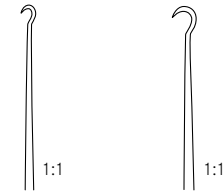

1:1 1:1

GILLIES		
	Fig. 1	Fig. 2
180 mm – 7"	tk 48130-01	tk 48130-02



1:2

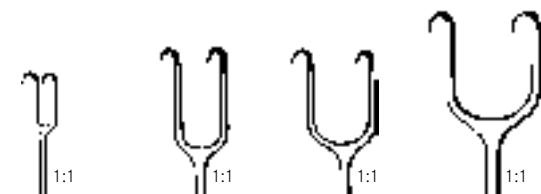

1:1 1:1 1:1 1:1

JOSEPH				
	2 mm	5 mm	7 mm	10 mm
160 mm – 6¼"	tk 16910-02	tk 16910-05	tk 16910-07	tk 16910-10

Nasenhäkchen
Nasal hooks

Crochets nasales
Ganchitos nasales
Uncini nasali



**COTTLE-
NEIVERT**

200 mm - 8"

tk 16912-20

1:2



FOMON

160 mm - 6¼"

tk 16914-16

1:2



COTTLE

150 mm - 6"

tk 16915-01

tk 16915-02

tk 16915-03

1:2



1:1



1:1



1:1



NEIVERT

160 mm - 6¼"

tk 16916-16

1:2

Nasen- und Trachealhäkchen
Trachea and nose retractors

Ecarteurs nasales et tracheales
Separadores traqueales y nasales
Uncini tracheali e nasali



COTTLE

150 mm – 6"

tk 16917-15

tk 16918-15



1:2

KILNER

100 mm – 4"

tk 16907-10



1:2

CONVERSE

120 mm – 4¾"

tk 16908-12



LUKENS

170 mm – 6⅔"

tk 16933-17

stumpf

blunt

mousse

romo

smusso

1:2



1:2

AUFRICHT

160 mm – 7¼"

tk 16906-56

190 mm – 7½"

tk 16906-59



1:2

AUFRICHT

160 mm – 7¼"

tk 16906-16

190 mm – 7½"

tk 16906-19

Trachealhäkchen
Trachea retractors

Ecarteurs tracheales
Separadores traqueales
Uncini tracheali

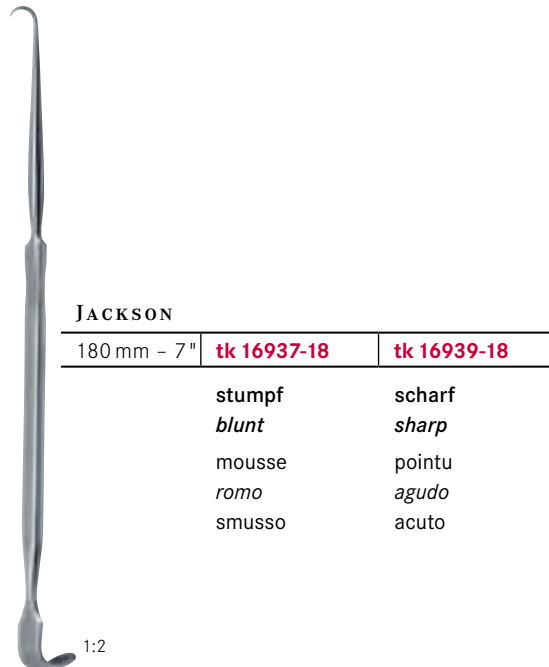
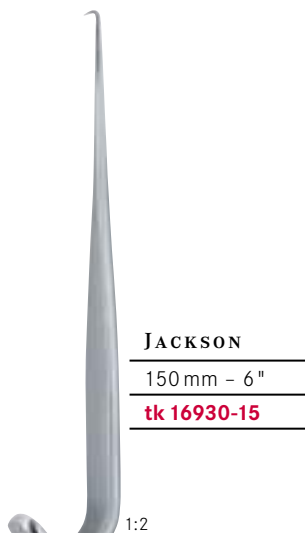
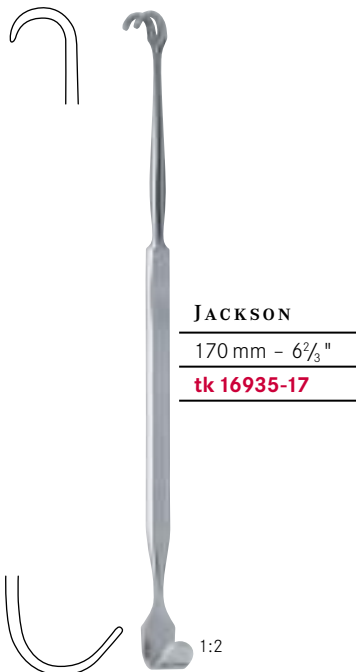

Wundhaken
Retractors

Ecarteurs
Separadores
Divaricatori

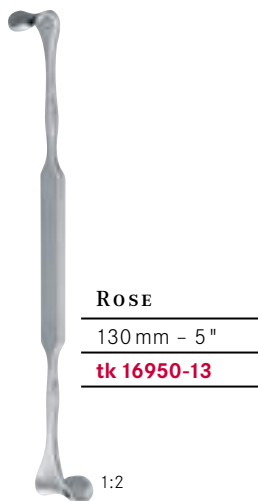

Wundhaken
Retractors

Ecarteurs
Separadores
Divaricatori



EMMET

	Fig. 1	Fig. 2	Fig. 3	Fig. 4	Fig. 5
220 mm – 8 $\frac{3}{4}$ "	tk 16958-01	tk 16958-02	tk 16958-03	tk 16958-04	tk 16958-05

1:2

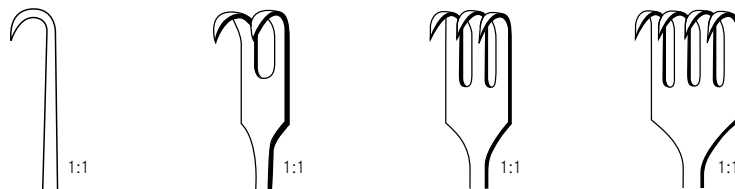

160 mm – 6 $\frac{1}{4}$ "	tk 17001-16	tk 17002-16	tk 17003-16	tk 17004-16
----------------------------	--------------------	--------------------	--------------------	--------------------

scharf
sharp
pointu
agudo
acuto

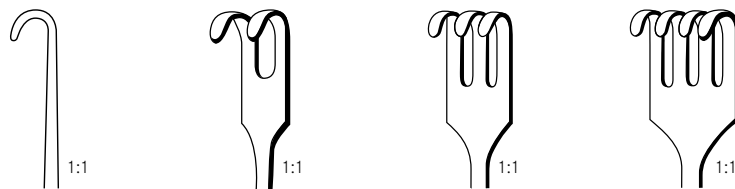

160 mm – 6 $\frac{1}{4}$ "	tk 17011-16	tk 17012-16	tk 17013-16	tk 17014-16
----------------------------	--------------------	--------------------	--------------------	--------------------

stumpf
blunt
mousse
romo
smusso

1:2

Wundhaken | Ecarteurs
 Retractors | Separadores
 Divaricatori



1:2



1:1

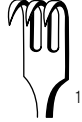

1:1

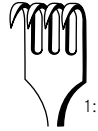

1:1

160 mm - 6 1/4"	tk 17021-16	tk 17022-16	tk 17024-16
-----------------	--------------------	--------------------	--------------------

flexibel, scharf
flexible, sharp
 flexible, pointu
flexible, agudo
 flessibile, acuto



1:1

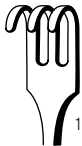

1:1

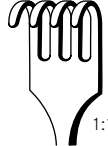

1:1

160 mm - 6 1/4"	tk 17031-16	tk 17032-16	tk 17034-16
-----------------	--------------------	--------------------	--------------------

flexibel, stumpf
flexible, blunt
 flexible, mousse
flexible, romo
 flessibile, smusso

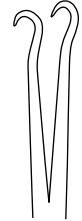

1:1

BARSKY
155 mm - 6"
tk 17027-15

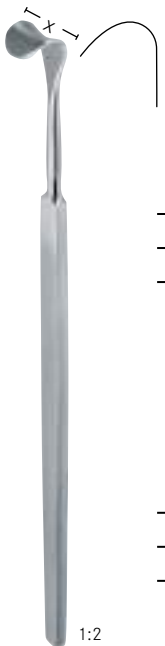

1:1

DESMARRES



1:1



1:1



1:1

	x = 8 mm	x = 10 mm	x = 12 mm
160 mm - 6 1/4"	tk 17038-08	tk 17038-10	tk 17038-12



1:1



1:1

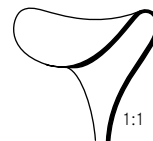

1:1

	x = 14 mm	x = 16 mm	x = 18 mm
160 mm - 6 1/4"	tk 17038-14	tk 17038-16	tk 17038-18

1:2



1:1

KNAPP (ROLLET)
160 mm - 6 1/4"
tk 17025-16

flexibel, scharf
flexible, sharp
 flexible, pointu
flexible, agudo
 flessibile, acuto

Wundhaken
Retractors

Ecarteurs
Separadores
Divaricatori



1:2



1:1

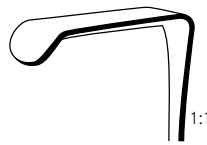

1:1

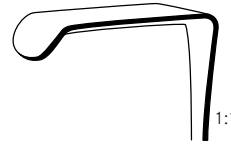

1:1

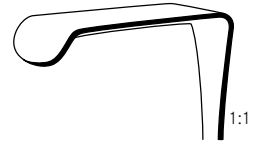

1:1

MINI-LANGENBECK

	10 mm x 6 mm	17 mm x 5 mm	20 mm x 6 mm	22 mm x 8 mm
160 mm – 6¼"	tk 17039-10	tk 17039-17	tk 17039-20	tk 17039-22



1:2



1:1

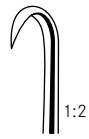

1:2



1:2



1:2



1:2



1:2

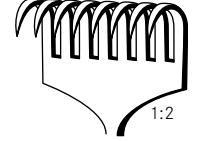

1:2

KOCHER

220 mm – 8¾"	tk 17041-22	tk 17042-22	tk 17043-22	tk 17044-22	tk 17046-22	tk 17048-22
--------------	-------------	-------------	-------------	-------------	-------------	-------------

scharf
sharp
pointu
agudo
acuto



1:1

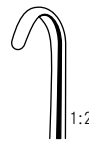

1:2



1:2



1:2



1:2



1:2

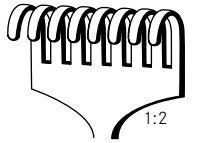

1:2

220 mm – 8¾"	tk 17051-22	tk 17052-22	tk 17053-22	tk 17054-22	tk 17056-22	tk 17058-22
--------------	-------------	-------------	-------------	-------------	-------------	-------------

stumpf
blunt
mousse
romo
smusso

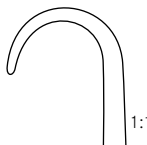

1:1

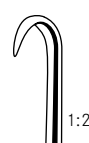

1:2



1:2



1:2



1:2



1:2

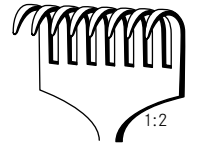

1:2

220 mm – 8¾"	tk 17059-01	tk 17059-02	tk 17059-03	tk 17059-04	tk 17059-06	tk 17059-08
--------------	-------------	-------------	-------------	-------------	-------------	-------------

halbscharf
semi-sharp
semi-pointu
semi-agudo
semi-acuto

Wundhaken
Retractors

Ecarteurs
Separadores
Divaricatori



1:2

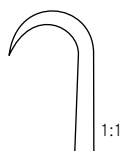

1:1

VOLKMANN

215 mm - 8½"



1:2

tk 17061-21



1:2

tk 17062-21



1:2

tk 17063-21



1:2

tk 17064-21

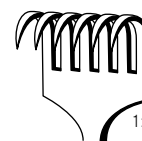

1:2

tk 17066-21

scharf
sharp
pointu
agudo
acuto

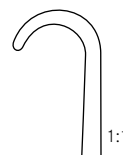

1:1

215 mm - 8½"



1:2

tk 17071-21

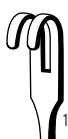

1:2

tk 17072-21



1:2

tk 17073-21



1:2

tk 17074-21

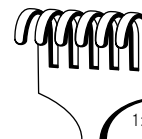

1:2

tk 17076-21

stumpf
blunt
mousse
romo
smusso

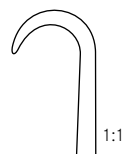

1:1

215 mm - 8½"



1:2

tk 17078-01



1:2

tk 17078-02



1:2

tk 17078-03



1:2

tk 17078-04

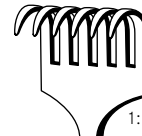

1:2

tk 17078-06

halbscharf
semi-sharp
semi-pointu
semi-agudo
semi-acuto

Wundhaken
Retractors

Ecarteurs
Separadores
Divaricatori



1:2

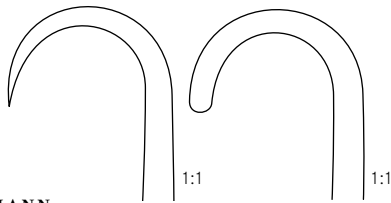

VOLKMANN
215 mm – 8½" tk 17040-01 tk 17040-02

scharf	stumpf
sharp	blunt
pointu	mousse
agudo	romo
acuto	smusso

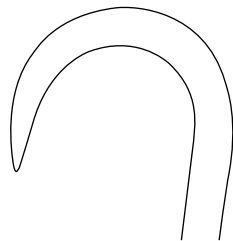

VOLKMANN
215 mm – 8½" tk 17040-03

scharf
sharp
pointu
agudo
acuto

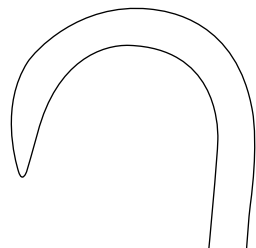

VOLKMANN
245 mm – 8½" tk 17040-05

scharf
sharp
pointu
agudo
acuto



1:2

1:1

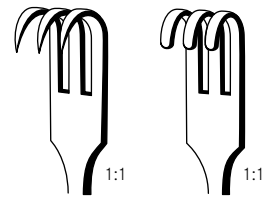

SENN-MILLER
160 mm – 6¼" tk 17080-16 tk 17081-16

scharf	stumpf
sharp	blunt
pointu	mousse
agudo	romo
acuto	smusso

1:1



13 mm x 5 mm

KILNER
155 mm – 6" tk 17082-15



1:2

1:1

Wundhaken
Retractors

Ecarteurs
Separadores
Divaricatori

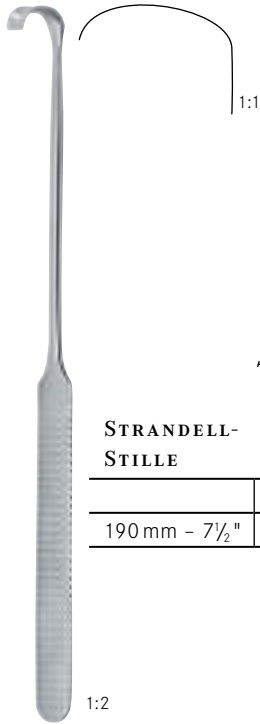

STRANDELL-
STILLE

	20 mm x 6 mm	20 mm x 6 mm
190 mm - 7½"	tk 17079-01	tk 17079-02

gezahnt
saw edge
dentelé
dentado
dentato

1:2

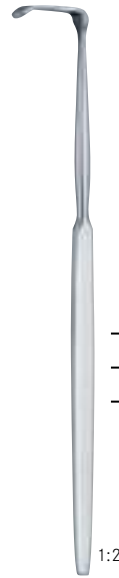

SENN-GREEN

	20 mm x 6 mm	10 mm x 6 mm
150 mm - 6"	tk 17083-01	tk 17083-02

1:2

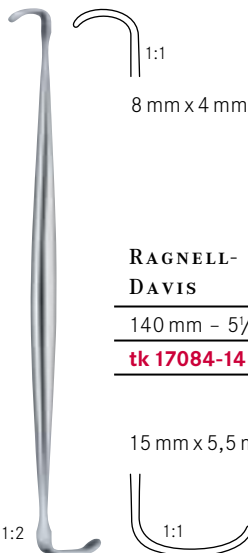

RAGNELL-
DAVIS

140 mm - 5½"	tk 17084-14
--------------	--------------------

15 mm x 5,5 mm

1:2



COTTLE

150 mm - 6"	tk 17085-15
-------------	--------------------

1:2



CRILE

110 mm - 4¼"	tk 17088-11
--------------	--------------------

1:2

Wundhaken
Retractors

Ecarteurs
Separadores
Divaricatori

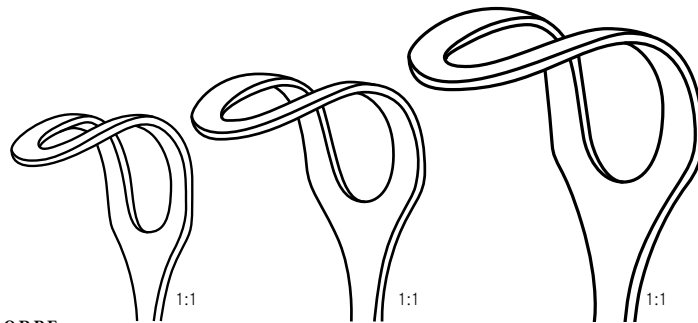

MIDDELDORPF

	14 mm x 17 mm	20 mm x 22 mm	26 mm x 30 mm
	215 mm – 8½"	220 mm – 8¾"	235 mm – 9¼"
	tk 17085-21	tk 17086-22	tk 17087-23



1:2



MEYERDING

	18 mm x 7 mm	10 mm x 3 mm
180 mm – 7"	tk 17090-18	tk 17091-18



	16 mm x 5 mm	7 mm x 4 mm
180 mm – 7"	tk 17092-18	tk 17093-18

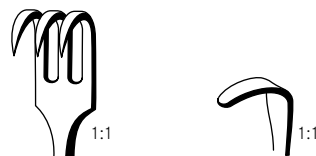

	10 mm x 4 mm	7 mm x 4 mm
180 mm – 7"	tk 17094-18	tk 17095-18

Wundhaken | Ecarteurs
 Retractors | Separadores
 Divaricatori



1:2

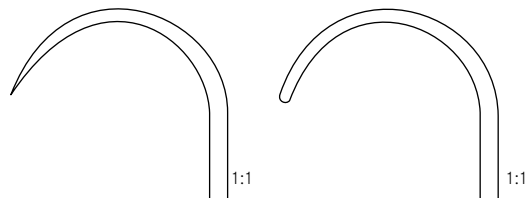

KOERTE

	26 mm x 40 mm	26 mm x 40 mm
235 mm - 9 1/4"	tk 17096-08	tk 17097-08

scharf
 sharp
 pointu
 agudo
 acuto

stumpf
 blunt
 mousse
 romo
 smusso



1:2

GREEN

215 mm - 8 1/2"	tk 17099-21
-----------------	--------------------

Wundhaken | Ecarteurs
Retractors | Separadores
Divaricatori

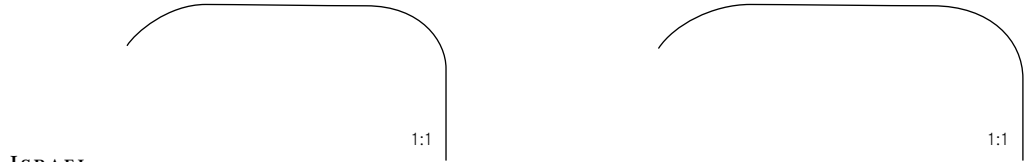
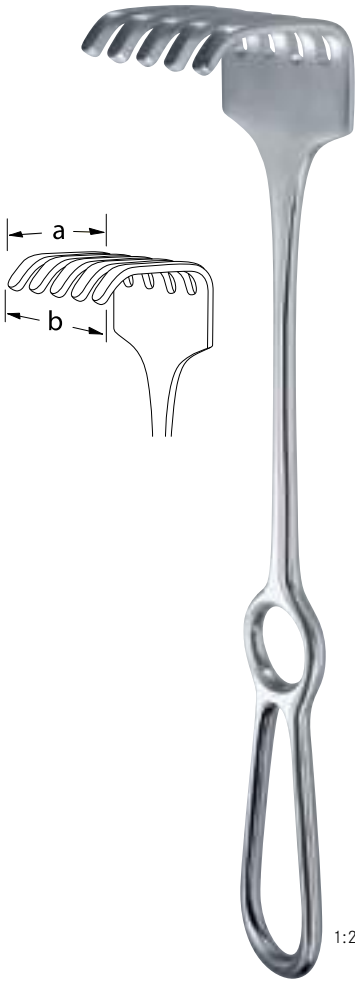

ISRAEL	a = 40 mm - b = 40 mm	a = 45 mm - b = 50 mm
250 mm - 9 3/4"	tk 17100-25	tk 17101-25

4 Zähne
4 Teeth
4 Dents
4 Dientes
4 Denti

5 Zähne
5 Teeth
5 Dents
5 Dientes
5 Denti

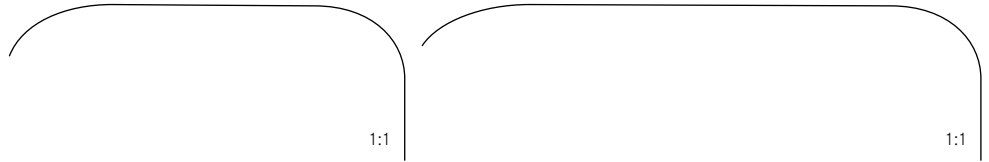

	a = 50 mm - b = 60 mm	a = 70 mm - b = 70 mm
250 mm - 9 3/4"	tk 17102-25	tk 17103-25

6 Zähne
6 Teeth
6 Dents
6 Dientes
6 Denti

6 Zähne
6 Teeth
6 Dents
6 Dientes
6 Denti



LANGENBECK	Fig. 1	Fig. 2	Fig. 3
	30 mm x 11 mm	30 mm x 14 mm	30 mm x 16 mm
220 mm - 8 3/4"	tk 17110-01	tk 17110-02	tk 17110-03



	Fig. 4	Fig. 5
	40 mm x 11 mm	50 mm x 11 mm
220 mm - 8 3/4"	tk 17110-04	tk 17110-05

Wundhaken
Retractors

Ecarteurs
Separadores
Divaricatori



LANGENBECK



	Fig. 1	Fig. 2	Fig. 3
	30 mm x 11 mm	30 mm x 14 mm	30 mm x 16 mm
210 mm - 8 1/4"	tk 17112-01	tk 17112-02	tk 17112-03

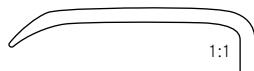
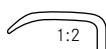

	Fig. 4	Fig. 5
	40 mm x 11 mm	50 mm x 11 mm
210 mm - 8 1/4"	tk 17112-04	tk 17112-05

1:2



KOCHER-LANGENBECK
(OBWEGESER)



	25 mm x 7 mm	35 mm x 8 mm	35 mm x 11 mm	35 mm x 15 mm
215 mm - 8 1/2"	tk 17114-01	tk 17114-02	tk 17114-03	tk 17114-04

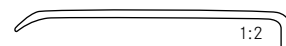
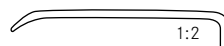
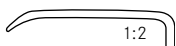

	42 mm x 10 mm	55 mm x 12 mm	70 mm x 14 mm
215 mm - 8 1/2"	tk 17114-05	tk 17114-06	tk 17114-07

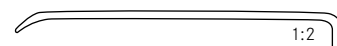
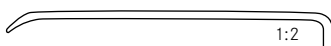

	80 mm x 12 mm	80 mm x 16 mm
215 mm - 8 1/2"	tk 17114-08	tk 17114-09

1:2

Wundhaken
Retractors

Ecarteurs
Separadores
Divaricatori

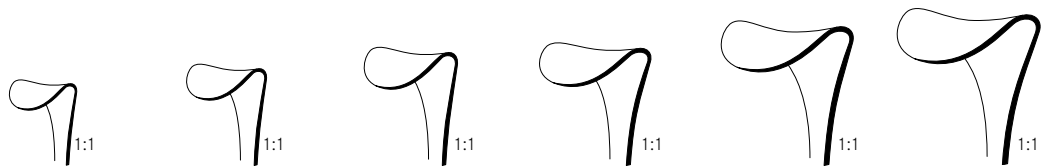

CUSHING

	x = 8 mm	x = 10 mm	x = 12 mm	x = 14 mm	x = 16 mm	x = 18 mm
200 mm – 8"	tk 17200-08	tk 17200-10	tk 17200-12	tk 17200-14	tk 17200-16	tk 17200-18
240 mm – 9½"	tk 17201-08	tk 17201-10	tk 17201-12	tk 17201-14	tk 17201-16	tk 17201-18



OBWEGESER

	42 mm x 13 mm	60 mm x 12 mm
220 mm – 8¾"	tk 52715-01	tk 52715-02

	80 mm x 16 mm
220 mm – 8¾"	tk 52715-03

Wundhaken | Ecarteurs
 Retractors | Separadores
 Divaricatori



	1:1	1:1
OBWEGESER		
	44 mm x 9,5 mm	70 mm x 11,5 mm
220 mm - 8 3/4"	tk 52717-22	tk 52719-22

1:2

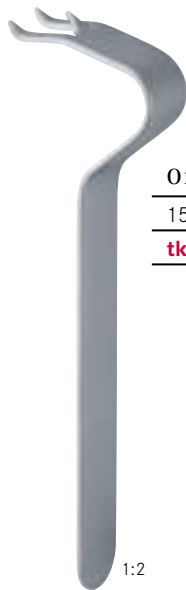

OBWEGESER
155 mm - 6"
tk 52723-16

1:2



OBWEGESER	x = 8 mm	x = 10 mm
160 mm - 6 1/4"	tk 52725-08	tk 52725-10

biegsam
malleable
 malléable
malleable
 flessibile

1:2

Wundhaken
Retractors

Ecarteurs
Separadores
Divaricatori

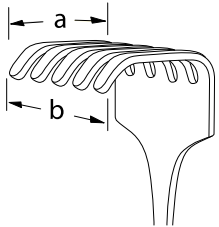

OLLIER

	a = 36 mm - b = 30 mm	a = 36 mm - b = 60 mm
225 mm - 8 ³ / ₄ "	tk 17105-03	tk 17105-04



KOCHER

	55 mm x 11 mm	40 mm x 12 mm
210 mm - 8 ¹ / ₄ "	tk 17115-21	tk 17116-21

Wundhaken
Retractors

Ecarteurs
Separadores
Divaricatori



LANGENBECK	
	60 mm x 20 mm
210 mm - 8 1/4"	tk 17117-60

1:2



LANGENBECK	
	85 mm x 15 mm
210 mm - 8 1/4"	tk 17117-85

Griff vertikal zum Blatt
Handle vertical to the blade
Poignée verticale à la lame
Mango vertical a la hoja
Manico verticale verso la lama

1:2

Wundhaken
Retractors

Ecarteurs
Separadores
Divaricatori

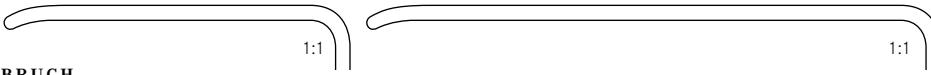

SAUERBRUCH

	45 mm x 15 mm	75 mm x 20 mm
225 mm – 8¾"	tk 17120-22	tk 17121-22

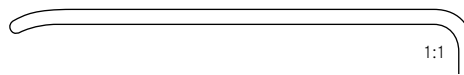

	60 mm x 23 mm
220 mm – 8¾"	tk 17122-22

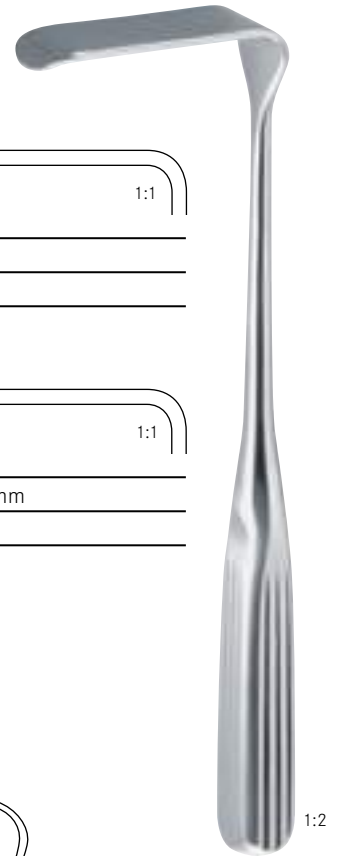

LAHEY

190 mm – 7½"
28 mm x 6 mm
tk 17118-19



KOCHER

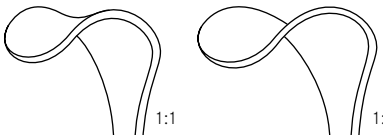

	19 mm x 12 mm	21 mm x 14 mm
190 mm – 7½"	tk 17125-01	tk 17125-02

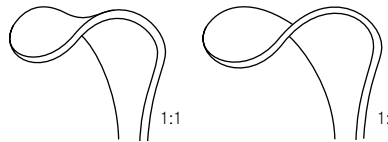

KOCHER

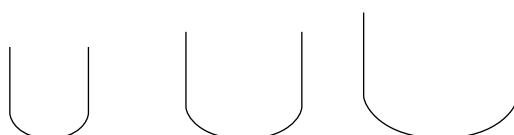

	40 mm x 10 mm	40 mm x 15 mm	40 mm x 20 mm
220 cm – 8¾"	tk 17127-01	tk 17127-02	tk 17127-03

Wundhaken | Ecarteurs
 Retractors | Separadores
 Divaricatori

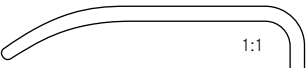
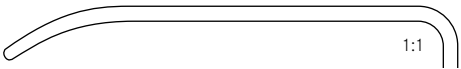

KOCHER

	 1:1	 1:1
	40 mm x 18 mm	60 mm x 20 mm
230 mm - 9"	tk 17128-18	tk 17128-20

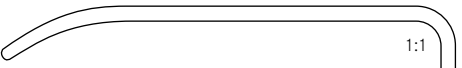
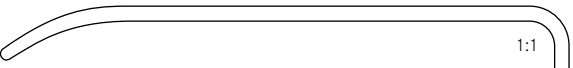
	 1:1	 1:1
	60 mm x 25 mm	75 mm x 30 mm
230 mm - 9"	tk 17128-25	tk 17128-30

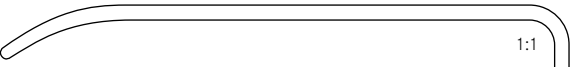
	 1:1
	75 mm x 40 mm
230 mm - 9"	tk 17128-40

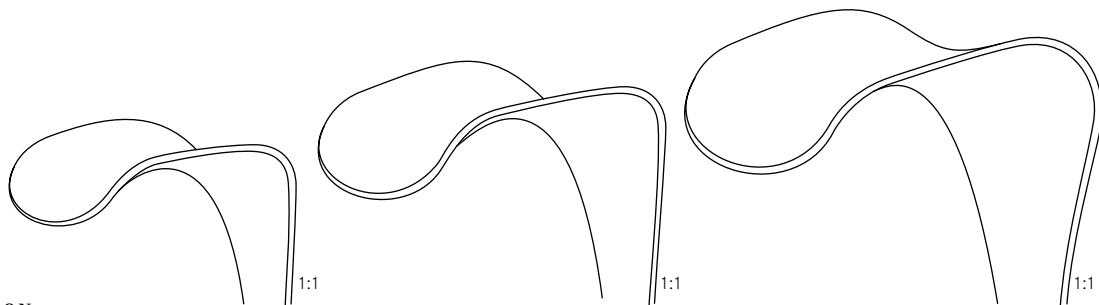

RICHARDSON

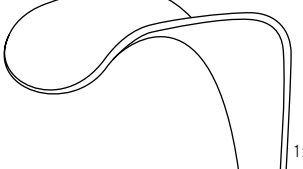
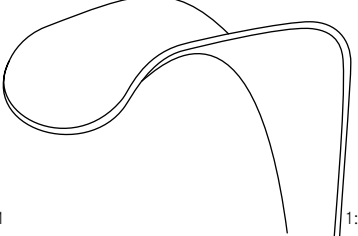
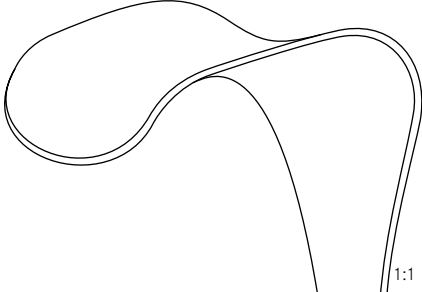
	 1:1	 1:1	 1:1
	28 mm x 20 mm	36 mm x 28 mm	44 mm x 38 mm
240 mm - 9½"	tk 17130-24	tk 17131-24	tk 17132-24

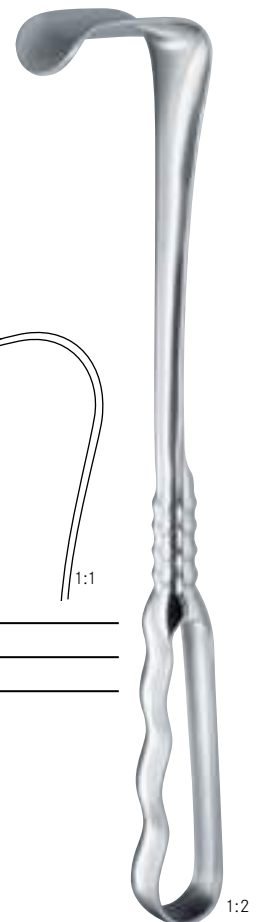

Wundhaken
Retractors

Ecarteurs
Separadores
Divaricatori



RICHARDSON-EASTMAN

	Fig. 1	Fig. 2
	280 mm - 11"	260 mm - 10 1/4"
	49 mm x 38 mm	36 mm x 28 mm
	63 mm x 49 mm	28 mm x 20 mm
tk 17135-01	x	
tk 17135-02		x
tk 17135-00	x	x

RICHARDSON

240 mm - 9 1/2"
52 mm x 22 mm
tk 17133-24

KELLY

260 mm - 10 1/4"
65 mm x 50 mm
tk 17134-26

Wundhaken | Ecarteurs
 Retractors | Separadores
 Divaricatori



HOESEL
 260 mm - 10 1/4"

1:2

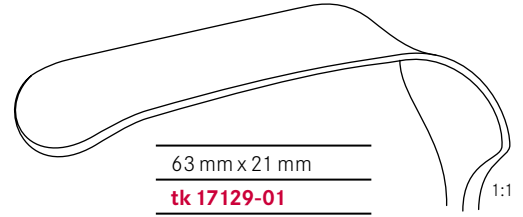

63 mm x 21 mm
tk 17129-01

1:1

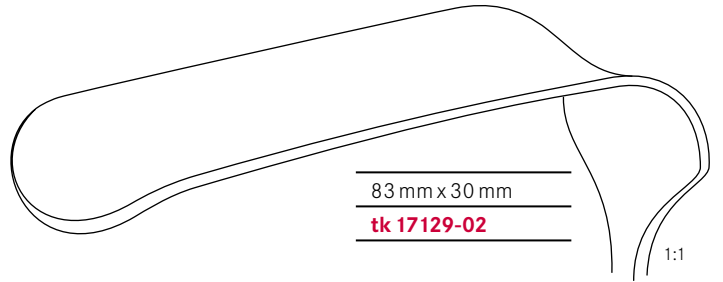

83 mm x 30 mm
tk 17129-02

1:1

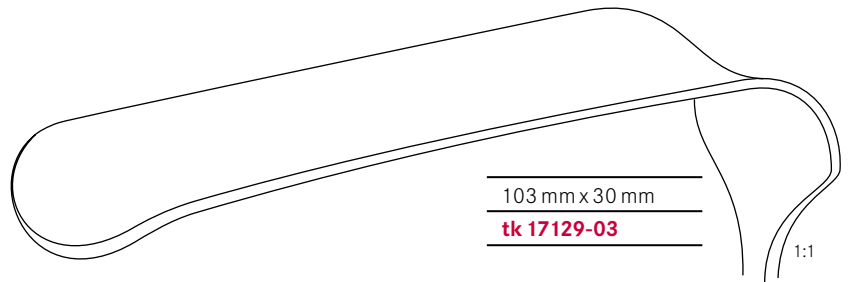

103 mm x 30 mm
tk 17129-03

1:1

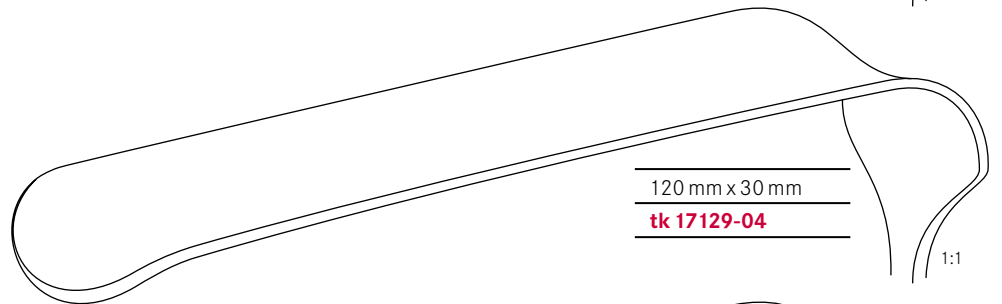

120 mm x 30 mm
tk 17129-04

1:1

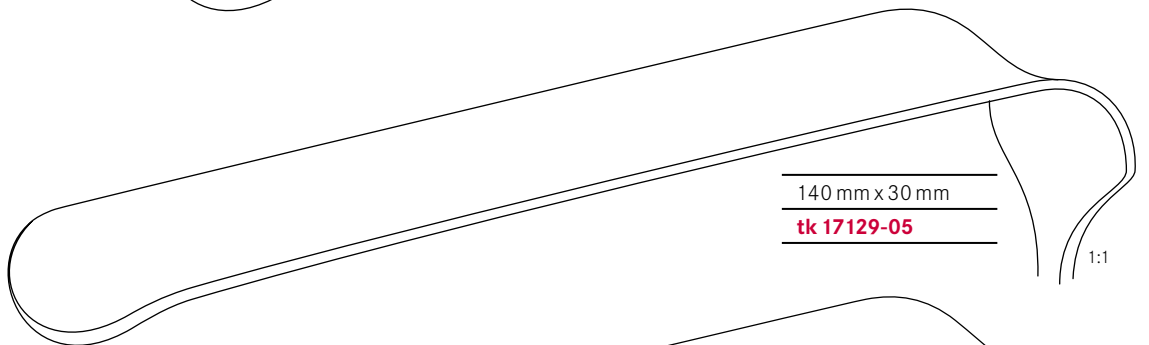

140 mm x 30 mm
tk 17129-05

1:1

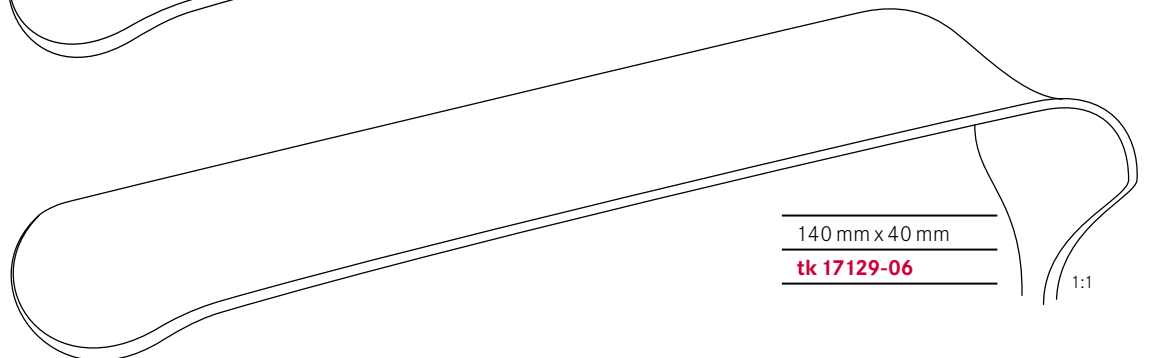

140 mm x 40 mm
tk 17129-06

1:1

Wundhaken
Retractors

Ecarteurs
Separadores
Divaricatori

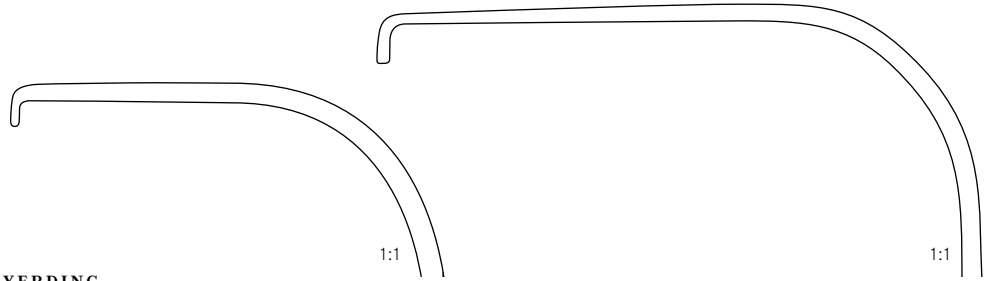

MEYERDING

200 mm – 8"	220 mm – 8¾"
50 mm x 16 mm	75 mm x 25 mm
tk 17140-20	tk 17141-22

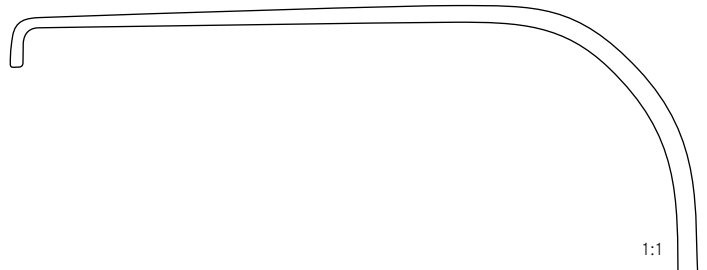

240 mm – 9½"
90 mm x 50 mm
tk 17142-24

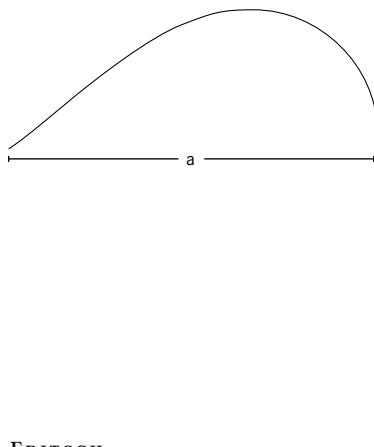

FRITSCH

235 mm – 9¼"	a = 37 mm – b = 31 mm	tk 17150-24
240 mm – 9½"	a = 38 mm – b = 40 mm	tk 17151-24
250 mm – 9¾"	a = 43 mm – b = 51 mm	tk 17152-24
250 mm – 9¾"	a = 49 mm – b = 61 mm	tk 17153-24
255 mm – 10"	a = 48 mm – b = 75 mm	tk 17154-24
265 mm – 10½"	a = 65 mm – b = 85 mm	tk 17155-24

Wundhaken
Retractors

Ecarteurs
Separadores
Divaricatori



SIMON		
	115 mm x 22 mm	115 mm x 27 mm
280 cm - 11"	tk 17160-28	tk 17161-28

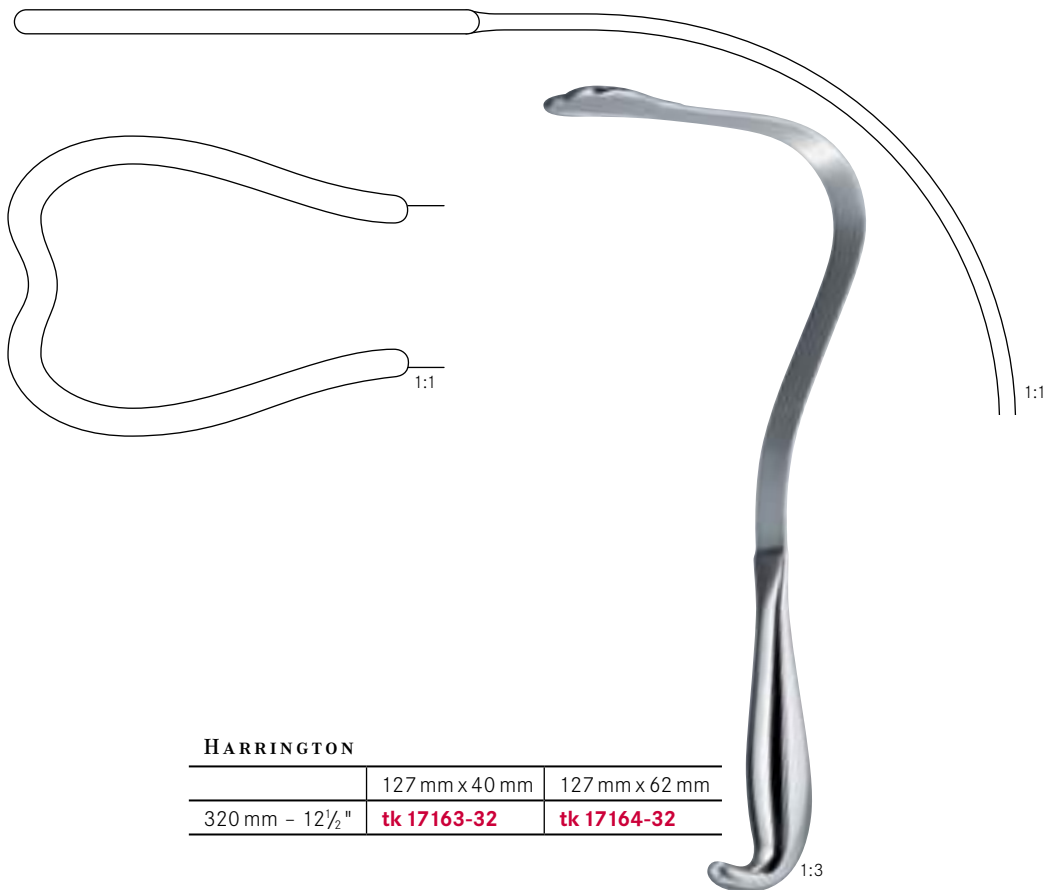

HARRINGTON		
	127 mm x 40 mm	127 mm x 62 mm
320 mm - 12½"	tk 17163-32	tk 17164-32

Wundhaken
Retractors

Ecarteurs
Separadores
Divaricatori



1:2

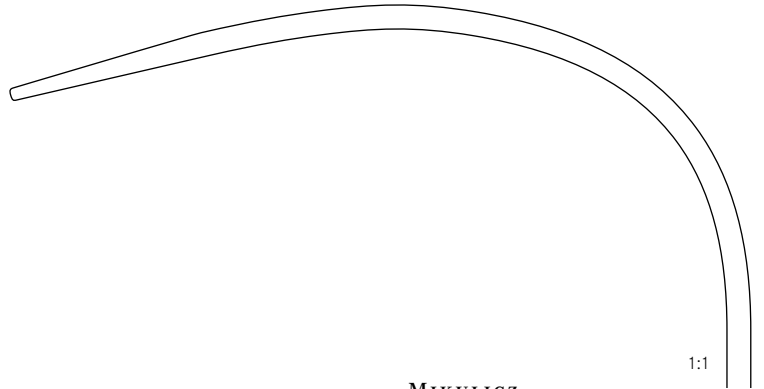

1:1

MIKULICZ

	95 mm x 35 mm
260 mm - 10 1/4"	tk 17170-26

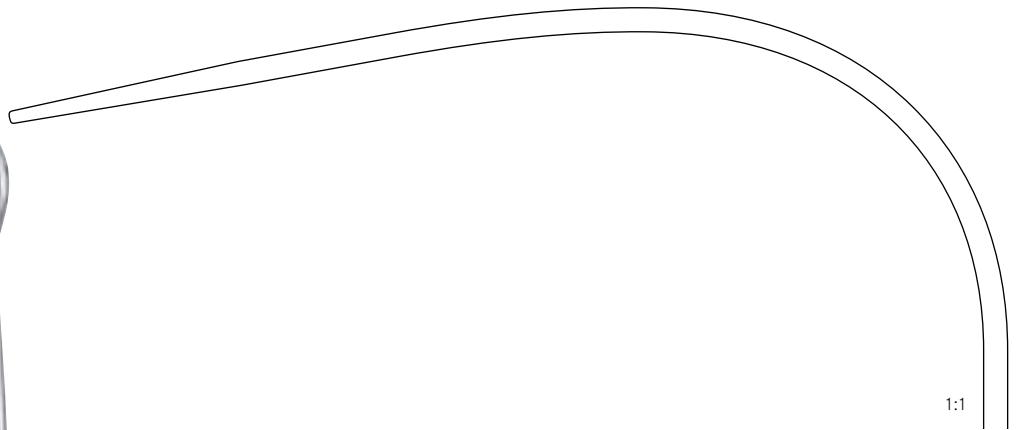

1:1

120 mm x 50 mm
tk 17171-26

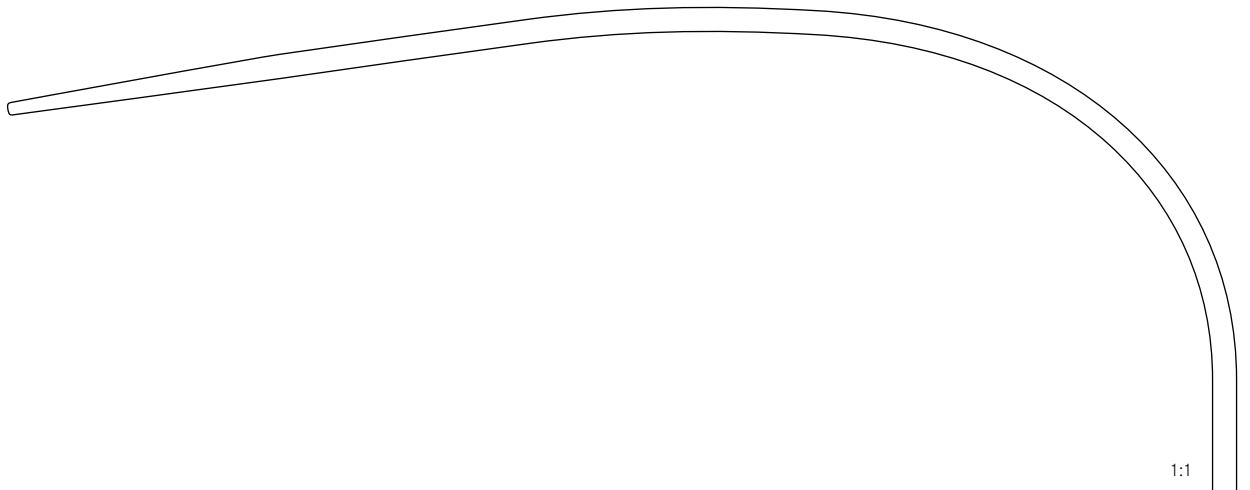

1:1

150 mm x 50 mm
tk 17172-26

Wundhaken | Ecarteurs
 Retractors | Separadores
 Divaricatori



MIKULICZ

260 mm - 10 1/4"

90 mm x 50 mm

tk 17174-26

1:2



DAVIDSON

160 mm - 6 1/4"

a = 75 mm - b = 50 mm

a = 75 mm - b = 90 mm

tk 17176-01

tk 17176-02

1:2

Wundhaken
Retractors

Ecarteurs
Separadores
Divaricatori

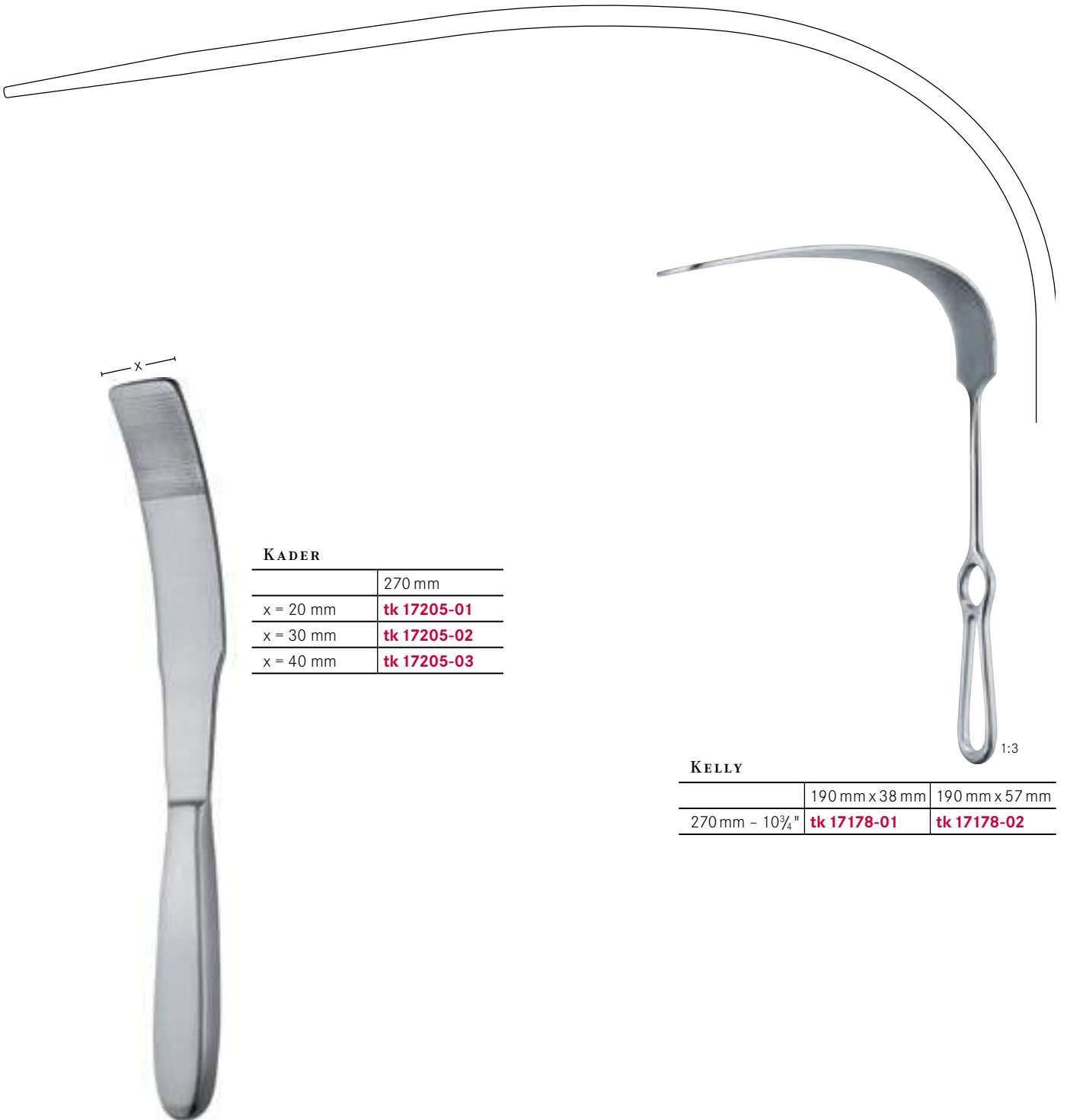

KADER

	270 mm
x = 20 mm	tk 17205-01
x = 30 mm	tk 17205-02
x = 40 mm	tk 17205-03

KELLY

	190 mm x 38 mm	190 mm x 57 mm
270 mm – 10 $\frac{3}{4}$ "	tk 17178-01	tk 17178-02

Wundhaken | Ecarteurs
 Retractors | Separadores
 Divaricatori



1:3

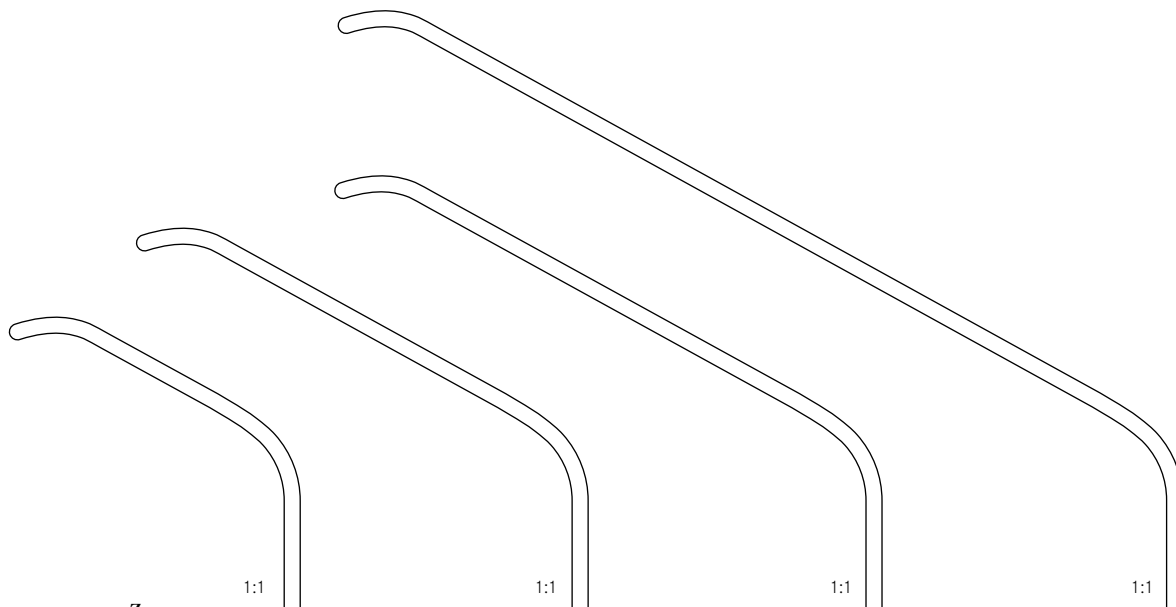

ZENKER

250 mm - 9 ³ / ₄ "	260 mm - 10 ¹ / ₄ "	275 mm - 10 ³ / ₄ "	290 mm - 11 ¹ / ₂ "
35 mm x 8 mm	60 mm x 12 mm	75 mm x 12 mm	120 mm x 12 mm
tk 17179-01	tk 17179-02	tk 17179-03	tk 17179-04

Wundhaken
Retractors

Ecarteurs
Separadores
Divaricatori

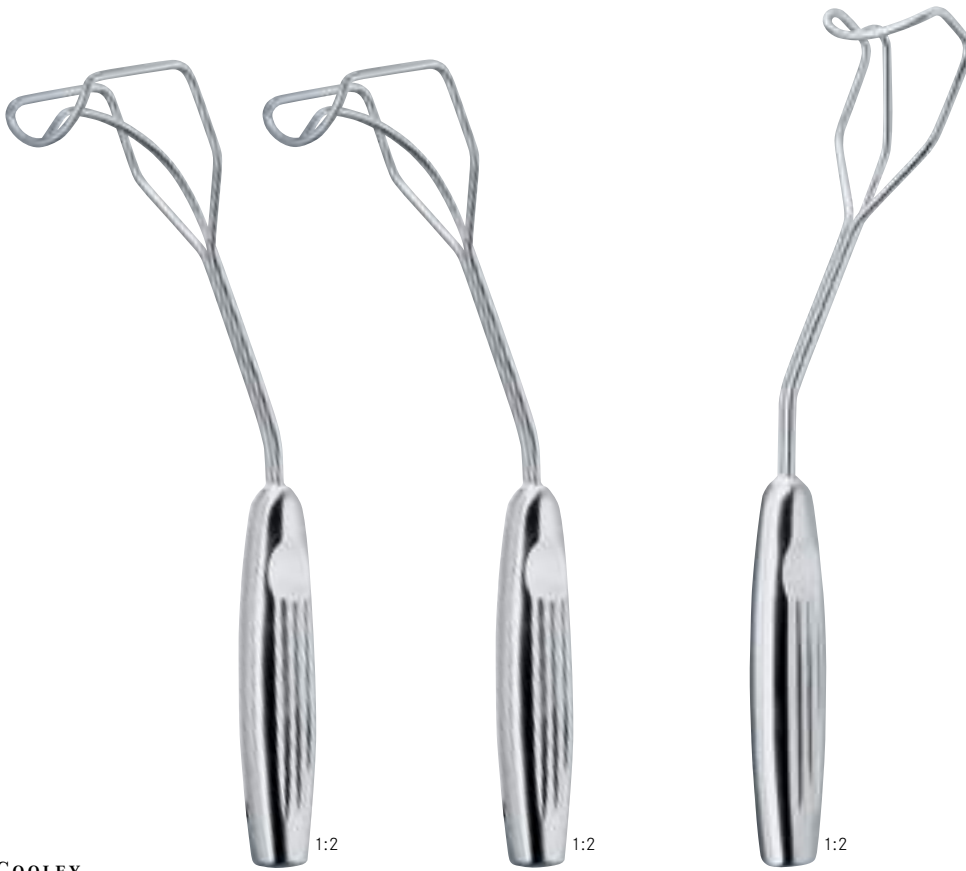

COOLEY

	250 mm – 9¾" 1:2	250 mm – 9¾" 1:2	270 mm – 10½" 1:2
	tk 17180-01	tk 17180-02	tk 17180-03
	rechts <i>right</i> droite <i>derecha</i> destra	rechts, gerieft <i>right, serrated</i> droite, strié <i>derecha, estriada</i> destra, zigrinato	links <i>left</i> gauche <i>izquierda</i> sinistra

Wundhaken | Ecarteurs
 Retractors | Separadores
 Divaricatori

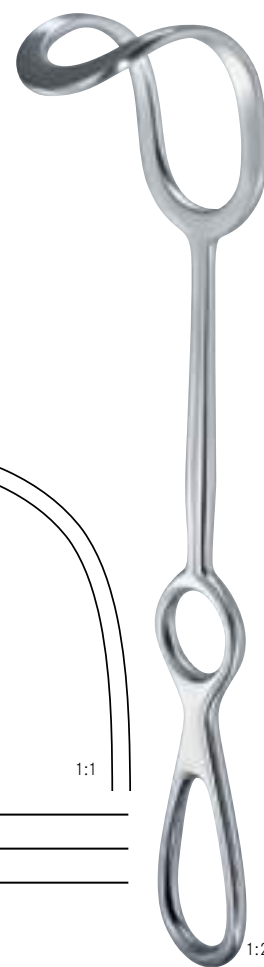
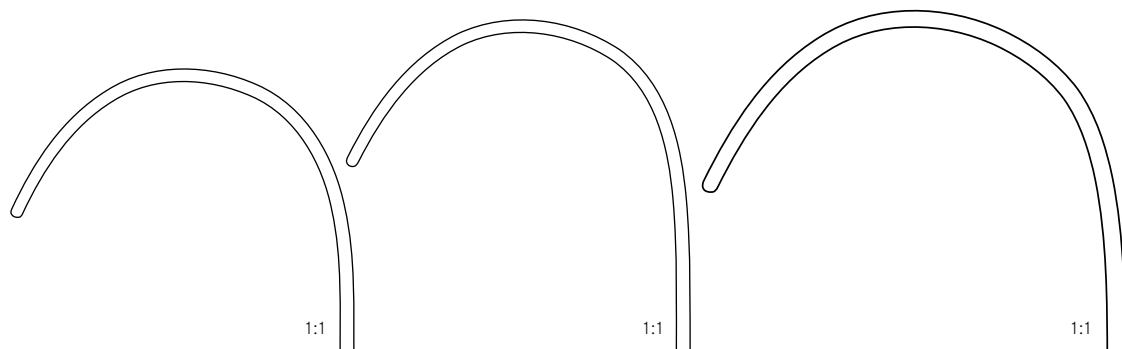

MIDDELDORPF

	45 mm x 45 mm	45 mm x 50 mm	55 mm x 70 mm
255 mm - 10"	tk 17181-01	tk 17181-02	tk 17181-03

Wundhaken
Retractors

Ecarteurs
Separadores
Divaricatori

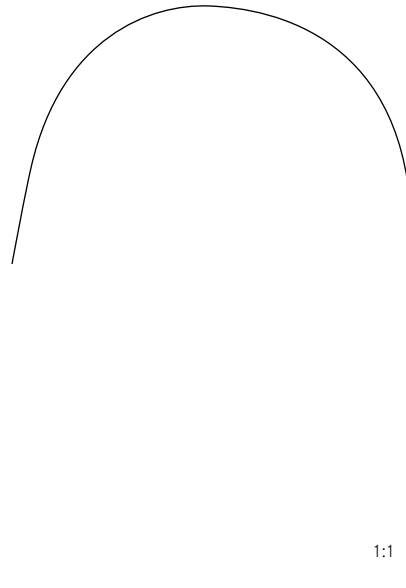

1:1

DOYEN

250 mm - 9¾"

50 mm x 85 mm

tk 17184-25

1:2

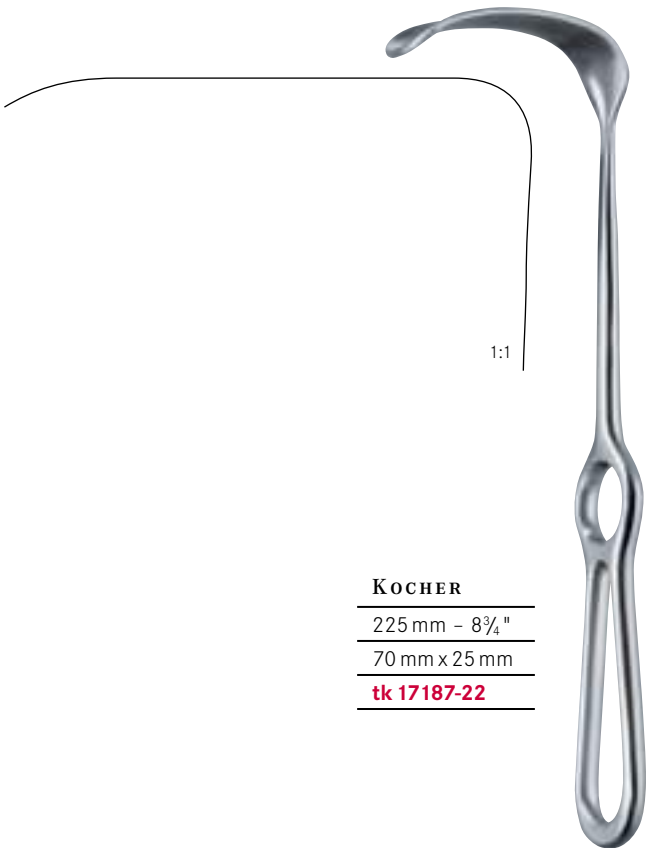
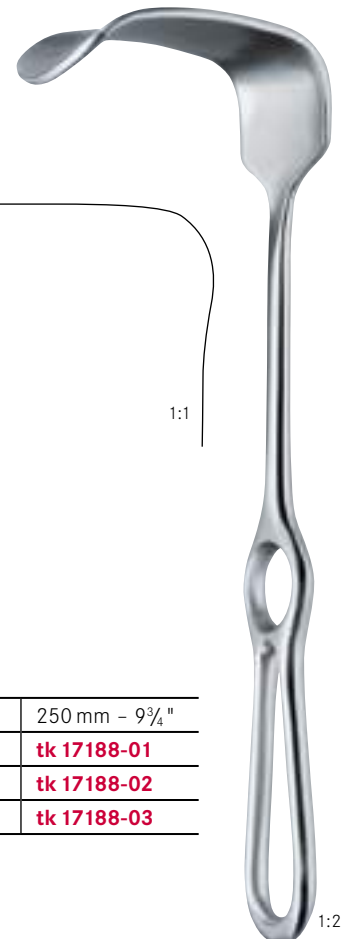

1:1

1:1

KOCHER

225 mm - 8¾"

70 mm x 25 mm

tk 17187-22

1:2

KOCHER

250 mm - 9¾"

80 mm x 45 mm

tk 17188-01

80 mm x 55 mm

tk 17188-02

80 mm x 65 mm

tk 17188-03

1:2

Wundhaken
Retractors

Ecarteurs
Separadores
Divaricatori



TUFFIER

230 mm - 9"

64 mm x 60 mm

tk 17189-23

1:3



MARTIN

250 mm - 9 3/4"

105 mm x 27 mm

tk 17192-25

1:3



SAUERBRUCH

250 mm - 9 3/4"

125 mm x 37 mm

tk 17196-25

1:3

Wundhaken
Retractors

Ecarteurs
Separadores
Divaricatori

HEANEY		1:1	1:1
	45 mm x 25 mm		73 mm x 28 mm
270 mm – 10 ³ / ₄ "	tk 17193-01		tk 17193-02

	82 mm x 28 mm	1:1
	tk 17193-03	

CORYLLOS		1:1
	82 mm x 22 mm	
240 mm – 9 ¹ / ₂ "	tk 17194-01	

	108 mm x 43 mm	1:1
	tk 17194-02	

	115 mm x 65 mm	1:1
	tk 17194-03	

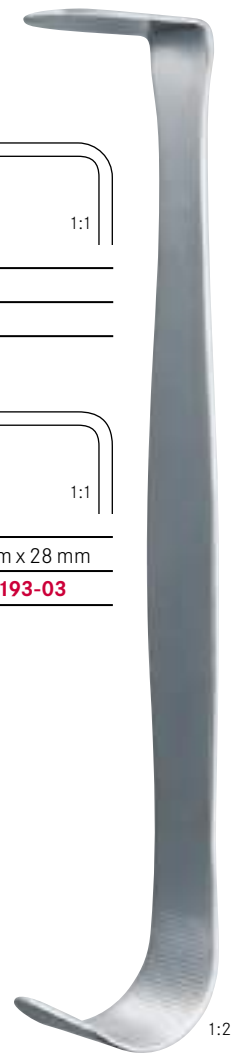

Wundhaken | Ecarteurs
 Retractors | Separadores
 Divaricatori



BRUNNER
 250 mm - 9³/₄"

1:2

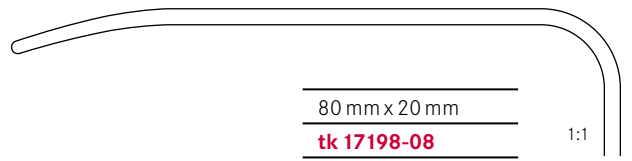

80 mm x 20 mm

tk 17198-08

1:1



100 mm x 20 mm

tk 17198-10

1:1

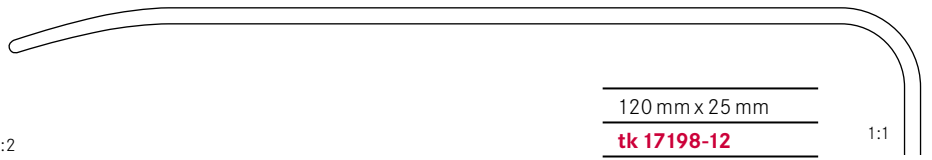

120 mm x 25 mm

tk 17198-12

1:1

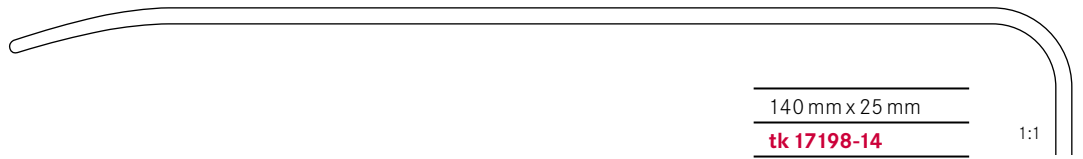

140 mm x 25 mm

tk 17198-14

1:1



160 mm x 30 mm

tk 17198-16

1:1

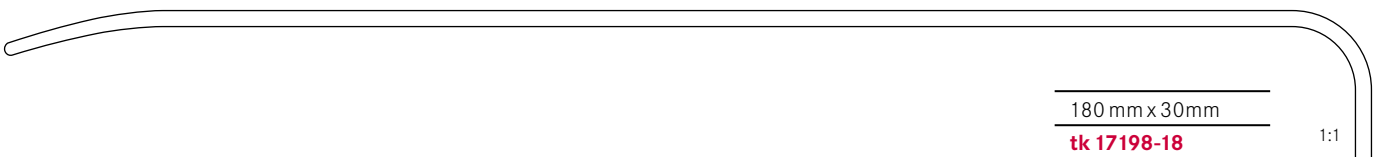

180 mm x 30 mm

tk 17198-18

1:1

Wundhaken
Retractors

Ecarteurs
Separadores
Divaricatori



BRUNNER

240 mm – 9½"

142 mm x 25 mm

tk 17197-24



Bitte fordern Sie unseren Spezialkatalog für Plastische Chirurgie an.
Please ask for our special catalogue for plastic surgery.

Veillez demander pour notre catalogue spécial pour la chirurgie plastique.
Por favor preguntan para el catalogo especial para la cirugía plástica.

Per favore domandate per il nostro catalogo speciale per la chirurgia plastica.

Brust Dissektoren
Mamaplasty retractors

Ecarteurs mammaires
Separadores mamarias
Divaricatori per seno

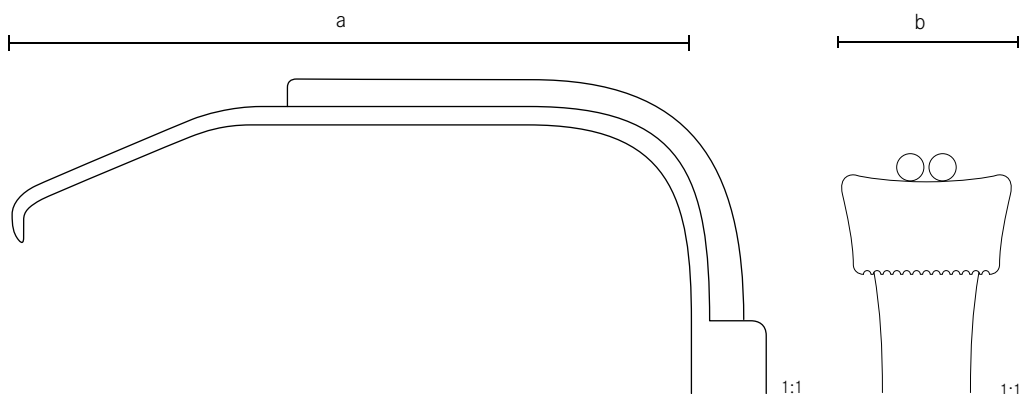

a	b	185 mm - 7/4"	185 mm - 7/4"
90 mm	24 mm	tk 17217-01	tk 17217-06
90 mm	30 mm	tk 17217-60	tk 17217-40
115 mm	24 mm	tk 17217-02	tk 17217-07
120 mm	30 mm	tk 17217-61	tk 17217-41
150 mm	25 mm	tk 17217-05	tk 17217-08
150 mm	36 mm	tk 17217-03	tk 17217-09
190 mm	30 mm	tk 17217-04	tk 17217-10

gezahnt und Kaltlichtbeleuchtung
toothed with fiber optic illumination

dentelée avec illumination à lumière froide
dentada con iluminación de luz fría
dentata con illuminazione a luce fredda

mit Spühlrohr
with irrigation tube

avec tube de lavage
con tubo lavador
con tubo di lavaggio

ohne Spülrrohr
without irrigation tube

sans tube de lavage
sin tubo lavador
senza tubo di lavaggio

a	b	185 mm - 7/4"	185 mm - 7/4"
90 mm	24 mm	tk 17217-21	tk 17217-26
115 mm	24 mm	tk 17217-22	tk 17217-27
150 mm	25 mm	tk 17217-25	tk 17217-28
150 mm	36 mm	tk 17217-23	tk 17217-29
190 mm	30 mm	tk 17217-24	tk 17217-30

ohne Zähne mit Kaltlichtbeleuchtung
non-toothed with fiber optic illumination

sans denture avec illumination à lumière froide
sin dentada con iluminación de luz fría
no dentata con illuminazione a luce fredda

mit Spühlrohr
with irrigation tube

avec tube de lavage
con tubo lavador
con tubo di lavaggio

ohne Spülrrohr
without irrigation tube

sans tube de lavage
sin tubo lavador
senza tubo di lavaggio

Brust Dissektoren
Mamaplasty retractors

Ecarteurs mammaires
Separadores mamarias
Divaricatori per seno



1:2

FERREIRA

a	b	185 mm - 7/4"	
90 mm	24 mm	tk 17219-01	tk 17219-06
115 mm	24 mm	tk 17219-02	tk 17219-07
150 mm	25 mm	tk 17219-03	tk 17219-08
150 mm	36 mm	tk 17219-04	tk 17219-09
190 mm	30 mm	tk 17219-05	tk 17219-10

**MACCOLLUM -
DINGMAN**

315 mm - 12 1/2"

tk 16903-30

Wundhaken
Retractors

Ecarteurs
Retradores
Divaricatori

ohne Zahnung
non-toothed

sans denture
sin dentada
no dentata

Gezahnt
toothed

denture
dentada
dentata

Brust Dissektoren
Mamaplasty retractors

Ecarteurs mammaires
Separadores mamarias
Divaricatori per seno



330 mm - 13"	tk 17156-08	tk 17156-10	tk 17156-12
420 mm - 16½"	tk 17156-09	tk 17156-11	tk 17156-13
abgewinkelt <i>angled</i>	starr <i>rigid</i>	biegsam <i>malleable</i>	Schaft isoliert <i>Shaft insulated</i>
angulé <i>angulado</i> angolato	rigide <i>rigido</i>	maléable <i>maleable</i> flessibile	Tige isolée <i>Tija aislada</i> Asta isolata



330 mm - 13"	tk 17156-01	tk 17156-03	tk 17156-05
420 mm - 16½"	tk 17156-02	tk 17156-04	tk 17156-06
	starr <i>rigid</i>	biegsam <i>malleable</i>	Schaft isoliert <i>Shaft insulated</i>
	rigide <i>rigido</i> rigido	maléable <i>maleable</i> flessibile	Tige isolée <i>Tija aislada</i> Asta isolata



	x = 25 mm	x = 33 mm
315 mm - 12½"	tk 17156-20	tk 17156-21

halbstarr
semi rigid
semi rigide
semi rigido
semi rigido

Wundhaken
Retractors

Ecarteurs
Separadores
Divaricatori

x



GIL-VERNET

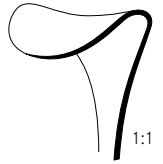
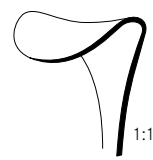

	x = 8 mm	x = 11 mm	x = 15 mm	x = 17 mm	x = 20 mm	x = 23 mm
240 mm - 9½"	tk 17203-08	tk 17203-11	tk 17203-15	tk 17203-17	tk 17203-20	tk 17203-23

biegsam
malleable
malléable
maleable
malleabile

1:2



ST. MARKS

290 mm - 11½"	325 mm - 12¾"	330 mm - 13"
130 mm x 60 mm	180 mm x 60 mm	180 mm x 60 mm
tk 17214-01	tk 17214-02	tk 17214-03

Wundhaken
Retractors

Ecarteurs
Separadores
Divaricatori

CUSHING

200 mm - 8"

tk 17204-20



KOERTE

280 mm - 11"

120 mm x 47 mm

tk 17212-28

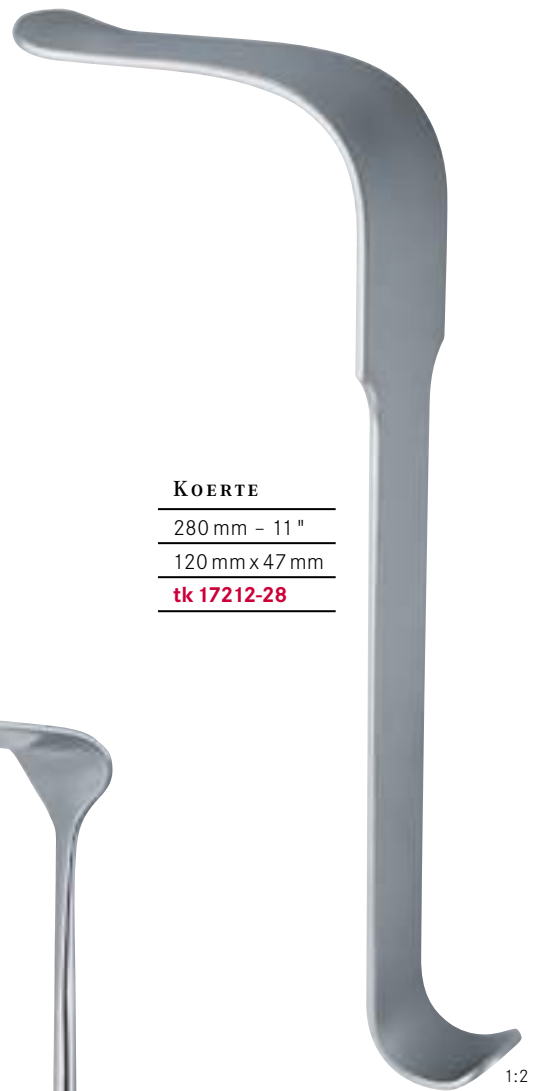

MORRIS

210 mm - 8 1/4"

50 mm x 55 mm

tk 17215-21



MORRIS

	70 mm x 40 mm	70 mm x 50 mm	70 mm x 65 mm
245 mm - 9 3/4"	tk 17900-40	tk 17900-50	tk 17900-65

Wundhaken
Retractors

Ecarteurs
Separadores
Divaricatori



DEAVER

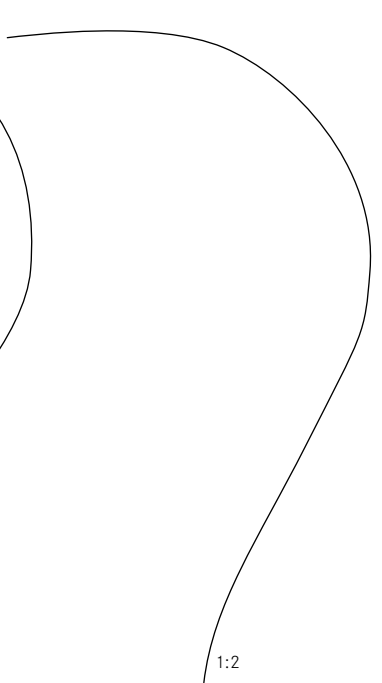
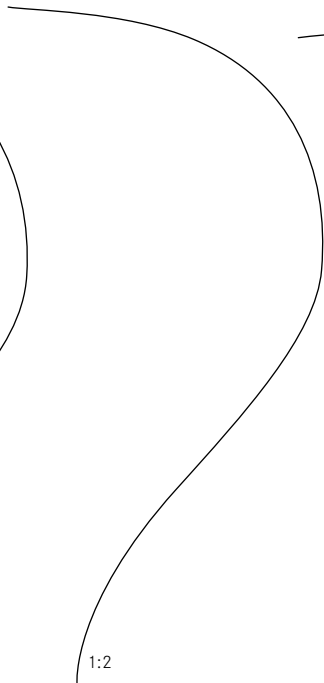
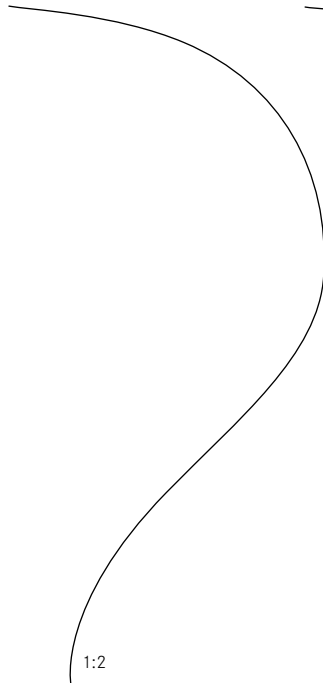

	x = 25 mm	x = 38 mm	x = 50 mm
315 mm - 12½"	tk 17285-25	tk 17285-38	tk 17285-50

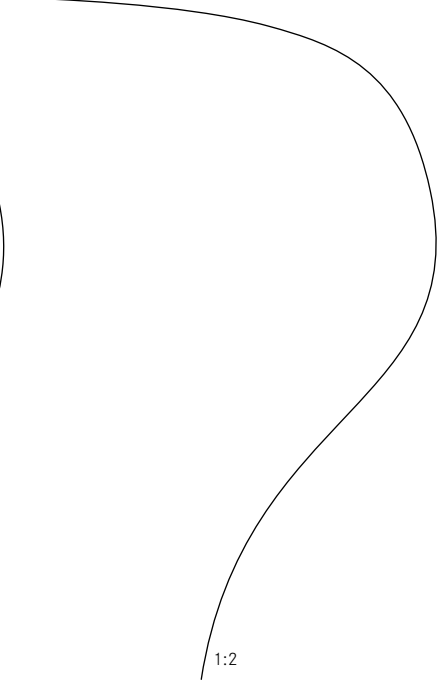
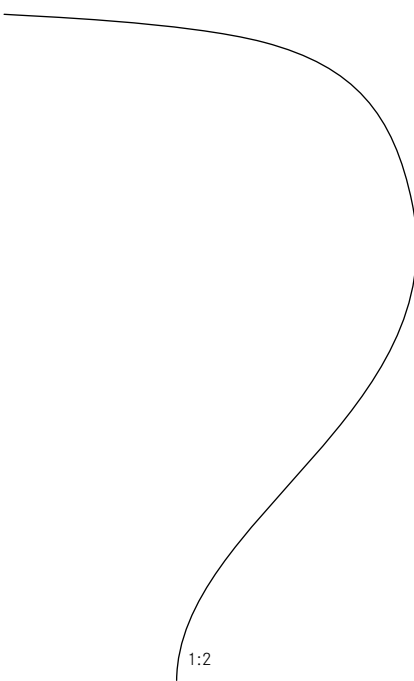

x = 75 mm	x = 100 mm
tk 17285-75	tk 17286-10

Wundhaken | Ecarteurs
 Retractors | Separadores
 Divaricatori



DEAVER		
180 mm - 7"	215 mm - 8½"	230 mm - 9"
x = 19 mm	x = 22 mm	x = 25 mm
tk 17219-18	tk 17222-21	tk 17225-23

Wundhaken
Retractors

Ecarteurs
Separadores
Divaricatori



DEAVER

300 mm - 12"	330 mm - 13"	360 mm - 14 $\frac{1}{4}$ "
x = 25 mm	x = 25 mm	x = 25 mm
tk 17225-30	tk 17225-33	tk 17225-36

Wundhaken | Ecarteurs
 Retractors | Separadores
 Divaricatori



DEAVER

300 mm - 12"	300 mm - 12"	300 mm - 12"
x = 38 mm	x = 50 mm	x = 75 mm
tk 17238-30	tk 17250-30	tk 17275-30

Wundhaken
Retractors

Ecarteurs
Separadores
Divaricatori

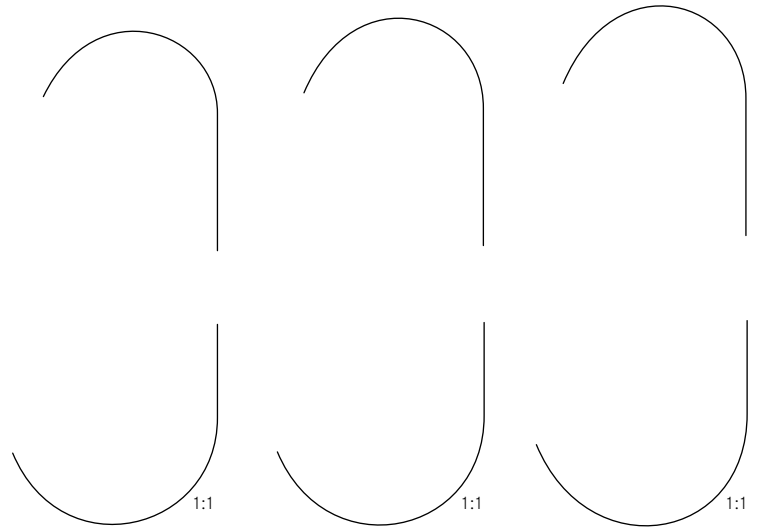

Roux

	Fig. 1	Fig. 2	Fig. 3
	140 mm - 5½"	150 mm - 6"	170 mm - 6¾"
	24 mm x 20 mm	29 mm x 26 mm	33 mm x 29 mm
	30 mm x 28 mm	36 mm x 36 mm	38 mm x 43 mm
	tk 17301-14	tk 17302-15	tk 17303-17
tk 17300-00	x	x	x

Satz
Set
Jeu
Juego
Serie

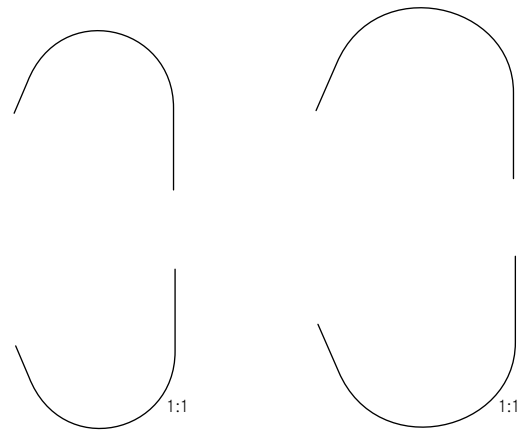

PARKER

	Fig. 1	Fig. 2
	135 mm - 5¼"	135 mm - 5¼"
	18 mm x 15 mm	22 mm x 15 mm
tk 17305-00	x	x

Satz
Set
Jeu
Juego
Serie

Wundhaken | Ecarteurs
 Retractors | Separadores
 Divaricatori



1:2

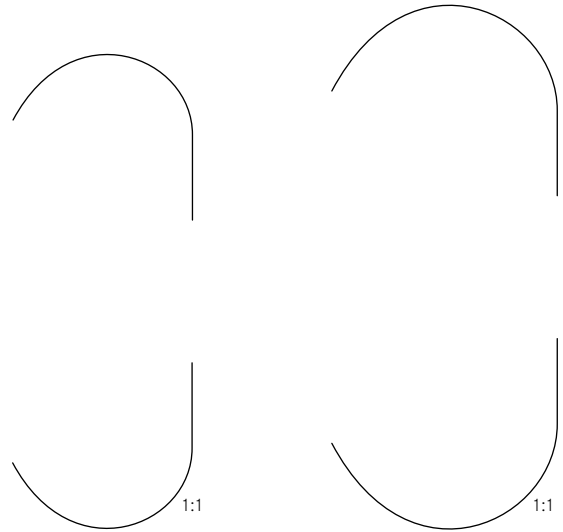

1:1

1:1

PARKER

180 mm - 7"	Fig. 1	Fig. 2
	26 mm x 25 mm	29 mm x 25 mm
	27 mm x 25 mm	27 mm x 25 mm
tk 17305-18	x	x

Satz
 Set
 Jeu
 Juego
 Serie



1:2

MINI-ROUX

145 mm - 5 ³ / ₄ "
8 mm x 6 mm
tk 17306-01

1:1

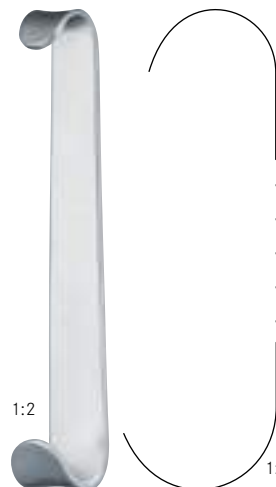

1:2

BABY-ROUX

130 mm - 5"
17 mm x 16 mm
18 mm x 22 mm
tk 17306-02

1:1

Wundhaken
Retractors

Ecarteurs
Separadores
Divaricatori



1:2

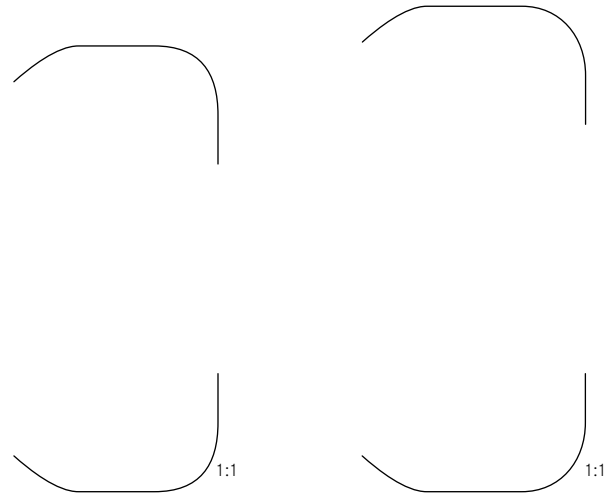

MAYO-COLLIN

150 mm - 6"	Fig. 1	Fig. 2
	25 mm x 18 mm	28 mm x 19 mm
	28 mm x 18 mm	32 mm x 19 mm
tk 17307-00	x	x

Satz
Set
Jeu
Juego
Serie



1:2

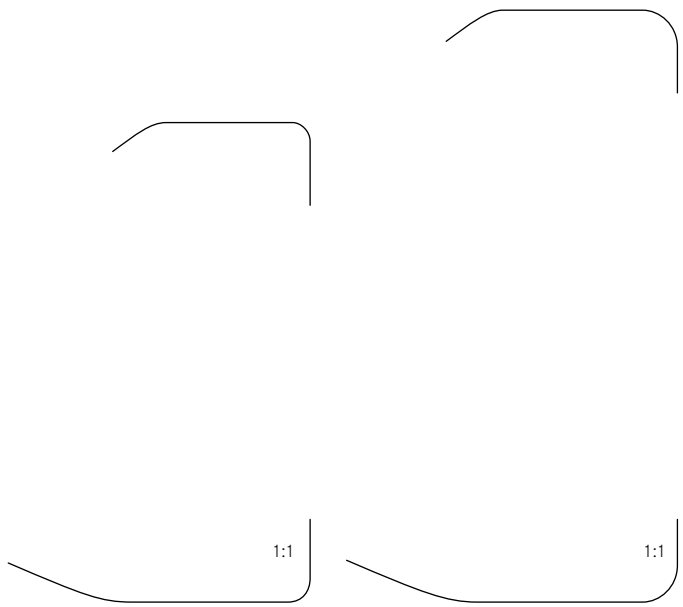

PARKER-LANGENBECK
(US ARMY)

210 mm - 8 1/4"	Fig. 1	Fig. 2
	21 mm x 24 mm	25 mm x 24 mm
	40 mm x 15 mm	45 mm x 15 mm
tk 17309-00	x	x

Satz
Set
Jeu
Juego
Serie

Wundhaken | Ecarteurs
 Retractors | Separadores
 Divaricatori



MATHIEU

200 mm - 8"	Fig. 1	Fig. 2
	42 mm x 13 mm	47 mm x 13 mm
	42 mm x 26 mm	46 mm x 26 mm
tk 17310-00	x	x

Satz
 Set
 Jeu
 Juego
 Serie

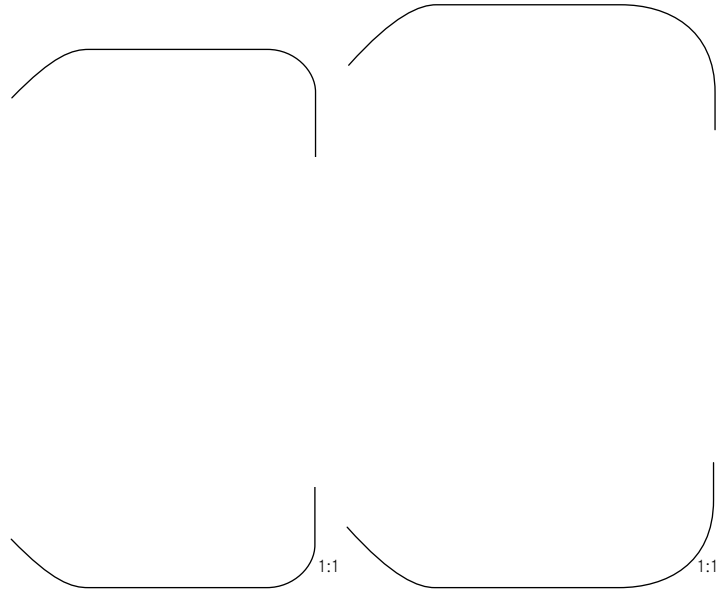

LANE

230 mm - 9"
35 mm x 19 mm
30 mm x 13 mm
tk 17299-01

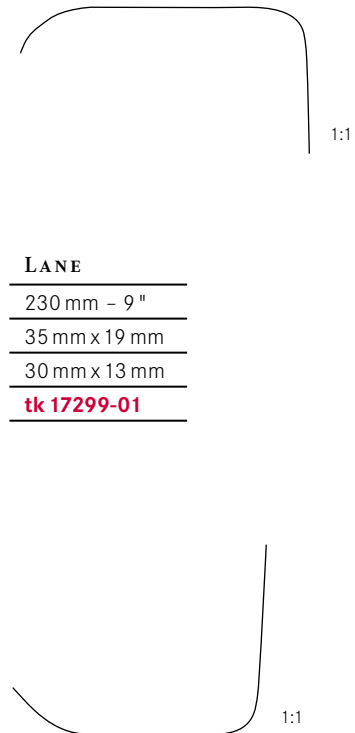

Wundhaken
Retractors

Ecarteurs
Separadores
Divaricatori

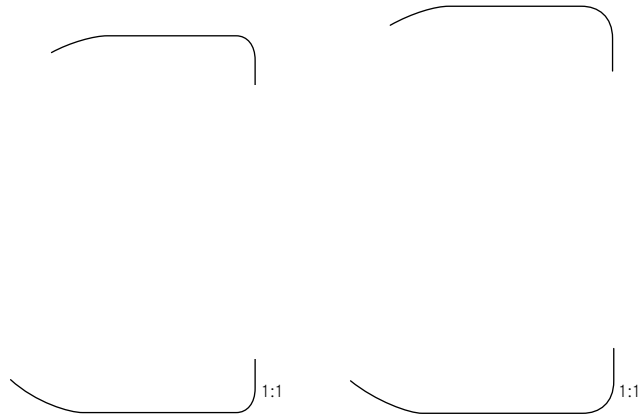

FARABEUF

120 mm – 4¾"	Fig. 1	Fig. 2
	26 mm x 10 mm	30 mm x 10 mm
	30 mm x 12 mm	34 mm x 12 mm
tk 17311-12	x	x

Satz

Set

Jeu

Juego

Serie

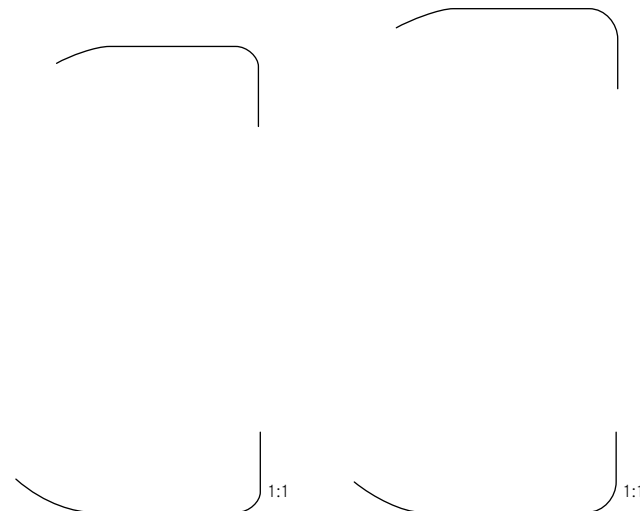

FARABEUF

150 mm – 6"	Fig. 1	Fig. 2
	23 mm x 16 mm	27 mm x 16 mm
	26 mm x 16 mm	30 mm x 16 mm
tk 17312-15	x	x

Satz

Set

Jeu

Juego

Serie

Wundsperrer
Self-retaining retractors

Ecarteurs autostatiques
Separadores autoestáticos
Divaricatori autostatici



ALM

70 mm - 2 3/4"	tk 17330-07	tk 17330-17	tk 17331-07
100 mm - 4"	tk 17330-10	tk 17330-20	tk 17331-10

scharf <i>sharp</i>	halbscharf <i>semi sharp</i>	stumpf <i>blunt</i>
pointu <i>agudo</i>	semi pointu <i>semi agudo</i>	mousse <i>romo</i>
acuto	semi acuto	smusso



1:2

HOLTZHEIMER

100 mm - 4"	tk 17336-10	tk 17337-10
-------------	--------------------	--------------------

scharf <i>sharp</i>	stumpf <i>blunt</i>
pointu <i>agudo</i>	mousse <i>romo</i>
acuto	smusso



1:2

BOSE

70 mm - 2 3/4"

tk 17395-07



JANSEN

100 mm - 4"	tk 17480-01	tk 17480-02
-------------	--------------------	--------------------

scharf <i>sharp</i>	stumpf <i>blunt</i>
pointu <i>agudo</i>	mousse <i>romo</i>
acuto	smusso

Wundsperrer
Self-retaining retractors

Ecarteurs automatiques
Separadores autoestáticos
Divaricatori autostatici



CLOWARD-CONTOUR

140 mm - 5½"	tk 17406-01	tk 17406-02
3x4	scharf	stumpf
	sharp	blunt
	pointu	mousse
	agudo	romo
	acuto	smusso



WULLSTEIN

100 mm - 4"	tk 17408-01	tk 17408-02
3x3	scharf	stumpf
	sharp	blunt
	pointu	mousse
	agudo	romo
	acuto	smusso



WEITLANER-WULLSTEIN

130 m - 5"	tk 17408-13	tk 17408-14
3x3	scharf	stumpf
	sharp	blunt
	pointu	mousse
	agudo	romo
	acuto	smusso



MILLIGAN

130 mm - 5"	tk 17409-13
3x3	stumpf
	blunt
	mousse
	romo
	smusso

Wundsperrer
Self-retaining retractors

Ecarteurs autostatiques
Separadores autoestáticos
Divaricatori autostatici



BELUCCI

110 mm - 4 1/4 "	tk 17410-11	tk 17411-11
130 mm - 5 "	tk 17410-13	tk 17411-13

1x2
links, stumpf
left, blunt
gauche, mousse
izquierda, romo
sinistra, smusso

1x2
rechts, stumpf
right, blunt
droit, mousse
derecha, romo
destra, smusso

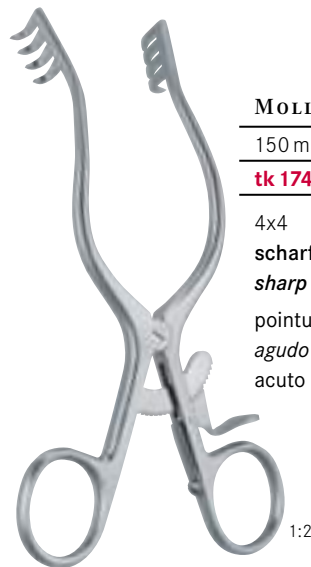

MOLLISON

150 mm - 6 "

tk 17419-15

4x4
scharf
sharp
pointu
agudo
acuto

1:2

Wundsperrer
Self-retaining retractors

Ecarteurs autostatiques
Separadores autoestáticos
Divaricatori autostatici



PLESTER

130 mm – 5"	tk 17450-13	tk 17451-13
	2x2 stumpf <i>blunt</i>	2x2 scharf <i>sharp</i>
	mousse <i>romo</i> smusso	pointu <i>agudo</i> acuto



PLESTER

110 mm – 4¼"	tk 17452-11	tk 17453-11
	2x1 links, stumpf <i>left, blunt</i>	1x2 rechts, stumpf <i>right, blunt</i>
	gauche, mousse <i>izquierda, romo</i> sinistra, smusso	droit, mousse <i>derecha, romo</i> destra, smusso

Wundsperrer
Self-retaining retractors

Ecarteurs autostatiques
Separadores autoestáticos
Divaricatori autostatici

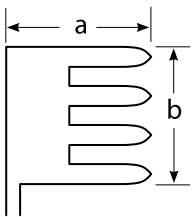

WEITLANER-LOKTITE

105 mm - 4 1/4"	a = 17 mm - b = 13 mm	tk 17400-10	tk 17400-20	tk 17401-10			
130 mm - 5"	a = 17 mm - b = 17 mm				tk 17402-13	tk 17402-23	tk 17403-13
165 mm - 6 1/2"	a = 17 mm - b = 17 mm				tk 17402-16	tk 17402-26	tk 17403-16
200 mm - 8"	a = 20 mm - b = 19 mm				tk 17404-20	tk 17404-30	tk 17405-20
260 mm - 10 1/4"	a = 26 mm - b = 21 mm				tk 17404-26	tk 17404-36	tk 17405-26

2x3
scharf
sharp
pointu
agudo
acuto

2x3
halbscharf
semi sharp
semi pointu
semi agudo
semi acuto

2x3
stumpf
blunt
mousse
romo
smusso

3x4
scharf
sharp
pointu
agudo
acuto

3x4
halbscharf
semi sharp
semi pointu
semi agudo
semi acuto

3x4
stumpf
blunt
mousse
romo
smusso

Wundsperrer
Self-retaining retractors

Ecarteurs autostatiques
Separadores autoestáticos
Divaricatori autostatici

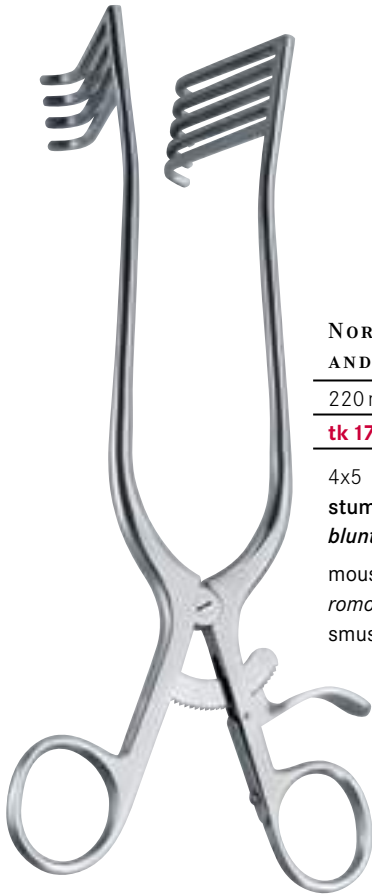

**NORFOLK
AND NORWICH**

220 mm – 8¾"

tk 17413-22

4x5
stumpf
blunt
mousse
romo
smusso

1:2



TRAVES

215 mm – 8½"

tk 17412-20

4x5
stumpf
blunt
mousse
romo
smusso

1:2



ANDERSON-ADSON

195 mm – 7¾"

tk 17417-19

tk 17418-19

4x4
scharf
sharp
pointu
agudo
acuto

4x4
stumpf
blunt
mousse
romo
smusso

1:2



MAYO-ADAMS

165 mm – 6½"

tk 17420-16

2x2
stumpf
blunt
mousse
romo
smusso

1:2

Wundsperrer
Self-retaining retractors

Ecarteurs autostatiques
Separadores autoestáticos
Divaricatori autostatici

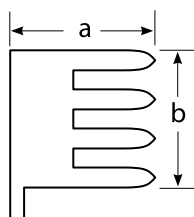

ADSON (CONE)

130 mm - 5"	a = 17 mm - b = 19 mm	tk 17423-13	tk 17424-13
160 mm - 6 1/4"	a = 17 mm - b = 19 mm	tk 17423-16	tk 17424-16
200 mm - 8"	a = 20 mm - b = 20 mm	tk 17423-20	tk 17424-20
260 mm - 10 1/4"	a = 26 mm - b = 21 mm	tk 17423-26	tk 17424-26

3x4
scharf
sharp
pointu
agudo
acuto

3x4
stumpf
blunt
mousse
romo
smusso



BECKMANN-EATON

320 mm - 12 1/2"
tk 17425-32

7x7
scharf
sharp
pointu
agudo
acuto

1:2

Wundsperrer
Self-retaining retractors

Ecarteurs autostatiques
Separadores autoestáticos
Divaricatori autostatici

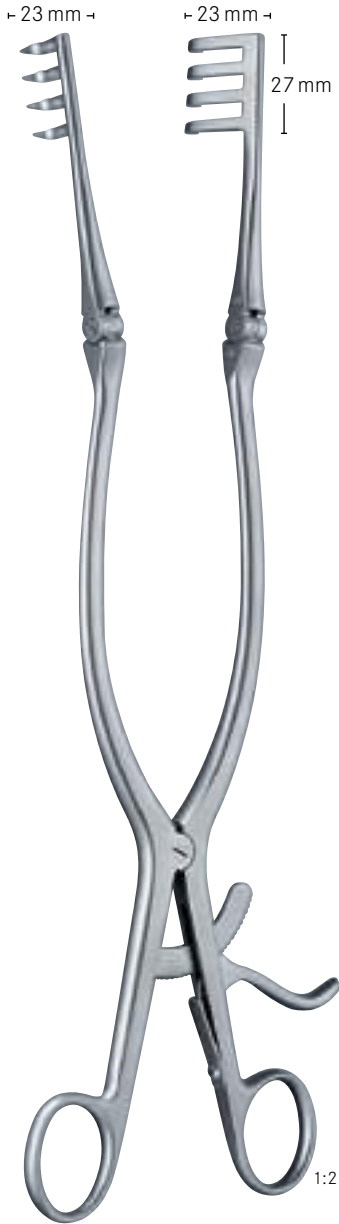

BECKMANN

310 mm - 12 $\frac{1}{4}$ "	tk 17427-31	tk 17427-41	tk 17428-31
4x4	4x4	4x4	4x4
scharf sharp	halbscharf semi sharp	halbscharf semi sharp	stumpf blunt
pointu agudo	semi pointu semi agudo	semi pointu semi agudo	mousse romo
acuto	semi acuto	semi acuto	smusso

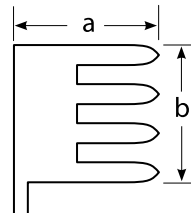

ADSON

		265 mm - 10 $\frac{1}{2}$ "	265 mm - 10 $\frac{1}{2}$ "
3x4	a = 24 mm - b = 24 mm	tk 17432-26	tk 17433-26
6x6	a = 40 mm - b = 40 mm	tk 17438-26	tk 17439-26
		scharf sharp	stumpf blunt
		pointu agudo	mousse romo
		acuto	smusso

Wundsperrer
Self-retaining retractors

Ecarteurs autostatiques
Separadores autoestáticos
Divaricatori autostatici

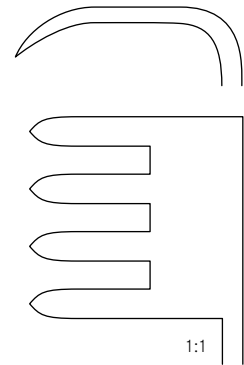
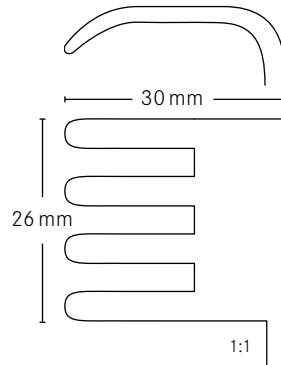
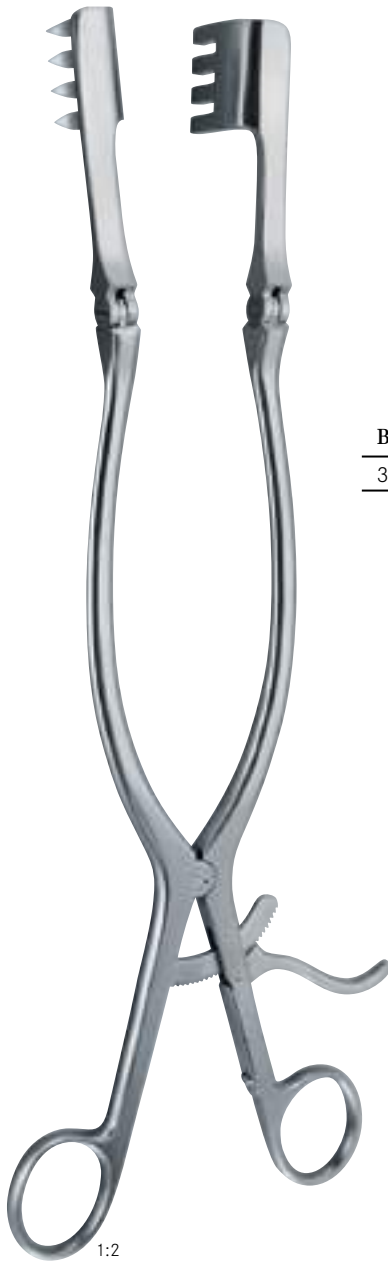

BECKMANN-ADSON

310 mm - 12 1/4"

tk 17441-00

tk 17441-01

stumpf
blunt

mousse
romo
smusso

scharf
sharp

pointu
agudo
acuto

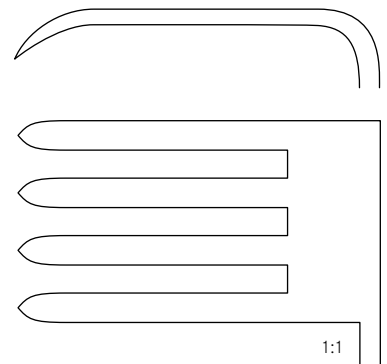
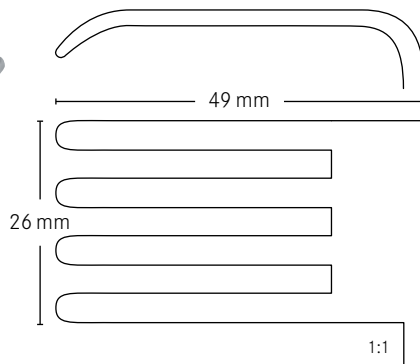

tk 17443-00

tk 17443-01

stumpf, mit tiefen Blättern
blunt, with deep blades

mousse, avec lames profondes
romo, con palas profundas
smusso, con valve profonda

scharf, mit tiefen Blättern
sharp, with deep blades

pointu, avec lames profondes
agudo, con palas profundas
acuto, con valve profonda

Wundsperrer
Self-retaining retractors

Ecarteurs autostatiques
Separadores autoestáticos
Divaricatori autostatici



GELPI-LOKTITE

90 mm – 3½"	tk 17470-09	
110 mm – 4¼"	tk 17470-11	
130 mm – 5"	tk 17470-13	
180 mm – 7"	tk 17470-18	tk 17471-18

MARKHAM-MEYERDING

180 mm – 7"	tk 17476-18	tk 17477-18
-------------	--------------------	--------------------

rechts
right

droit
derecha
destra

links
left

gauche
izquierda
sinistra



RIGBY

180 mm – 7"	tk 17490-18
-------------	--------------------

Wundsperrer
Self-retaining retractors

Ecarteurs autostatiques
Separadores autoestáticos
Divaricatori autostatici



HENLEY

165 mm - 6 1/2"	tk 17414-01	tk 17414-02
-----------------	--------------------	--------------------

3x4

scharf
sharp

pointu
agudo
acuto

3x4

stumpf
blunt

mousse
romo
smusso

komplett mit 3 Mittelvalven
complete with 3 center blades
complet avec 3 valves centrales
completa con 3 valvas centrales
completo con 3 valve centrali



19 mm x 16 mm	25 mm x 16 mm	32 mm x 16 mm
tk 17472-19	tk 17472-25	tk 17472-32

Mittelvalven
Center blades
Valves centrales
Valvas centrales
Valve centrali

Bauchdeckenhalter | Ecarteurs abdominaux
 Abdominal retractors | Separadores abdominales
 Divaricatori addominali

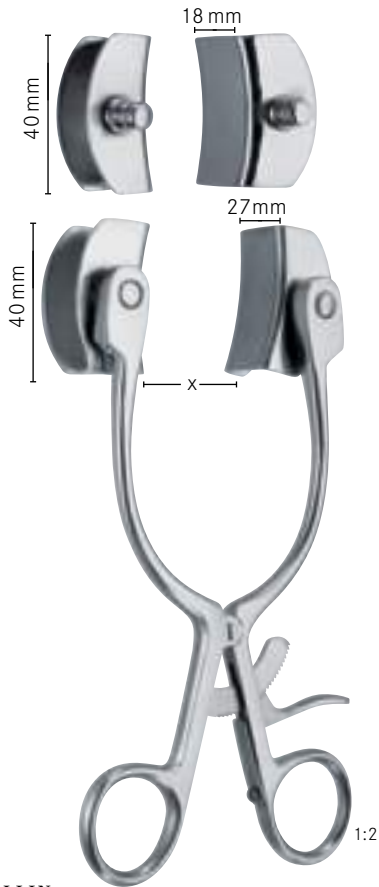

BABY-COLLIN

180 mm – 7"		
x = 80 mm		
tk 17500-00	40 mm x 18 mm	40 mm x 27 mm

komplett mit 2 Paar Valven
complete with 2 pairs of blades
 complet avec 2 paires de valves
completo con 2 pares de valvas
 completo con 2 paia di valve



COLLIN

220 mm – 8¾"		
x = 100 mm		
tk 17500-22		

COLLIN

225 mm – 8¾"		
x = 100 mm		
tk 17501-22	a = 38 mm – b = 60 mm	a = 38 mm – b = 55 mm
tk 17502-22	a = 38 mm – b = 80 mm	a = 50 mm – b = 75 mm
tk 17503-22	a = 37 mm – b = 98 mm	a = 53 mm – b = 76 mm

komplett mit
complete with
 complet avec
completo con
 completo con

Seitenvalven
Lateral blades
 Valves latérales
Valvas laterales
 Valve laterali

Mittelvalve
Center blade
 Valve centrale
Valva centrale
 Valva centrale



Bauchdeckenhalter
Abdominal retractors

Ecarteurs abdominaux
Separadores abdominales
Divaricatori addominali



COLLIN

260 mm - 10 1/4"		
x = 150 mm		
tk 17504-00	60 mm x 80 mm	60 mm x 75 mm

komplett mit complete with	Seitenvalven Lateral blades	Mittelvalve Center blade
complet avec	Valves latérales	Valve centrale
completo con	Valvas laterales	Valva central
completo con	Valve laterali	Valva centrale



HOLZBACH

260 mm - 10 1/4"		
x = 100 mm		
tk 17507-00	62 mm x 80 mm	80 mm x 80 mm

komplett mit complete with	Seitenvalven Lateral blades	Mittelvalve Center blade
complet avec	Valves latérales	Valve centrale
completo con	Valvas laterales	Valva centrale
completo con	Valve laterali	Valva centrale

Bauchdeckenhalter
Abdominal retractors

Ecarteurs abdominaux
Separadores abdominales
Divaricatori addominali

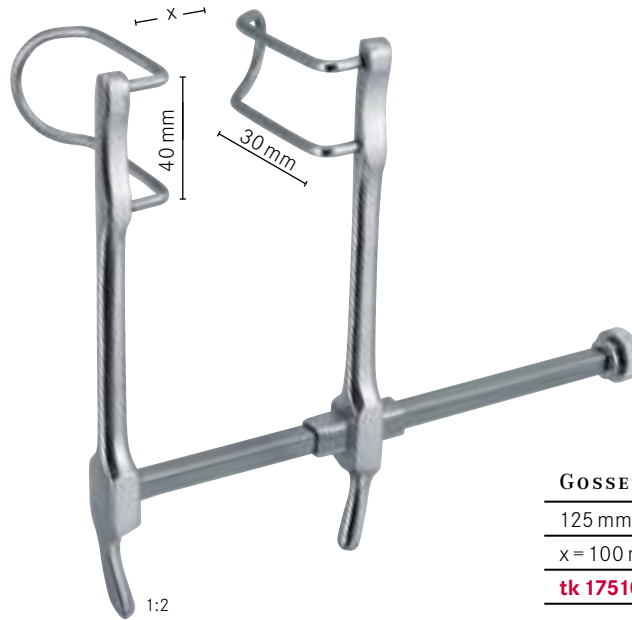

GOSSET

125 mm - 5"

x = 100 mm

tk 17510-90

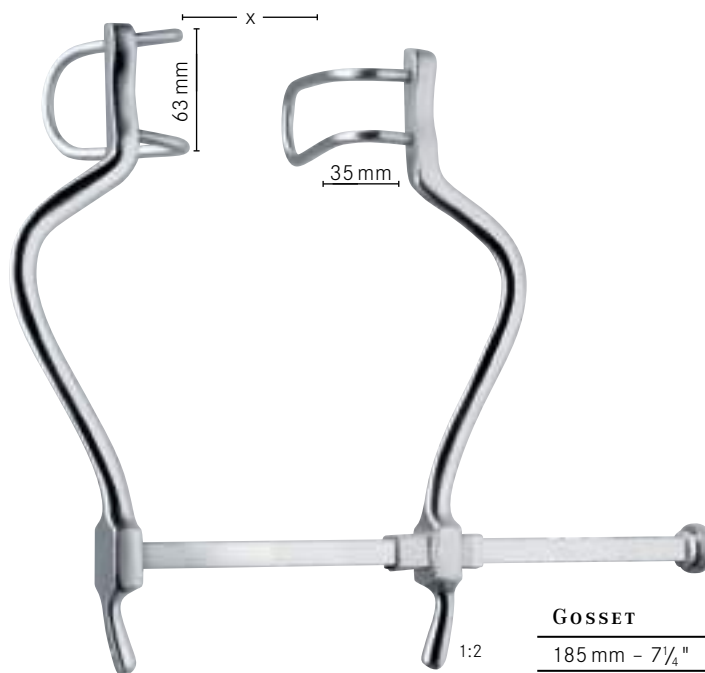

GOSSET

185 mm - 7 1/4"

x = 140 mm

tk 17520-14

Bauchdeckenhalter
Abdominal retractors

Ecarteurs abdominaux
Separadores abdominales
Divaricatori addominali

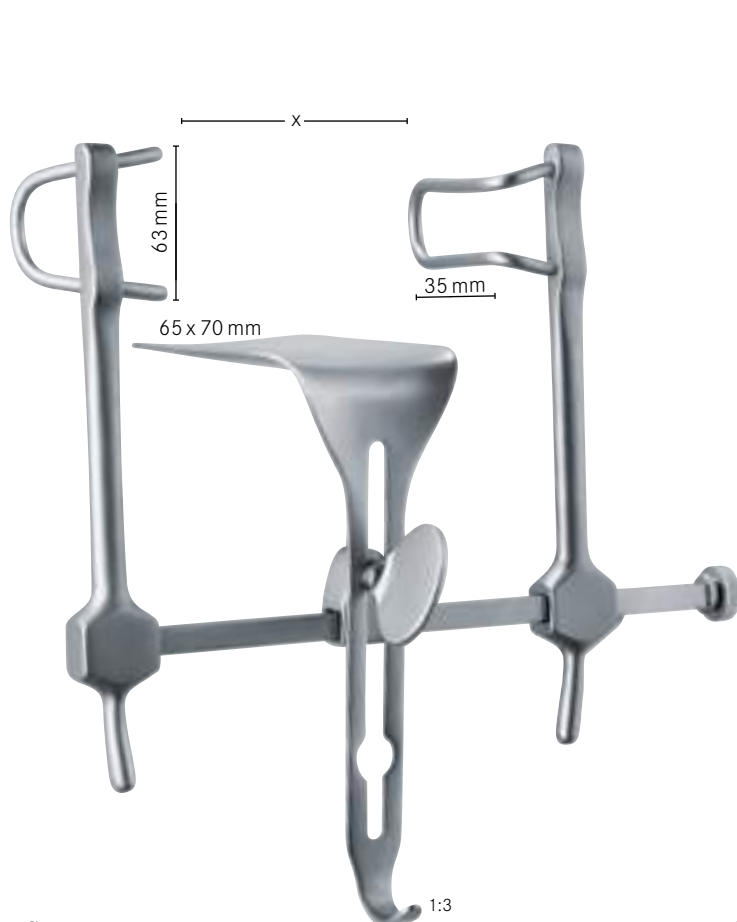

GOSSET

x = 160 mm		
tk 17530-16	35 mm x 63 mm	65 mm x 70 mm

komplett mit
complete with

Seitenvalven
Lateral blades

Mittelvalve
Center blade

complet avec
completo con
completo con

Valves latérales
Valvas laterales
Valve laterali

Valve centrale
Valva centrale
Valva centrale



BALFOUR

x = 200 mm		
tk 17540-20	35 mm x 100 mm	70 mm x 100 mm

komplett mit
complete with

Seitenvalven
Lateral blades

Mittelvalve
Center blade

complet avec
completo con
completo con

Valves latérales
Valvas laterales
Valve laterali

Valve centrale
Valva centrale
Valva centrale

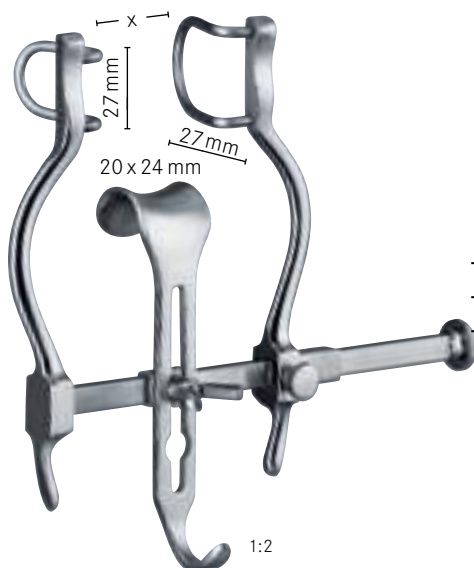

BALFOUR-BABY

x = 90 mm		
tk 17550-09	27 mm x 27 mm	20 mm x 24 mm

komplett mit
complete with

Seitenvalven
Lateral blades

Mittelvalve
Center blade

complet avec
completo con
completo con

Valves latérales
Valvas laterales
Valve laterali

Valve centrale
Valva centrale
Valva centrale

Bauchdeckenhalter
Abdominal retractors

Ecarteurs abdominaux
Separadores abdominales
Divaricatori addominali



BALFOUR

x = 180 mm		
tk 17570-18	35 mm x 70 mm	45 mm x 80 mm

komplett mit complete with	Seitenvalven Lateral blades	Mittelvalve Center blade
complet avec	Valves latérales	Valve centrale
completo con	Valvas laterales	Valva centrale
completo con	Valve laterali	Valva centrale

x = 250 mm		
tk 17560-25	35 mm x 100 mm	70 mm x 85 mm

komplett mit complete with	Seitenvalven Lateral blades	Mittelvalve Center blade
complet avec	Valves latérales	Valve centrale
completo con	Valvas laterales	Valva centrale
completo con	Valve laterali	Valva centrale

45 mm x 80 mm	tk 17571-80	
70 mm x 85 mm	tk 17572-85	
80 mm x 90 mm	tk 17573-90	

Mittelvalven, allein
Center blades, only

Valves centrales, seul
Valvas centrales, sola
Valve centrali, solo

BALFOUR US

x = 180 mm		
tk 17575-00	60 mm	70 mm x 85 mm
	80 mm	

komplett mit 2 Paar Valven complete with 2 pairs of blades	Mittelvalve Center blade
complet avec 2 paires de valves	Valve centrale
completo con 2 pares de valvas	Valva centrale
completo con 2 paia di valve	Valva centrale

60 mm	tk 17575-06	70 mm x 85 mm	tk 17572-85
80 mm	tk 17575-08		

**Seitenvalven, Paar
Lateral blades,**
complet avec,
completo con,
completo con,

**Mittelvalven, allein
Center blades, only**
Valves centrales, seul
Valvas centrales, sola
Valve centrali, solo

Bauchdeckenhalter
Abdominal retractors

Ecarteurs abdominaux
Separadores abdominales
Divaricatori addominali



RICARD

tk 17618-00	60 mm x 80 mm	55 mm x 70 mm
--------------------	---------------	---------------

komplett mit complete with	Seitenvalven Lateral blades	Mittelvalve Center blade
complet avec	Valves latérales	Valve centrale
completo con	Valvas laterales	Valva centrale
completo con	Valve laterali	Valva centrale



O'SULLIVAN-O'CONNOR

tk 17610-00	45 mm x 90 mm	70 mm x 100 mm
--------------------	---------------	----------------

komplett mit complete with	Seitenvalven Lateral blades	Mittelvalven Center blades
complet avec	Valves latérales	Valves centrales
completo con	Valvas laterales	Valvas centrales
completo con	Valve laterali	Valve centrali

tk 17620-00	70 mm x 85 mm	80 mm x 90 mm
--------------------	---------------	---------------

komplett mit complete with	Seitenvalven Lateral blades	Mittelvalve Center blade
complet avec	Valves latérales	Valve centrale
completo con	Valvas laterales	Valva centrale
completo con	Valve laterali	Valva centrale

Bauchdeckenhalter
Abdominal retractors

Ecarteurs abdominaux
Separadores abdominales
Divaricatori addominali



KIRSCHNER, OVAL

	240 mm x 300 mm	50 mm x 65 mm	80 mm x 90 mm	50 mm x 98 mm	35 mm x 105 mm
	tk 17625-01	tk 17640-02	tk 17640-06	tk 17640-07	tk 17640-08
	1 Rahmen	3 Valven	1 Valve	1 Valve	1 Valve
	1 Frame	3 Blades	1 Blade	1 Blade	1 Blade
	1 Cadre	3 Valves	1 Valve	1 Valve	1 Valve
	1 Cuadro	3 Valvas	1 Valva	1 Valva	1 Valva
	1 Quadro	3 Valve	1 Valva	1 Valva	1 Valva
tk 17625-00	x	x	x	x	x

Satz
Set
Jeu
Juego
Serie

KIRSCHNER

	240 mm x 240 mm	40 mm x 55 mm	50 mm x 65 mm
	tk 17630-01	tk 17640-01	tk 17640-02
	1 Rahmen, fest	2 Valven	2 Valven
	1 Frame, rigid	2 Blades	2 Blades
	1 Cadre, rigide	2 Valves	2 Valves
	1 Cuadro, rigido	2 Valvas	2 Valvas
	1 Quadro, rigido	2 Valve	2 Valve
tk 17630-00	x	x	x

Satz
Set
Jeu
Juego
Serie

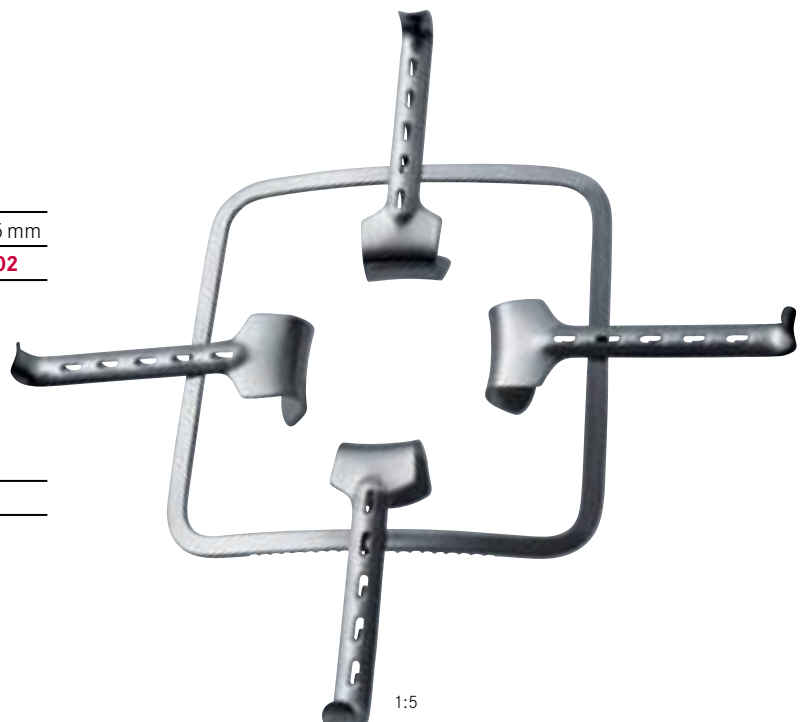

Bauchdeckenhalter
Abdominal retractors

Ecarteurs abdominaux
Separadores abdominales
Divaricatori addominali



FRANZ

	300 mm x 300 mm	40 mm x 60 mm	45 mm x 80 mm	50 mm x 65 mm	60 mm x 85 mm
	tk 17645-01	tk 17632-06	tk 17632-08	tk 17640-12	tk 17640-13
1 Rahmen, zusammenlegbar 1 Frame, foldable		2 Valven 2 Blades	2 Valven 2 Blades	2 Valven 2 Blades	2 Valven 2 Blades
1 Cadre pliant 1 Cuadro plegable		2 Valves 2 Valvas	2 Valves 2 Valvas	2 Valves 2 Valvas	2 Valves 2 Valvas
1 Quadro piegabile		2 Valve	2 Valve	2 Valve	2 Valve
tk 17645-00	x	x		x	
tk 17650-00	x	x	x	x	x

Satz
Set
Jeu
Juego
Serie



! Rahmen zusammenlegbar
Frame foldable
Cadre pliant
Cuadro plegable
Quadro piegabile

Bauchdeckenhalter
Abdominal retractors

Ecarteurs abdominaux
Separadores abdominales
Divaricatori addominali



Valven für Kirschner- und Franz-Rahmen
Blades for Kirschner- and Franz-frames

Valves pour cadres Kirschner et Franz
Valvas para los cuadros de Kirschner y Franz
Valve per i quadri di Kirschner e Franz



	40 mm x 60 mm	45 mm x 80 mm	40 mm x 55 mm	50 mm x 65 mm
Kirschner			tk 17640-01	tk 17640-02
Franz	tk 17632-06	tk 17632-08		tk 17640-12



	60 mm x 85 mm	80 mm x 90 mm	50 mm x 98 mm	35 mm x 105 mm
Kirschner	tk 17640-03	tk 17640-06	tk 17640-07	tk 17640-08
Franz	tk 17640-13		tk 17640-17	tk 17640-18

Wundspreizer
Retractors

Ecarteurs
Separadores
Divaricatori



ROCHARD

tk 17910-00

Fixierahmen, einseitig
Fixing frame, one sided

Cadre de fixation, unilatéralement
Marco de fijación, unilateralmente
Cornice di fissiagio, unilateralmente

ROCHARD

tk 17910-01

Fixierahmen, zweiseitig
Fixing frame, double sided

Cadre de fixation, deux côtes
Marco de fijación, bilateralmente
Cornice di fissiagio, bilateralmente



ROCHARD

tk 17911-00

Fixierahmen, zweiseitig
Fixing frame, double sided

Cadre de fixation, deux côtes
Marco de fijación, bilateralmente
Cornice di fissiagio, bilateralmente



50 x 95 mm	tk 17912-01
50 x 105 mm	tk 17912-02
60 x 120 mm	tk 17912-03
60 x 135 mm	tk 17912-04
60 x 155 mm	tk 17912-05

Wundspreizer
Retractors

Ecarteurs
Separadores
Divaricatori



1:2



1:2

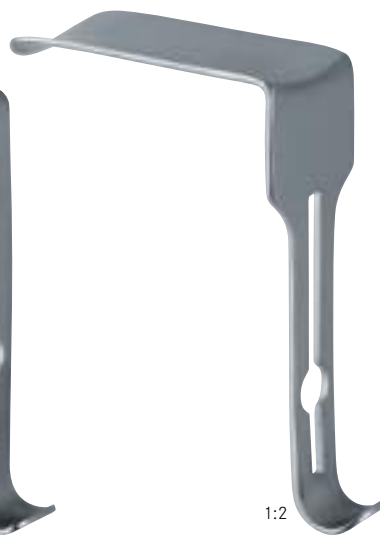

1:2



1:2

O'SULLIVAN-O'CONNOR

	Fig. 1	Fig. 2	Fig. 3
	45 mm x 17 mm	90 mm x 37 mm	90 mm x 45 mm
	tk 34138-03	tk 34138-04	tk 34138-05
tk 34138-00	x	x	x

komplett
complete
complet
completo
completo

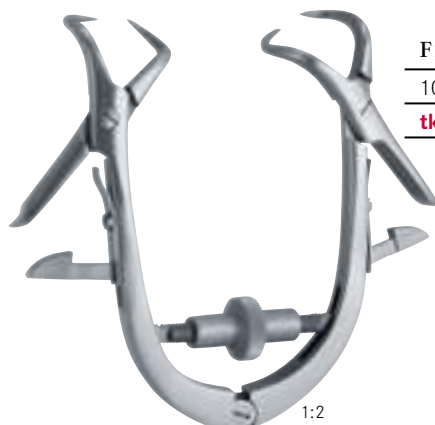

1:2

FRIEDMANN

100 mm - 4"

tk 34139-10

Bauchspatel
Abdominal spatulas

Spatulas abdominales
Espátulas abdominales
Spatole addominali



	30 mm	40 mm	50 mm
330 mm - 13"	tk 17882-30	tk 17882-40	tk 17882-50

biegsam
malleable
malléable
maleable
flessibile



MARTIN

200 mm - 8"	200 mm - 8"	250 mm - 9¾"
12 mm	17 mm	25 mm
tk 17884-12	tk 17884-17	tk 17884-25

weich
soft
souple
flexible
morbido

	6,5 mm	9,5 mm	13 mm	16 mm	19 mm	25 mm
200 mm - 8"	tk 17880-06	tk 17880-09	tk 17880-13	tk 17880-16	tk 17880-19	tk 17880-25

biegsam, sehr weich
malleable, very soft
malléable, très souple
maleable, muy flexible
flessibile, molto morbido



Bauchspatel
Abdominal spatulas

Spatulas abdominales
Espátulas abdominales
Spatole addominali



HABERER

200 mm - 8"	280 mm - 11"	300 mm - 12"
17 mm / 25 mm	25 mm / 30 mm	37 mm / 45 mm
tk 17886-25	tk 17886-30	tk 17886-45

biegsam
malleable
malléable
malleable
flessibile



REVERDIN

280 mm - 11"
46 mm x 60 mm
tk 17887-28

1:2

Bitte fordern Sie unseren Spezialkatalog an.
Please ask for our special catalogue.
Veuillez demander pour notre catalogue spécial.
Por favor preguntan para el catálogo especial.
Per favore domandate per il nostro catalogo speciale.

RETRAKTOR SYSTEME

RETRACTOR SYSTEMS

Das Tekno-Medical Retraktor System wurde speziell für den flexiblen Einsatz im OP konstruiert. Mit einer Vielzahl verschiedener Ringgrößen und -formen und unterschiedlichen Valvenformen, ist das TEKNO[®] Retraktor System bestens für alle möglichen Fachgebiete geeignet und kann, entsprechend den jeweiligen Anforderungen, für jeden Patienten individuell zusammengestellt werden.

The Tekno-Medical Multiple Retractor Set has been designed to provide the flexibility necessary for the Operating Room. With great variety of different ring possibilities and retractor blade styles to choose from the TEKNO[®] retractor system is suited for use in many different specialties and can be configured to fit the special needs of almost any patient.

Laminektomiesperrer
Laminectomy retractors

Ecarteurs pour laminectomie
Separadores para laminectomia
Divaricatori per laminectomia



CLOWARD

160 mm – 6¼"

tk 17783-00

komplett mit je 2 Valven Fig. 1 - Fig. 5
complete with 2 blades ea. Fig. 1 - Fig. 5
complet avec 2 valves chacune Fig. 1 - Fig. 5
completo con 2 valvas de cada Fig. 1 - Fig. 5
completo con 2 valve Fig. 1 - Fig. 5

tk 17782-00

Sperrer ohne Valven
Retractor without blades
Ecarteur sans valves
Separador sin valvas
Divaricatore senza valve



Fig. 1	x = 60 mm	tk 17783-01
Fig. 2	x = 55 mm	tk 17783-02
Fig. 3	x = 50 mm	tk 17783-03
Fig. 4	x = 45 mm	tk 17783-04
Fig. 5	x = 40 mm	tk 17783-05

stumpf
blunt
mousse
roma
smussa

250 mm – 9¾"

tk 17781-00

komplett mit je 2 Valven Fig. 1 - Fig. 5
complete with 2 blades ea. Fig. 1 - Fig. 5
complet avec 2 valves chacune Fig. 1 - Fig. 5
completo con 2 valvas de cada Fig. 1 - Fig. 5
completo con 2 valve Fig. 1 - Fig. 5

tk 17780-00

Sperrer ohne Valven
Retractor without blades
Ecarteur sans valves
Separador sin valvas
Divaricatore senza valve



Fig. 1	x = 60 mm	tk 17781-01
Fig. 2	x = 55 mm	tk 17781-02
Fig. 3	x = 50 mm	tk 17781-03
Fig. 4	x = 45 mm	tk 17781-04
Fig. 5	x = 40 mm	tk 17781-05

gezahnt
toothed
dentelée
dentada
dentata

Laminektomiesperrer
Laminectomy retractors

Ecarteurs pour laminectomie
Separadores para laminectomia
Divaricatori per laminectomia



INGE

1:3

1:3

165 mm - 6½"	270 mm - 10¾"
tk 17785-16	tk 17785-27



CLOWARD-
VERTEBRA

160 mm - 6¼"

tk 17797-16

1:2

Laminektomiesperrer
Laminectomy retractors

Ecarteurs pour laminectomie
Separadores para laminectomia
Divaricatori per laminectomia

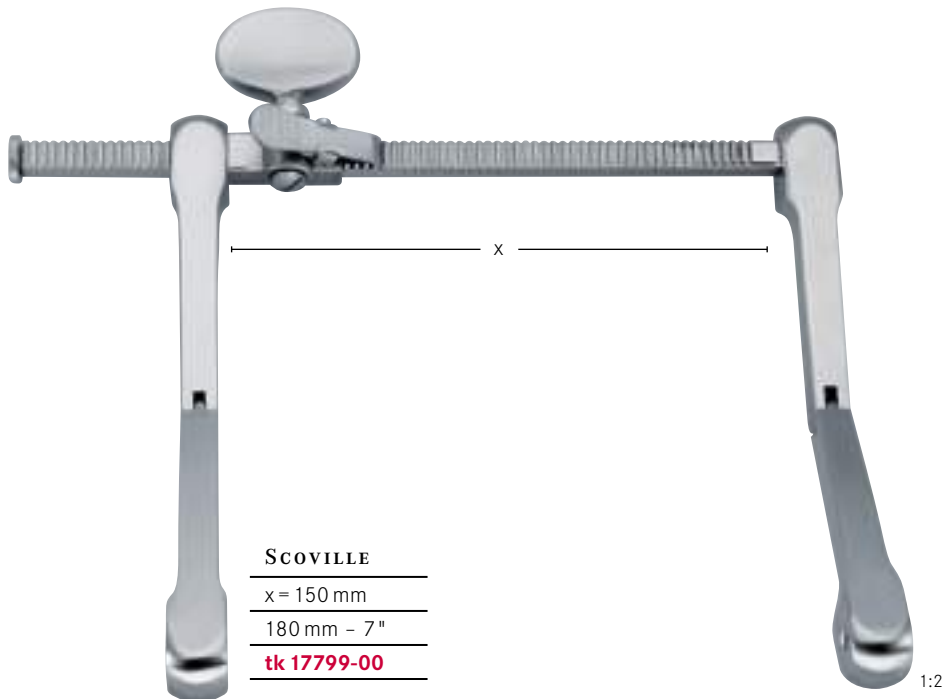
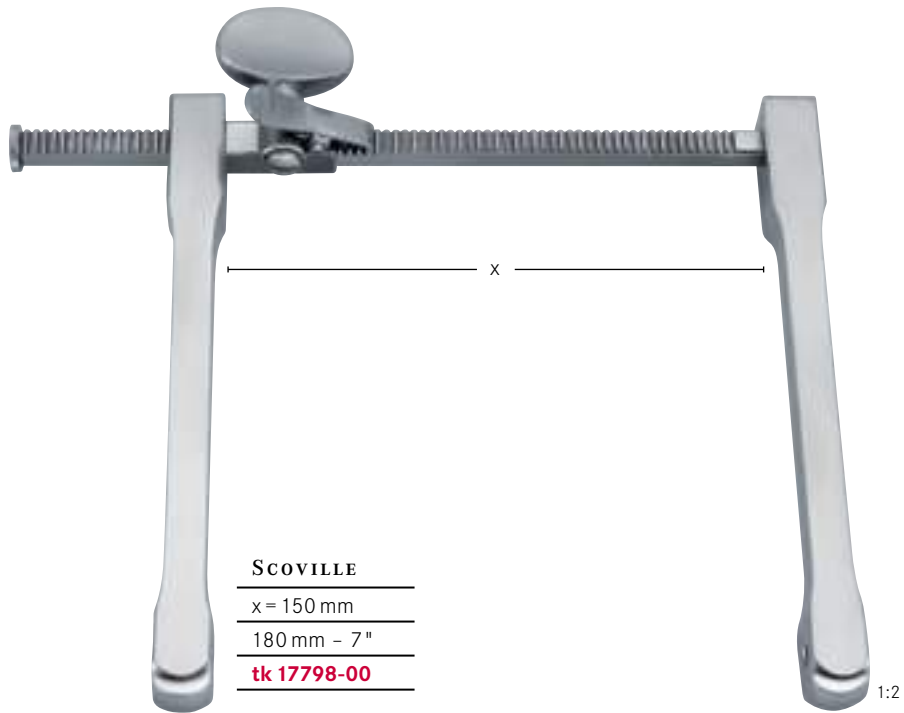

Laminektomiesperrer
Laminectomy retractors

Ecarteurs pour laminectomie
Separadores para laminectomia
Divaricatori per laminectomia

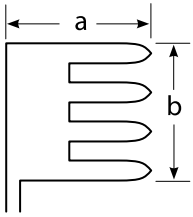

SCOVILLE

50 mm - 2"	tk 17800-05	tk 17801-05
70 mm - 2 ³ / ₄ "	tk 17800-07	tk 17801-07

stumpf
blunt
mousse
roma
smussa

spitz
sharp
pointu
aguda
acuta



TAYLOR

a = 48 mm - b = 50 mm - 2" x 2"	tk 17802-05
a = 63 mm - b = 50 mm - 2 ¹ / ₂ " x 2"	tk 17802-06
a = 64 mm - b = 64 mm - 3 ¹ / ₄ " x 2 ¹ / ₄ "	tk 17802-08



SCOVILLE

a = 40 mm - b = 37 mm - 1 ¹ / ₂ " x 1 ¹ / ₂ "	tk 17803-04
a = 65 mm - b = 44 mm - 2 ¹ / ₂ " x 1 ³ / ₄ "	tk 17803-06



TAYLOR

a = 100 mm - b = 42 mm - 4" x 1 ⁶ / ₈ "	tk 17804-02
---	--------------------

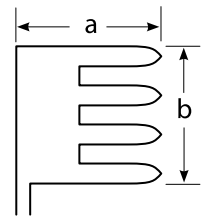
Laminektomiesperrer
Laminectomy retractors
Ecarteurs pour laminectomie
Separadores para laminectomia
Divaricatori per laminectomia

MEYERDING

a = 57 mm - b = 25 mm - 2 1/4" x 1"	tk 17805-01
a = 76 mm - b = 25 mm - 3" x 1"	tk 17805-02
a = 88 mm - b = 51 mm - 3 1/2" x 2"	tk 17805-03

SCOVILLE

a = 57 mm - b = 25 mm - 2 1/4" x 1"	tk 17806-01
a = 57 mm - b = 38 mm - 2 1/4" x 1 1/2"	tk 17806-02
a = 64 mm - b = 50 mm - 2 1/2" x 2"	tk 17806-03
a = 75 mm - b = 25 mm - 3" x 1"	tk 17806-04

EPSTEIN

a = 56 mm - b = 25 mm - 2 1/4" x 1"	tk 17807-01
-------------------------------------	--------------------

HIBBS

a = 50 mm - b = 20 mm - 2" x 3/4"	tk 17808-01
a = 50 mm - b = 25 mm - 2" x 1"	tk 17808-02
a = 50 mm - b = 50 mm - 2" x 2"	tk 17808-03
a = 63 mm - b = 25 mm - 2 1/2" x 1"	tk 17808-04
a = 63 mm - b = 37 mm - 2 1/2" x 1 1/2"	tk 17808-05
a = 76 mm - b = 25 mm - 3" x 1"	tk 17808-06
a = 76 mm - b = 38 mm - 3" x 1 1/2"	tk 17808-07
a = 76 mm - b = 50 mm - 3" x 2"	tk 17808-08
a = 76 mm - b = 63 mm - 3" x 2 1/2"	tk 17808-09
a = 90 mm - b = 25 mm - 3 1/2" x 1"	tk 17808-10
a = 90 mm - b = 37 mm - 3 1/2" x 1 1/2"	tk 17808-11
a = 102 mm - b = 25 mm - 4" x 1"	tk 17808-12
a = 102 mm - b = 50 mm - 4" x 2"	tk 17808-13

Laminektomiesperrer
Laminectomy retractors

Ecarteurs pour laminectomie
Separadores para laminectomia
Divaricatori per laminectomia



CASPAR

tk 17829-00

komplett mit 5 medial Valven tk 17826-01 - tk 17826-05
und mit 5 lateral Valven tk 17827-01 - tk 17827-05
complete with 5 medial blades tk 17826-01 - tk 17826-05
and with 5 lateral blades tk 17827-01 - tk 17827-05
complet avec 5 valves médianes tk 17826-01 - tk 17826-05
et avec 5 valves latérales tk 17827-01 - tk 17827-05
completo con 5 valvas mediales tk 17826-01 - tk 17826-05
y con 5 valvas laterales tk 17827-01 - tk 17827-05
completo con 5 valve mediali tk 17826-01 - tk 17826-05
e con 5 valve laterali tk 17827-01 - tk 17827-05

tk 17823-00

komplett mit 5 Valven tk 17824-01 - tk 17824-05
complete with 5 blades tk 17824-01 - tk 17824-05
complet avec 5 valves tk 17824-01 - tk 17824-05
completo con 5 valvas tk 17824-01 - tk 17824-05
completo con 5 valve tk 17824-01 - tk 17824-05

tk 17829-01

Sperrer ohne Valven
Retractor without blades
Ecarteur sans valves
Separador sin valvas
Divaricatore senza valve

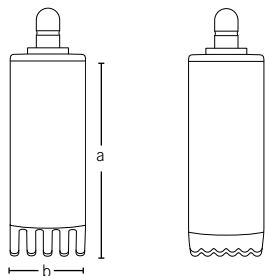

CASPAR

	medial	lateral
a = 40 mm - b = 23 mm	tk 17826-01	tk 17827-01
a = 45 mm - b = 23 mm	tk 17826-02	tk 17827-02
a = 50 mm - b = 23 mm	tk 17826-03	tk 17827-03
a = 55 mm - b = 23 mm	tk 17826-04	tk 17827-04
a = 60 mm - b = 23 mm	tk 17826-05	tk 17827-05

tk 17823-01

Sperrer ohne Valven
Retractor without blades
Ecarteur sans valves
Separador sin valvas
Divaricatore senza valve



CASPAR

a = 45 mm - b = 23 mm	tk 17824-01
a = 50 mm - b = 23 mm	tk 17824-02
a = 55 mm - b = 23 mm	tk 17824-03
a = 60 mm - b = 23 mm	tk 17824-04
a = 65 mm - b = 23 mm	tk 17824-05

stumpf
blunt

mousse
roma
smussa

Laminektomiesperrer
Laminectomy retractors

Ecarteurs pour laminectomie
Separadores para laminectomia
Divaricatori per laminectomia



CASPAR

tk 17828-00

komplett mit 6 Valven tk 17831-01 und tk 17832-02 - 06
complete with 6 blades tk 17831-01 and tk 17832-02 - 06
complet avec 6 valves tk 17831-01 et tk 17832-02 - 06
completo con 6 valvas tk 17831-01 y tk 17832-02 - 06
completo con 6 valve tk 17831-01 e tk 17832-02 - 06

tk 17828-10

Sperrer ohne Valven
Retractor without blades
Ecarteur sans valves
Separador sin valvas
Divaricatore senza valve



tk 17830-00

komplett mit 5 Valven tk 17824-01 - tk 17824-05
complete with 5 blades tk 17824-01 - tk 17824-05
complet avec 5 valves tk 17824-01 - tk 17824-05
completo con 5 valvas tk 17824-01 - tk 17824-05
completo con 5 valve tk 17824-01 - tk 17824-05

tk 17830-01

Sperrer allein, mit Schlüssel
Retractor only, with key
Ecarteur seul avec clé
Separador solo con llave
Divaricatore solo con chiave

tk 17830-02

Schlüssel
Key
Clé
Llave
Chiave



Laminektomiesperrer
Laminectomy retractors

Ecarteurs pour laminectomie
Separadores para laminectomia
Divaricatori per laminectomia



CASPAR

38 mm	58 mm
tk 17831-01	tk 17831-02

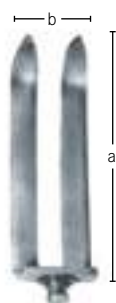

a = 35 mm - b = 22 mm	tk 17832-01
a = 40 mm - b = 22 mm	tk 17832-02
a = 45 mm - b = 22 mm	tk 17832-03
a = 50 mm - b = 22 mm	tk 17832-04
a = 55 mm - b = 22 mm	tk 17832-05
a = 60 mm - b = 22 mm	tk 17832-06
a = 65 mm - b = 22 mm	tk 17832-07
a = 70 mm - b = 22 mm	tk 17832-08

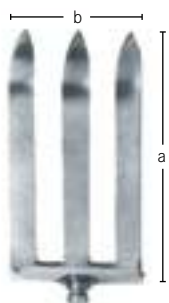

a = 35 mm - b = 37 mm	tk 17833-01
a = 40 mm - b = 37 mm	tk 17833-02
a = 45 mm - b = 37 mm	tk 17833-03
a = 50 mm - b = 37 mm	tk 17833-04
a = 55 mm - b = 37 mm	tk 17833-05
a = 60 mm - b = 37 mm	tk 17833-06
a = 65 mm - b = 37 mm	tk 17833-07
a = 70 mm - b = 37 mm	tk 17833-08



a = 35 mm - b = 52 mm	tk 17834-01
a = 40 mm - b = 52 mm	tk 17834-02
a = 45 mm - b = 52 mm	tk 17834-03
a = 50 mm - b = 52 mm	tk 17834-04
a = 55 mm - b = 52 mm	tk 17834-05
a = 60 mm - b = 52 mm	tk 17834-06
a = 65 mm - b = 52 mm	tk 17834-07
a = 70 mm - b = 52 mm	tk 17834-08

Wundspreizer zur Mikrodiskektomie
Retractors for Micro-Lumbar Discectomy

Retractors pour la micro discectomie lumbaire
Retractor para la micro discectomia lumbar
 Divaricatore per la micro dissezione lombare

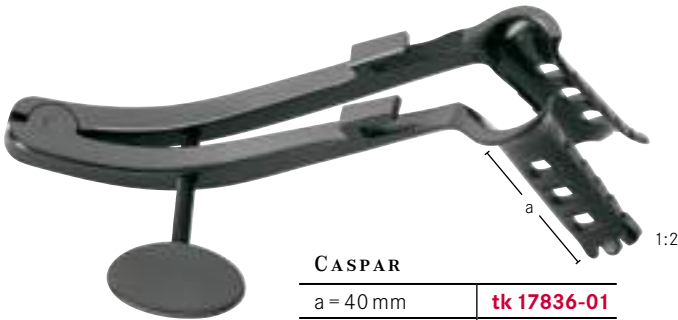

CASPAR

a = 40 mm	tk 17836-01
a = 45 mm	tk 17836-02
a = 50 mm	tk 17836-03
a = 55 mm	tk 17836-04
a = 60 mm	tk 17836-05
a = 65 mm	tk 17836-06
a = 75 mm	tk 17836-07
a = 85 mm	tk 17836-08



Mit schwarzer Oberfläche
With black finish
 Avec finition noir
 Con color negro
 Con superficie nera



CASPAR

	tk 17837-00
--	--------------------



Mit schwarzer Oberfläche
With black finish
 Avec finition noir
 Con color negro
 Con superficie nera

CASPAR

a = 35 mm	tk 17837-01	
a = 40 mm	tk 17837-02	tk 17838-01
a = 45 mm	tk 17837-03	tk 17838-02
a = 50 mm	tk 17837-04	tk 17838-03
a = 55 mm	tk 17837-05	tk 17838-04
a = 60 mm	tk 17837-06	tk 17838-05
a = 65 mm	tk 17837-07	tk 17838-06
a = 70 mm		tk 17838-07
a = 75 mm	tk 17837-08	
a = 85 mm	tk 17837-09	

Hypophysenspekulum
Speculum for hypophysectomy

Spéculum pour hypophysectomie
Especulo para hypophysectomia
 Specolo per ipofisectomia



Mit schwarzer Oberfläche
With black finish

Avec finition noir

Con color negro

Con superficie nera



1:1

x = 70 mm	tk 24927-70
x = 90 mm	tk 24927-90
x = 110 mm	tk 24928-10

Spekulum für trans-sphenoidale Hypophysectomie

Speculum for trans-sphenoidal hypophysectomy

Spéculum pour hypophysectomie trans-sphenoidale

Especulo para hypophysectomia trans-sphenoidal

Specolo per ipofisectomia trans-sfenoidale



Naht | Suture
Suture | *Sutura*
Sutura



Nadelhalter | Porte-aiguilles
Needle holders | Porta-agujas
Porta aghi



CRILE-MURRAY

150 mm - 6"

tk 20001-15



CRILE-WOOD

150 mm - 6"

tk 20002-15

180 mm - 7"

tk 20002-18



HEGAR-BAUMGARTNER

140 mm - 5 3/4"

tk 20003-14



BROWN

130 mm - 5"

tk 20315-13

180 mm - 7"

tk 20315-18



COLLIER

125 mm - 5"

tk 20301-12

kräftiges Modell, Maul diagonal gerieft
heavy pattern, diagonally serrated jaw
modèle fort, mors strié diagonalement
modelo fuerte, boca estriada diagonalmente
modello forte, morso con striae diagonali

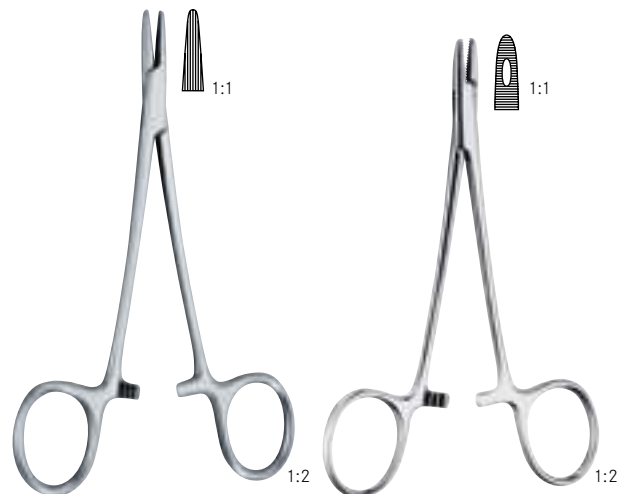

DERF

125 mm - 5"

tk 20308-12

120 mm - 4 3/4"

tk 20008-12

Nadelhalter | Porte-aiguilles
Needle holders | Porta-agujas
Porta aghi



WEBSTER

130 mm - 5"

tk 20009-13

glatt
smooth

lisse
liso
liscio

1:2



HALSEY

130 mm - 5"

tk 20010-13



tk 20011-13

glatt
smooth

lisse
liso
liscio

gerieft
serrated

strié
estriada
zigrinato

1:2

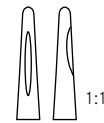
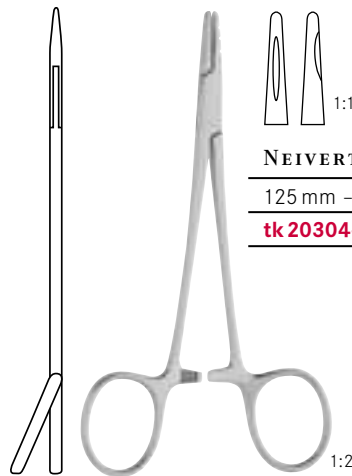

NEIVERT

125 mm - 5"

tk 20304-13

1:2

Nadelhalter
Needle holders
Porte-aiguilles
Porta-agujas
Porta aghi

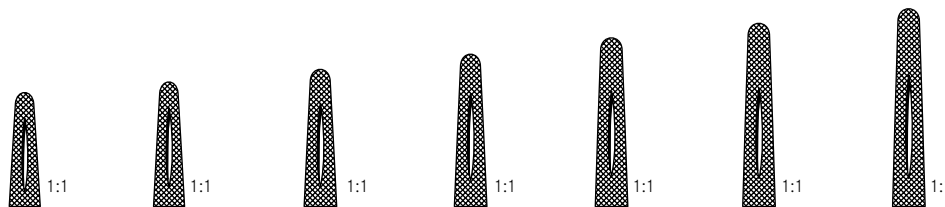

MAYO-HEGAR

140 mm - 5½"	160 mm - 6¼"	180 mm - 7"	200 mm - 8"	240 mm - 9½"	260 mm - 10¼"	300 mm - 12"
tk 20012-14	tk 20012-16	tk 20012-18	tk 20012-20	tk 20012-24	tk 20012-26	tk 20012-30

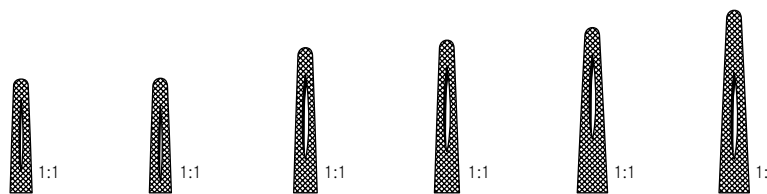

140 mm - 5½"	160 mm - 6¼"	180 mm - 7"	200 mm - 8"	240 mm - 9½"	260 mm - 10¼"
tk 20013-14	tk 20013-16	tk 20013-18	tk 20013-20	tk 20013-24	tk 20013-26

schlankes Modell
delicate pattern
modèle fin
modelo delicado
modello delicato

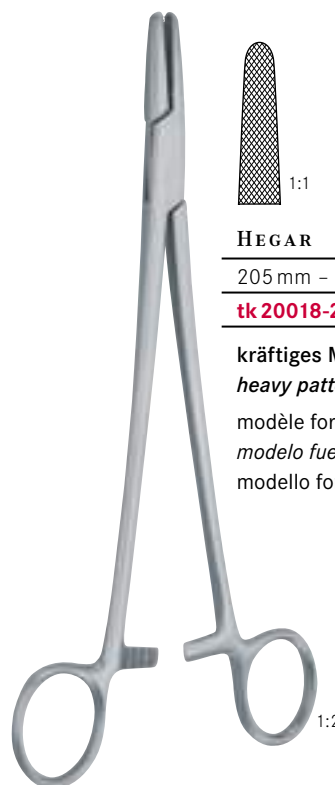

HEGAR

205 mm - 8"
tk 20018-20

kräftiges Modell
heavy pattern
modèle fort
modelo fuerte
modello forte

Nadelhalter | Porte-aiguilles
Needle holders | Porta-agujas
Porta aghi



HEANEY

160 mm - 6¼"	tk 20015-16
180 mm - 7"	tk 20015-18
200 mm - 8"	tk 20015-20



SAROT

180 mm - 7"	tk 20024-18
260 mm - 10¼"	tk 20024-26



JAMESON

235 mm - 9¼"	tk 20345-23
--------------	--------------------

Nadelhalter | Porte-aiguilles
Needle holders | Porta-agujas
 Porta aghi



MASSON
 270 mm - 10³/₄"
tk 20005-27



FINOCHIETTO
 270 mm - 10³/₄"
tk 20006-27



STRATTE
 230 mm - 9"
tk 20007-23

Nadelhalter | Porte-aiguilles
Needle holders | Porta-agujas
Porta aghi



WANGENSTEEN

270 mm - 10³/₄ "

tk 20026-27



BOZEMANN (WERTHEIM)

200 mm - 8 "

tk 20030-20

240 mm - 9¹/₂ "

tk 20030-24



**THOMSON-WALKER
(BOZEMANN)**

200 mm - 8 "

tk 20032-20



Nadelhalter | Porte-aiguilles
Needle holders | Porta-agujas
 Porta aghi

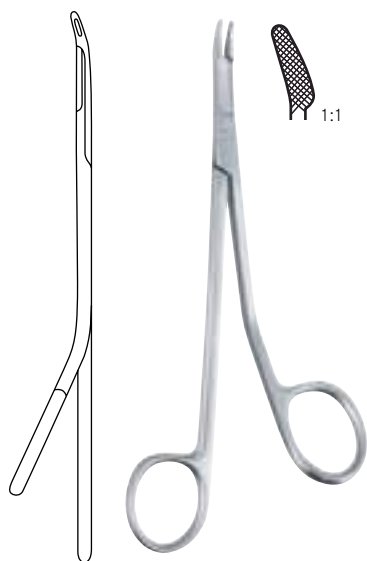

GILLIES
 145 mm - 5 3/4" | **tk 20035-14**



GILLIES
 160 mm - 6 1/4" | **tk 20035-16**



OLSEN-HEGAR
 140 mm - 5 1/2" | **tk 20036-14**
 170 mm - 6 3/4" | **tk 20036-17**
 190 mm - 7 1/2" | **tk 20036-19**

Nadelhalter
Needle holders

Porte-aiguilles
Porta-agujas
Porta aghi



MATHIEU

140 mm - 5½"	tk 20100-14		tk 20103-14
170 mm - 6¾"	tk 20100-17	tk 20101-17	tk 20103-17
200 mm - 8"	tk 20100-20	tk 20101-20	tk 20103-20
240 mm - 9½"	tk 20100-24		

kräftiges Modell
heavy pattern

modèle fort
modelo fuerte
modello forte

schlankes Modell
delicate pattern

modèle fin
modelo delicado
modello delicato



MATHIEU-OLSEN

140 mm - 5½"	tk 20106-14
170 mm - 6¾"	tk 20106-17
200 mm - 8"	tk 20106-20







MATHIEU

170 mm - 6¾"	tk 20110-17
200 mm - 8"	tk 20110-20

Nadelhalter
Needle holders
Porte-aiguilles
Porta-agujas
Porta aghi



CASTROVIEJO- JACOBSON	 1:1	 1:1	 1:1	 1:1
140 mm - 5½"		tk 20210-14		tk 20211-14
150 mm - 6"	tk 20204-15	tk 20210-15	tk 20205-15	tk 20211-15
180 mm - 7"	tk 20204-18	tk 20210-18	tk 20205-18	tk 20211-18
210 mm - 8¼"	tk 20204-21	tk 20210-21	tk 20205-21	tk 20211-21

glattes Maul
smooth jaws
mors lisse
boca lisa
morso liscio

gerade, ohne Sperre
straight, without ratchet
droit, sans crémaillère
recta, sin cremallera
retto, senza cremagliera

gerade, mit Sperre
straight, with ratchet
droit, avec crémaillère
recta, con cremallera
retto, con cremagliera

gebogen, ohne Sperre
curved, without ratchet
courbe, sans crémaillère
curva, sin cremallera
curvo, senza cremagliera

gebogen, mit Sperre
curved, with ratchet
courbe, avec crémaillère
curva, con cremallera
curvo, con cremagliera



TOENNIS

180 mm - 7"
tk 20420-18



LICHTENBERG

170 mm - 6¾" **tk 20115-17**
200 mm - 8" **tk 20115-20**

Nadelhalter
Needle holders

Porte-aiguilles
Porta-agujas
Porta aghi



BOYNTON

120 mm - 4 3/4"

tk 20250-12

1:2



KALT

140 mm - 5 1/2"

tk 20260-14

1:2



ARRUGA

160 mm - 6 1/4"

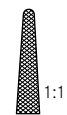

1:1

tk 20038-16

gerade
straight

droit

recta

retto

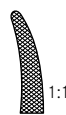

1:1

tk 20039-16

gebogen
curved

courbe

curva

curvo

1:2

Nadelhalter mit Hartmetalleinsätzen im Maulbereich Needle holders with tungsten-carbide inserts in the jaws

Porte-aiguilles avec des inserts de carbure de tungstène dans les mors
Porte-agujas con insertos de carburo tungsteno en las bocas
Port'aghi con inserti in carburo di tungsteno



Alle Nadelhalter mit „tucar“ Hartmetalleinsätzen bieten einen sicheren, festen Halt der Nadel und verhindern deren Verdrehen. Zur Kennzeichnung sind alle Hartmetall-Nadelhalter an den Ringgriffen bzw. den Branchen vergoldet.

All the needle holders with “tucar” tungsten-carbide inserts offer a safe and secure grip of the needle and prevent the twisting of the same. Needle holders with tungsten-carbide inserts are identified by gold-plated rings or handles.

Tous les porte-aiguilles avec des inserts «tucar» de carbure de tungstène garantissent que les aiguilles sont tenues sûres et fortes et qu'elles ne peuvent pas se tordre. Les portes aiguilles avec des inserts de tungstène de carbure peuvent être reconnus à leurs bagues ou manches dorées.

Todas las porta-agujas “tucar” con los insertos de carburo tungsteno aseguran la sujeción firme y seguro de las agujas que evita la torsión de las cuales. Porta-agujas con insertos de carburo de tungsteno se reconocen por los anillos o mangos dorados.

Tutti i portaaghi con inserti in carburo di tungsteno “tucar” (tungsten-carbide) assicurano una presa dell'ago sicura e forte, che previene la torsione dall'ago stesso. I port'aghi con inserto in carburo di tungsteno sono riconoscibili per la doratura del manico o degli anelli.

0.5 mm

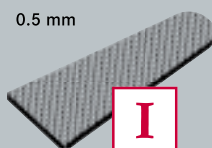

I

Normal für Nadeln und Nahtmaterial bis Stärke 4-0
Regular for use with needles and sutures up to size 4-0

Normale pour aiguilles et matériel à suture jusqu'à l'épaisseur de 4-0
Normal para agujas y material de suturar hasta el espesor de 4-0
Normale per aghi e materiale per sutura fino ad uno spessore di 4-0

0.4 mm

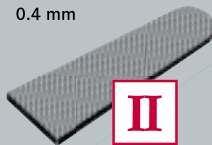

II

Fein für feine Nadeln und Nahtmaterial Stärke 5-0 + 6-0
Fine for delicate needles and sutures sizes 5-0 + 6-0

Fino pour aiguilles fines et matériel à suture à l'épaisseur 5-0 + 6-0
Fine para agujas finas y material de suturar espesores 5-0 + 6-0
Fine per aghi fini e materiale per sutura con spessore 5-0 + 6-0

0.3 mm

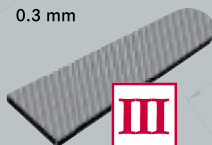

III

Extrafein für Mikro-Nadeln und Nahtmaterial Stärke 7-0 bis 10-0
Extrafine for use with micro-needles and sutures size 7-0 and 10-0

Extrafino pour micro-aiguilles et matériel à suture à l'épaisseur 7-0 à 10-0
Extrafine para micro-agujas y material de suturas espesor 7-0 y 10-0
Extrafine per micro-aghi e materiale per sutura 7-0 e 10-0

Glatt für feine Nadeln und Nahtmaterial Stärke 7-0 bis 12-0
Smooth for delicate needles and sutures sizes 7-0 and 12-0



IV

Liso pour aiguilles fines et matériel à suture à l'épaisseur 7-0 à 12-0
Lisse para agujas finas y material de suturas espesor 7-0 y 12-0
Liscia per aghi fini e materiale per sutura 7-0 e 12-0

Nadelhalter
Needle holders

Porte-aiguilles
Porta-agujas
Porta aghi

TUCAR **TK**



HEGAR-BAUMGARTNER

140 mm - 5½"

tk 20503-14 tucar





BABY-CRILE-WOOD

150 mm - 6"

tk 20504-15 tucar





CRILE-WOOD

	 1:1	 1:1	 1:1
	150 mm - 6"	180 mm - 7"	200 mm - 8"
	tk 20502-15 tucar	tk 20502-18 tucar	tk 20502-20 tucar
	tk 20502-15 LH	tk 20502-18 LH	-

Linkshänder
left-hander

gaucher
zurdo
mancino

 1:1	 1:1
230 mm - 9"	260 mm - 10¼"
tk 20502-23 tucar	tk 20502-26 tucar
tk 20502-23 LH	-

Nadelhalter
Needle holders

Porte-aiguilles
Porta-agujas
Porta aghi



DERF (WRIGHT)

120 mm - 4¾"

tk 20508-12 tucar

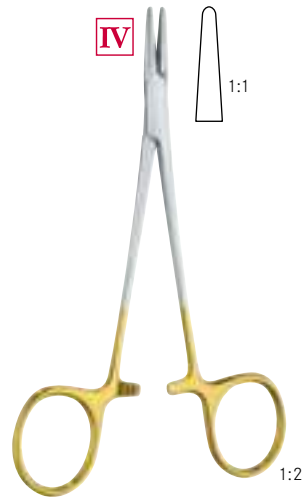

WEBSTER

130 mm - 5"

tk 20509-13 tucar

glatt
smooth

lisse
lisa
liscio



HALSEY

130 mm - 5"

glatt
smooth

lisse
lisa
liscio



tk 20510-13 tucar



gerieft
serrated

strié
estriada
zigrinato



tk 20511-13 tucar



KILNER

135 mm - 5¼"

tk 20533-13 tucar

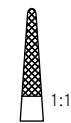

Nadelhalter | Porte-aiguilles
Needle holders | Porta-agujas
Porta aghi

TUCARTK

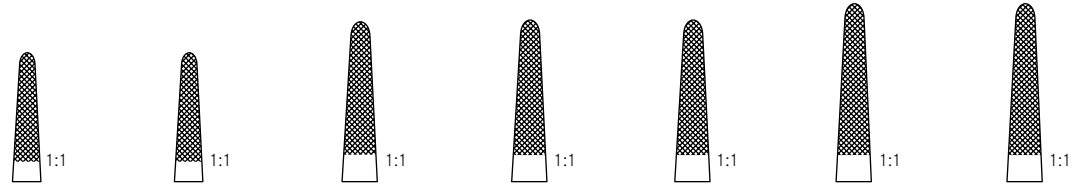

MAYO-HEGAR

140 mm - 5½"	160 mm - 6¼"	180 mm - 7"	200 mm - 8"	240 mm - 9½"	260 mm - 10¼"	300 mm - 12"
tk 20512-14	tk 20512-16	tk 20512-18	tk 20512-20	tk 20512-24	tk 20512-26	tk 20512-30
-	tk 20512-16 LH	-	tk 20512-20 LH	tk 20512-24 LH	tk 20512-26 LH	-

Linkshänder
left-hander

gaucher
zurdo
mancino



1:2

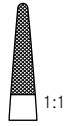
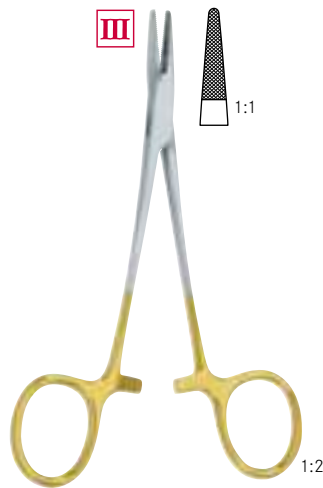

1:2

NEIVERT (MASING)

130 mm - 5"

tk 20517-13 tucar

ein Ring abgewinkelt
one ring angled

une bague coudée
un anillo acodado
un anello angolato

CONVERSE

130 mm - 5"

tk 20518-13 tucar



MATHIEU-OLSEN

140 mm - 5½"

tk 20516-14 tucar

170 mm - 6¾"

tk 20516-17 tucar

200 mm - 8"

tk 20516-20 tucar

Nadelhalter
Needle holders
Porte-aiguilles
Porta-agujas
Porta aghi

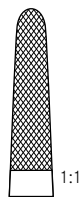
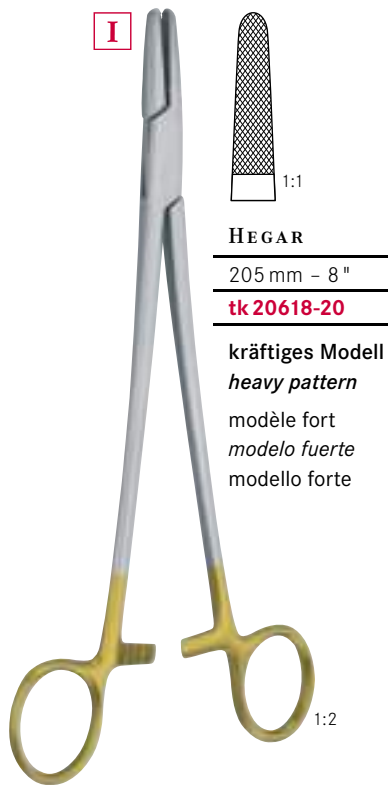

HEGAR

205 mm - 8"

tk 20618-20

kräftiges Modell
heavy pattern
modèle fort
modelo fuerte
modello forte



II



GILLIES

145 mm - 5 3/4"

tk 20535-14 tucar



GILLIES

160 mm - 6 1/4"

tk 20535-16 tucar

160 mm - 6 1/4"

tk 20535-16 LH

Linkshänder
left-hander
gaucher
zurdo
mancino



FOSTER-GILLIES

120 mm - 4 3/4"



III 1:2

gerade, gerieft
straight, serrated
droit, strié
recta, estriada
retto, zigrinato



IV 1:2

gerade, glatt
straight, smooth
droit, lisse
recta, lisa
retto, liscio



III 1:2

gebogen, gerieft
curved, serrated
courbe, strié
curva, estriada
curvo, zigrinato



IV 1:2

gebogen, glatt
curved, smooth
courbe, lisse
curva, lisa
curvo, liscio



II

OLSEN-HEGAR

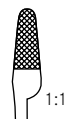

1:1



1:1

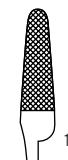

1:1

140 mm - 5 1/2"

tk 20536-14 tucar

170 mm - 6 3/4"

tk 20536-17 tucar

190 mm - 7 1/2"

tk 20536-19 tucar

Nadelhalter
Needle holders

Porte-aiguilles
Porta-agujas
Porta aghi

TUCARTK

II



STRATTE
230 mm - 9"
tk 20507-23 tucar

I



HEANEY

160 mm - 6¼"	tk 20515-16 tucar
180 mm - 7"	tk 20515-18 tucar
200 mm - 8"	tk 20515-20 tucar

I



**BOZEMANN
(WERTHEIM)**



200 mm - 8"	240 mm - 9½"	260 mm - 10¼"	300 mm - 12"
tk 20530-20 tucar	tk 20530-24 tucar	tk 20530-26 tucar	tk 20530-30 tucar



Nadelhalter | Porte-aiguilles
Needle holders | Porta-agujas
 Porta aghi



MASSON
 270 mm - 10³/₄"
tk 20505-27 tucar



FINOCHIETTO
 270 mm - 10³/₄"
tk 20506-27 tucar







WANGENSTEEN
 270 mm - 10³/₄"
tk 20526-27 tucar

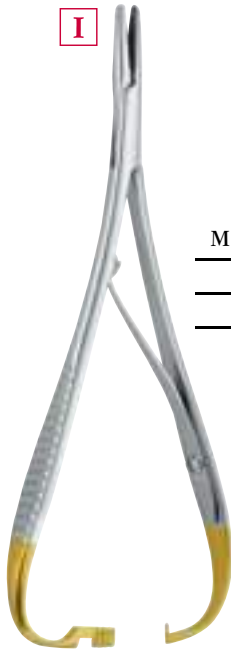

Nadelhalter | Porte-aiguilles
 Needle holders | Porta-agujas
 Porta aghi

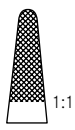
TUCARTK







MATHIEU

 1:1	 1:1	 1:1	 1:1
140 mm - 5½"	170 mm - 6¾"	200 mm - 8"	240 mm - 9½"
tk 20600-14 tucar	tk 20600-17 tucar	tk 20600-20 tucar	tk 20600-24 tucar

 1:1	 1:1
170 mm - 6¾"	200 mm - 8"
tk 20601-17 tucar	tk 20601-20 tucar

kräftiges Modell
heavy pattern
 modèle fort
 modelo fuerte
 modello forte

 1:1	 1:1	 1:1	 1:1
140 mm - 5½"	170 mm - 6¾"	200 mm - 8"	240 mm - 9½"
tk 20603-14 tucar	tk 20603-17 tucar	tk 20603-20 tucar	tk 20603-24 tucar

schlankes Modell
delicate pattern
 modèle fin
 modelo delicado
 modello delicato

Nadelhalter
Needle holders
Porte-aiguilles
Porta-agujas
Porta aghi

TUCAR^{TK}

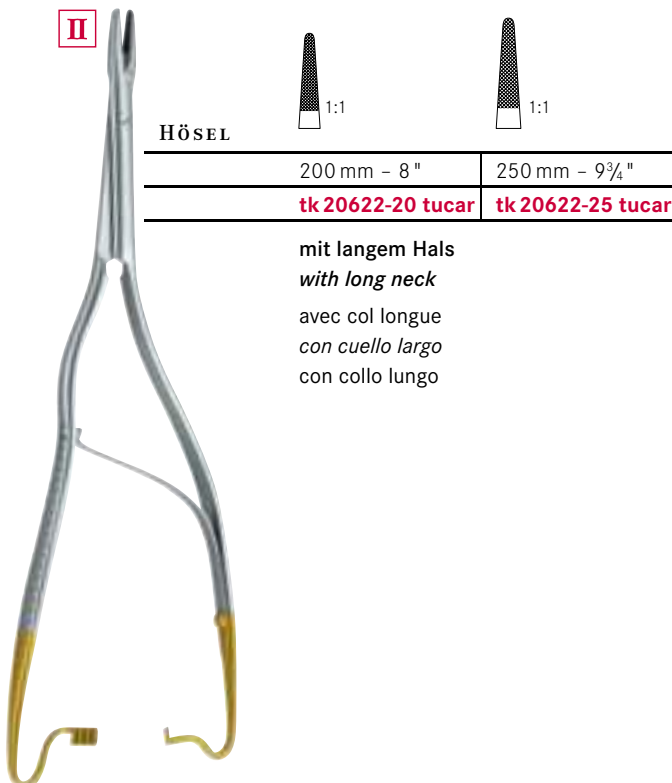
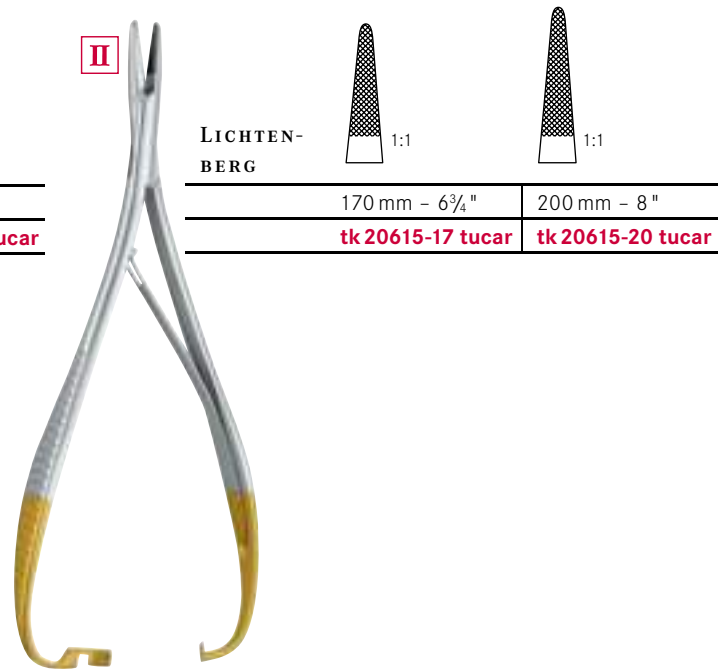
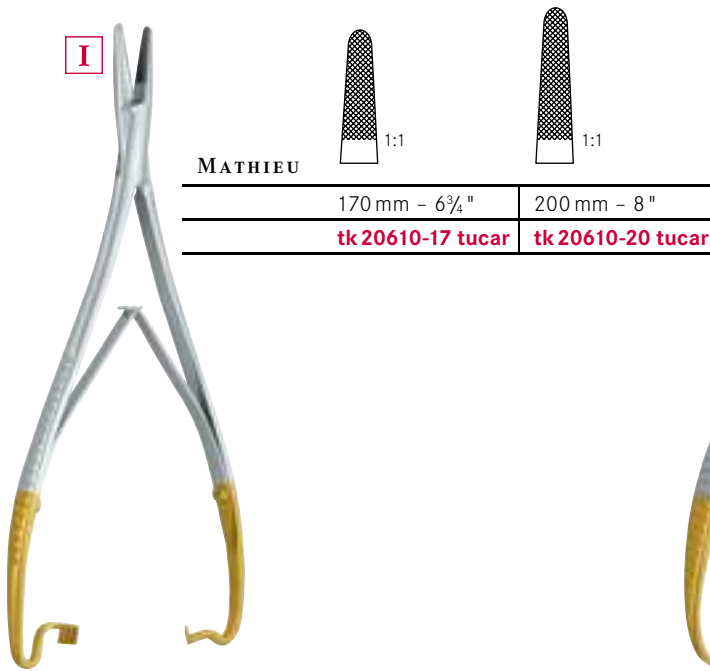

Nadelhalter | Porte-aiguilles
Needle holders | Porta-agujas
Porta aghi

TUCAR **TK**

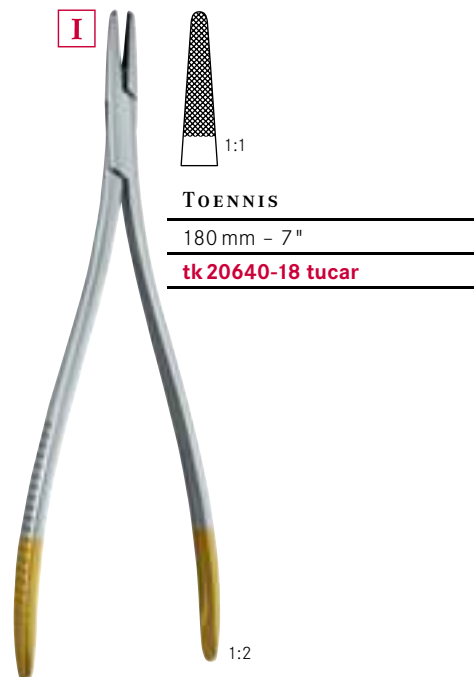
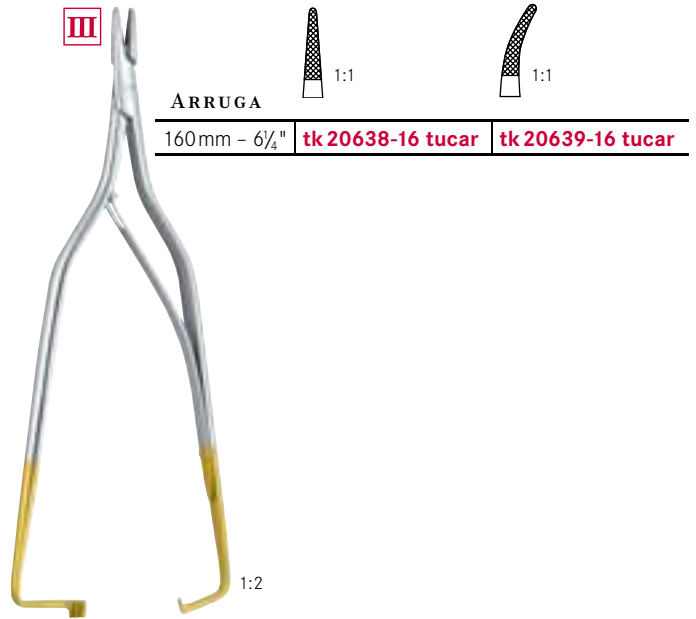
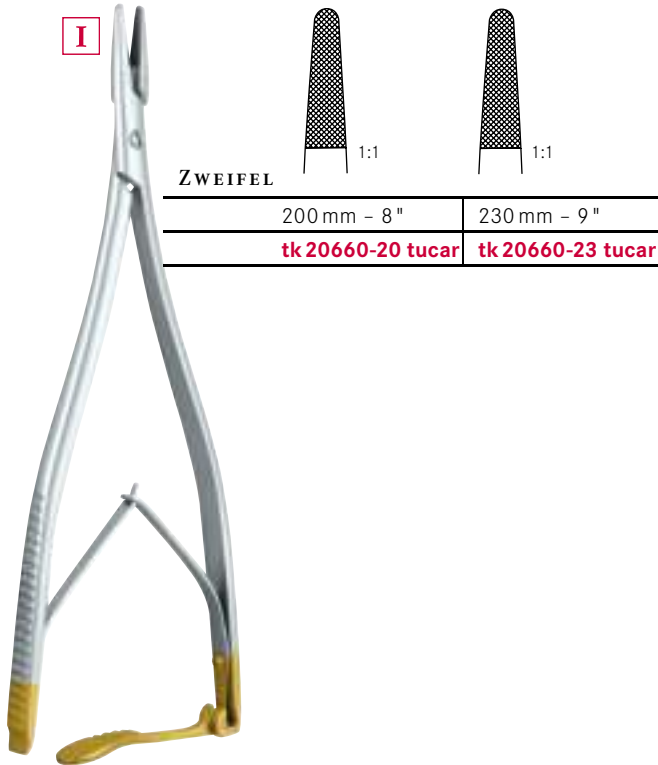



Nadelhalter
Needle holders
Porte-aiguilles
Porta-agujas
Porta aghi









II

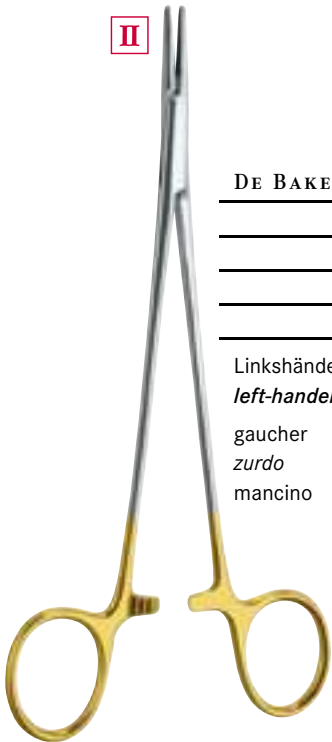

SAROT		
 1:1	 1:1	 1:1
180 mm - 7"	200 mm - 8"	260 mm - 10¼"
tk 20524-18 tucar	tk 20524-20 tucar	tk 20524-26 tucar

II





DE BAKEY				
 1:1	 1:1	 1:1	 1:1	 1:1
150 mm - 6"	180 mm - 7"	200 mm - 8"	230 mm - 9"	260 mm - 10¼"
tk 20522-15 tucar	tk 20522-18 tucar	tk 20522-20 tucar	tk 20522-23 tucar	tk 20522-26 tucar
tk 20522-15 LH	-	-	tk 20522-23 LH	tk 20522-26 LH

Linkshänder
left-hander
gaucher
zurdo
mancino

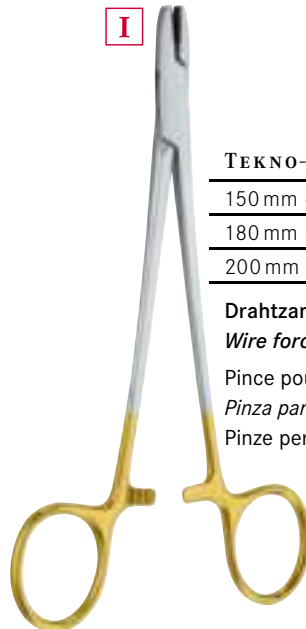
I



TEKNO-TWIST		
 1:1	 1:1	
150 mm - 6"	tk 20800-15 tucar	tk 20801-15 tucar
180 mm - 7"	tk 20800-18 tucar	tk 20801-18 tucar
200 mm - 8"	tk 20800-20 tucar	tk 20801-20 tucar

Drahtzange
Wire forceps
Pince pour fils d'acier
Pinza para hilos
Pinze per fili d'acciaio

Nadelhalter | Porte-aiguilles
 Needle holders | Porta-agujas
 Porta aghi

TUCAR^{TK}

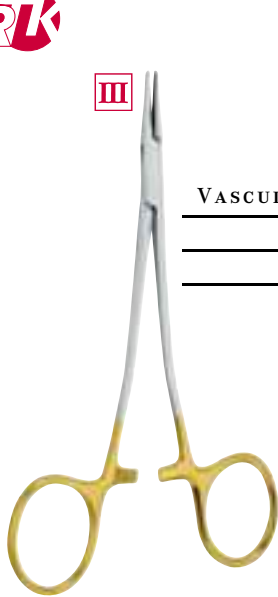

III

VASCULAR

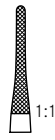

1:1



1:1



1:1



1:1

140 mm - 5½"	180 mm - 7"	200 mm - 8"	230 mm - 9"
tk 20525-14 tucar	tk 20525-18 tucar	tk 20525-20 tucar	tk 20525-23 tucar

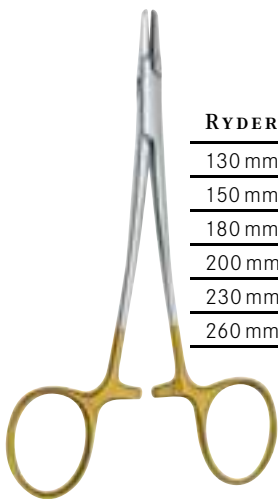

II

RYDER



130 mm - 5"	tk 20540-13 tucar
150 mm - 6"	tk 20540-15 tucar
180 mm - 7"	tk 20540-18 tucar
200 mm - 8"	tk 20540-20 tucar
230 mm - 9"	tk 20540-23 tucar
260 mm - 10¼"	tk 20540-26 tucar

III

MINI-RYDER



tk 20542-13 tucar
tk 20542-15 tucar
tk 20542-18 tucar
tk 20542-20 tucar
tk 20542-23 tucar
tk 20542-26 tucar



III



DIETRICH

160 mm - 6¼"	tk 20560-16 tucar
180 mm - 7"	tk 20560-18 tucar
200 mm - 8"	tk 20560-20 tucar
230 mm - 9"	tk 20560-23 tucar
250 mm - 9¾"	tk 20560-25 tucar

Nadelhalter
Needle holders
Porte-aiguilles
Porta-agujas
Porta aghi



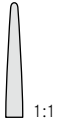
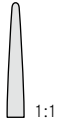
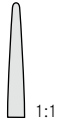

 1:1	 1:1	 1:1
130 mm - 5"	150 mm - 5¾"	170 mm - 6¾"
tk 20570-13	tk 20570-15	tk 20570-17

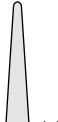
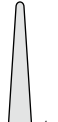
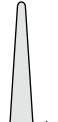
mit Spezialbeschichtung im Maul
with special coated jaw
mors avec couche special
boca con capa especial
morso con spalmatura speciale

 1:1	 1:1	 1:1
180 mm - 7"	200 mm - 8"	230 mm - 9"
tk 20570-18	tk 20570-20	tk 20570-23

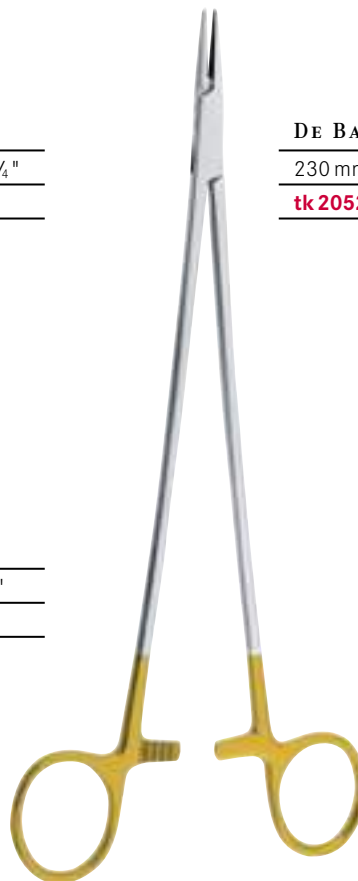
mit Spezialbeschichtung im Maul
with special coated jaw
mors avec couche special
boca con capa especial
morso con spalmatura speciale



 1:1
DE BAKEY
230 mm - 9"
tk 20522-23 SJ

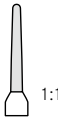

 1:1	
RYDER	
130 mm - 5"	tk 20541-13
150 mm - 6"	tk 20541-15
180 mm - 7"	tk 20541-18
200 mm - 8"	tk 20541-20
230 mm - 9"	tk 20541-23

mit Spezialbeschichtung im Maul
with special coated jaw
mors avec couche special
boca con capa especial
morso con spalmatura speciale

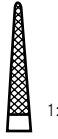

 1:1
DE BAKEY
180 mm - 7"
tk 20522-18 SJ

Nadelhalter | Porte-aiguilles
 Needle holders | Porta-agujas
 Porta aghi

TUCAR

IV



CASTROVIEJO-
JACOBSON



140 mm - 5½"		tk 20710-14 tucar		tk 20711-14 tucar
150 mm - 6"	tk 20704-15 tucar	tk 20710-15 tucar	tk 20705-15 tucar	tk 20711-15 tucar
180 mm - 7"	tk 20704-18 tucar	tk 20710-18 tucar	tk 20705-18 tucar	tk 20711-18 tucar
210 mm - 8¼"	tk 20704-21 tucar	tk 20710-21 tucar	tk 20705-21 tucar	tk 20711-21 tucar

glattes Maul
smooth jaws
mors lisse
boca lisa
morso liscio

gerade, ohne Sperre
straight, without ratchet
droit, sans crémaillère
recta, sin cremallera
retto, senza cremagliera

gerade, mit Sperre
straight, with ratchet
droit, avec crémaillère
recta, con cremallera
retto, con cremagliera

gebogen, ohne Sperre
curved, without ratchet
courbe, sans crémaillère
curva, sin cremallera
curvo, senza cremagliera

gebogen, mit Sperre
curved, with ratchet
courbe, avec crémaillère
curva, con cremallera
curvo, con cremagliera

III



VASCULAR



180 mm - 7"	tk 20716-18 tucar	tk 20714-18 tucar	tk 20717-18 tucar	tk 20715-18 tucar
-------------	-------------------	-------------------	-------------------	-------------------

gerade, ohne Sperre
straight, without ratchet
droit, sans crémaillère
recta, sin cremallera
retto, senza cremagliera

gerade, mit Sperre
straight, with ratchet
droit, avec crémaillère
recta, con cremallera
retto, con cremagliera

gebogen, ohne Sperre
curved, without ratchet
courbe, sans crémaillère
curva, sin cremallera
curvo, senza cremagliera

gebogen, mit Sperre
curved, with ratchet
courbe, avec crémaillère
curva, con cremallera
curvo, con cremagliera

1:2

Nadelhalter
Needle holders
Porte-aiguilles
Porta-agujas
Porta aghi



III



CASTROVIEJO

130 mm – 5"



tk 20728-13 tucar

gerade, gerieftes Maul
straight, serrated jaws

droit, mors strié
recta, boca estriada
retto, morso zigrinato



tk 20729-13 tucar

gebogen, gerieftes Maul
curved, serrated jaws

courbe, mors strié
curva, boca estriada
curvo, morso zigrinato

1:2

IV



CASTROVIEJO

130 mm – 5"

tk 20725-13 tucar

glattes Maul
smooth jaws

mors strié
boca lisa
morso liscio

1:2

IV



BARRAQUER

130 mm – 5"

tk 20731-13 tucar

gebogen, mit Sperre
curved, with ratchet
courbe, avec crémaillère
curva, con cremallera
curvo, con cremagliera



tk 20733-13 tucar

gebogen, ohne Sperre
curved, without ratchet
courbe, sans crémaillère
curva, sin cremallera
curvo, senza cremagliera

1:2

Nadelhalter | Porte-aiguilles
Needle holders | Porta-agujas
Porta aghi

TUCAR TK



BOYNTON
120 mm - 4¾"
tk 20750-12 tucar



KALT
140 mm - 5½"
tk 20760-14 tucar

Haut- und Muskelnadeln
Muscular and skin suture needles

Aiguilles pour sutures musculaires et cutanées
Agujas para suturas musculares y cutáneas
Aghi per muscoli e pelle

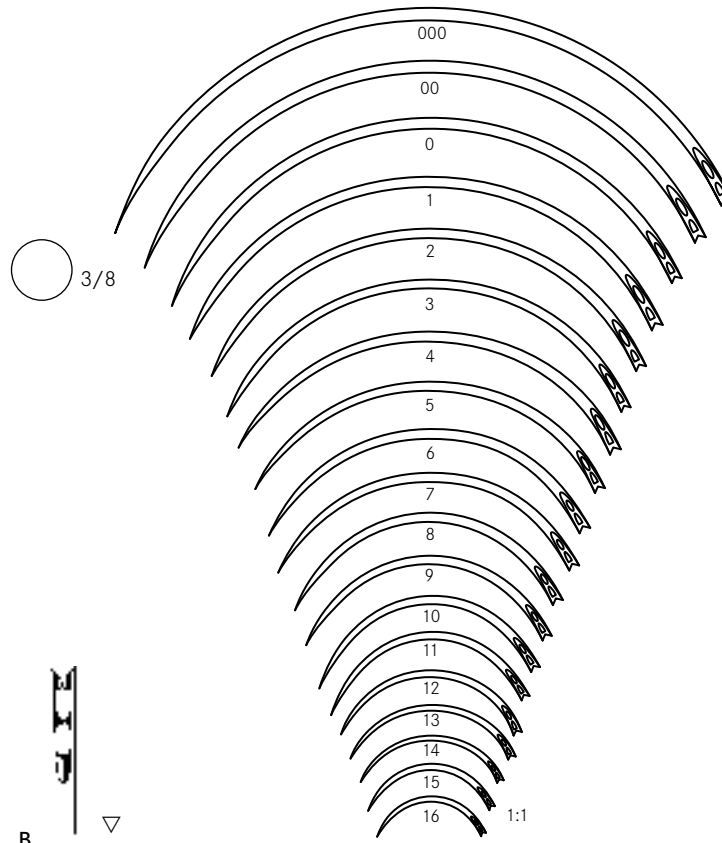

Fig. 000	Fig. 00	Fig. 0	Fig. 1	Fig. 2
tk 20905-30	tk 20905-20	tk 20905-00	tk 20905-01	tk 20905-02
Fig. 3	Fig. 4	Fig. 5	Fig. 6	Fig. 7
tk 20905-03	tk 20905-04	tk 20905-05	tk 20905-06	tk 20905-07
Fig. 8	Fig. 9	Fig. 10	Fig. 11	Fig. 12
tk 20905-08	tk 20905-09	tk 20905-10	tk 20905-11	tk 20905-12
Fig. 13	Fig. 14	Fig. 15	Fig. 16	
tk 20905-13	tk 20905-14	tk 20905-15	tk 20905-16	



Packung à 12 Stück
Package of 12 pieces
Paquet de 12 pièces
Paquete de 12 piezas
Confezione da 12 pezzi

Haut- und Muskelnadeln
Muscular and skin suture needles

Aiguilles pour sutures musculaires et cutanées
Agujas para suturas musculares y cutáneas
Aghi per muscoli e pelle

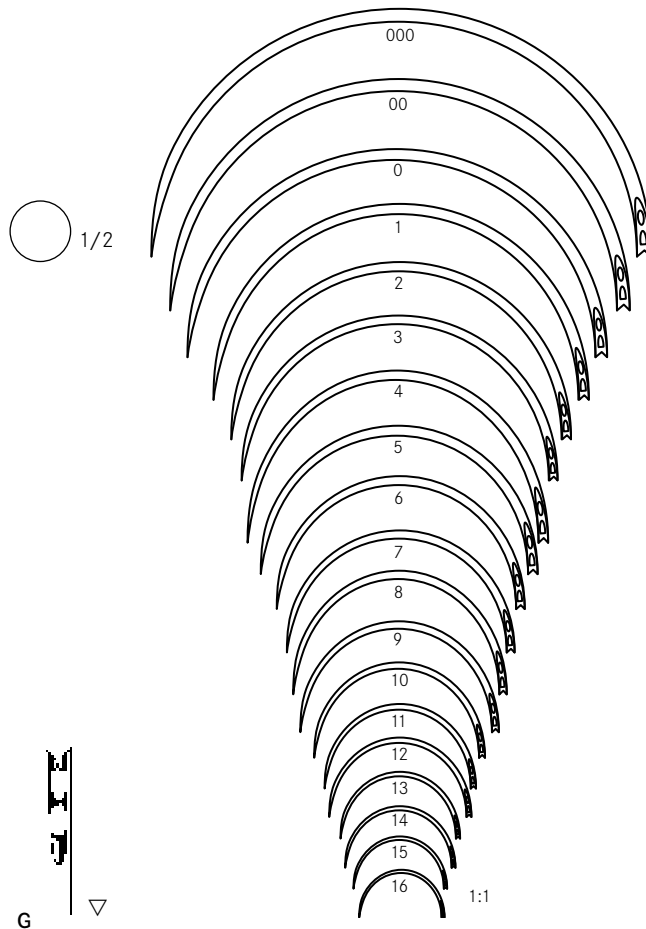

Fig. 000	Fig. 00	Fig. 0	Fig. 1	Fig. 2
tk 20910-30	tk 20910-20	tk 20910-00	tk 20910-01	tk 20910-02
Fig. 3	Fig. 4	Fig. 5	Fig. 6	Fig. 7
tk 20910-03	tk 20910-04	tk 20910-05	tk 20910-06	tk 20910-07
Fig. 8	Fig. 9	Fig. 10	Fig. 11	Fig. 12
tk 20910-08	tk 20910-09	tk 20910-10	tk 20910-11	tk 20910-12
Fig. 13	Fig. 14	Fig. 15	Fig. 16	
tk 20910-13	tk 20910-14	tk 20910-15	tk 20910-16	



Packung à 12 Stück
Package of 12 pieces
Paquet de 12 pièces
Paquete de 12 piezas
Confezione da 12 pezzi

Haut- und Muskelnadeln
Muscular and skin suture needles

Aiguilles pour sutures musculaires et cutanées
Agujas para suturas musculares y cutáneas
Aghi per muscoli e pelle

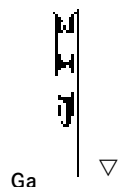
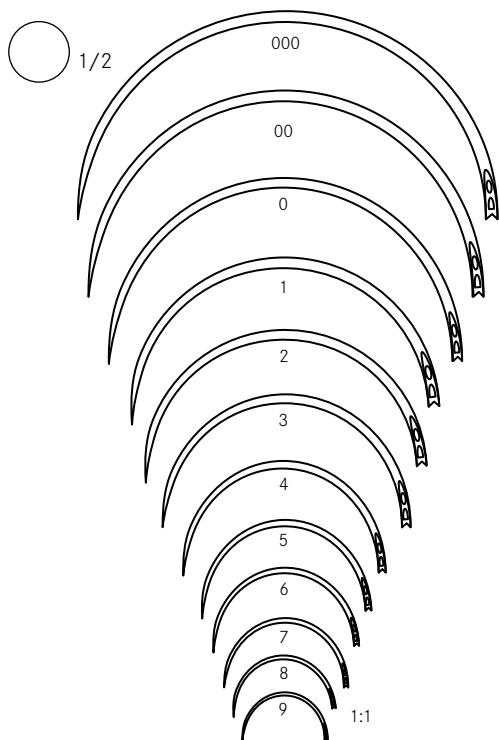

Fig. 000	Fig. 00	Fig. 0
tk 20916-30	tk 20916-20	tk 20916-00

Fig. 1	Fig. 2	Fig. 3
tk 20916-01	tk 20916-02	tk 20916-03

Fig. 4	Fig. 5	Fig. 6
tk 20916-04	tk 20916-05	tk 20916-06

Fig. 7	Fig. 8	Fig. 9
tk 20916-07	tk 20916-08	tk 20916-09

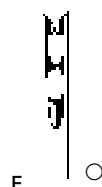
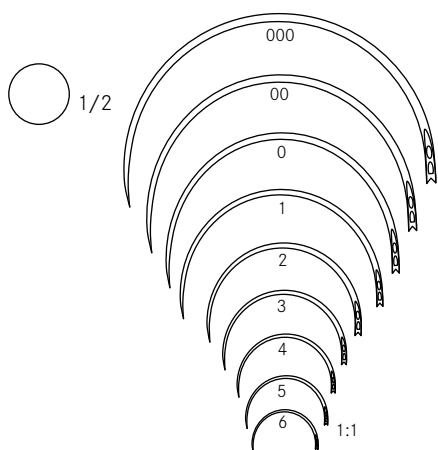

Fig. 000	Fig. 00	Fig. 0
tk 20924-30	tk 20924-20	tk 20924-10

Fig. 1	Fig. 2	Fig. 3
tk 20926-01	tk 20926-02	tk 20926-03

Fig. 4	Fig. 5	Fig. 6
tk 20926-04	tk 20926-05	tk 20926-06



Packung à 12 Stück
Package of 12 pieces
Paquet de 12 pièces
Paquete de 12 piezas
Confezione da 12 pezzi

Haut- und Muskelnadeln
Muscular and skin suture needles

Aiguilles pour sutures musculaires et cutanées
Agujas para suturas musculares y cutáneas
Aghi per muscoli e pelle

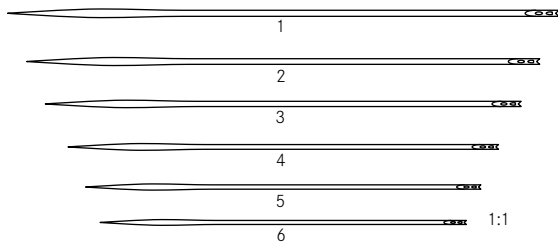

KEITH

Fig. 1	Fig. 2	Fig. 3
tk 20930-01	tk 20930-02	tk 20930-03

Fig. 4	Fig. 5	Fig. 6
tk 20930-04	tk 20930-05	tk 20930-06



Fig. 1	Fig. 2	Fig. 3
tk 20934-01	tk 20934-02	tk 20934-03

Fig. 4	Fig. 5	Fig. 6
tk 20934-04	tk 20934-05	tk 20934-06



Packung à 12 Stück
Package of 12 pieces
Paquet de 12 pièces
Paquete de 12 piezas
Confezione da 12 pezzi



Darmnadeln
Intestinal needles

Aguilles intestinales
Agujas intestinales
Aghi intestinali

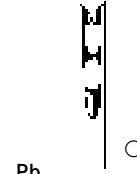
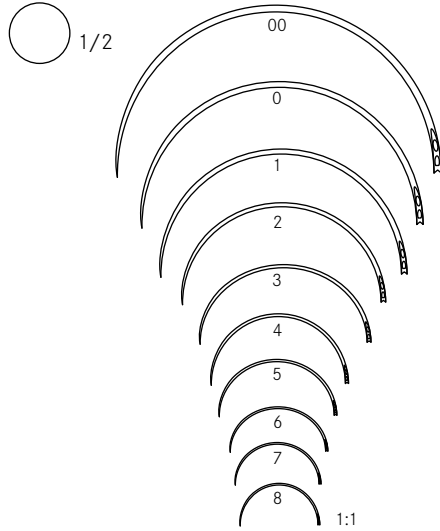

Fig. 00	Fig. 0	Fig. 1
tk 20936-20	tk 20936-10	tk 20938-01

Fig. 2	Fig. 3
tk 20938-02	tk 20938-03

Fig. 4	Fig. 5	Fig. 6
tk 20938-04	tk 20938-05	tk 20938-06

Fig. 7	Fig. 8
tk 20938-07	tk 20938-08

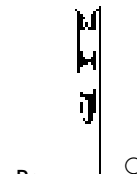
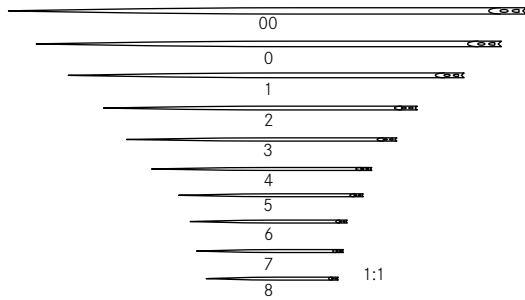

Fig. 00	Fig. 0	Fig. 1
tk 20940-20	tk 20940-10	tk 20942-01

Fig. 2	Fig. 3
tk 20942-02	tk 20942-03

Fig. 4	Fig. 5	Fig. 6
tk 20942-04	tk 20942-05	tk 20942-06

Fig. 7	Fig. 8
tk 20942-07	tk 20942-08



Packung à 12 Stück
Package of 12 pieces
Paquet de 12 pièces
Paquete de 12 piezas
Confezione da 12 pezzi

Darmnadeln | Aiguilles intestinales
Intestinal needles | *Agujas intestinales*
 Aghi intestinali

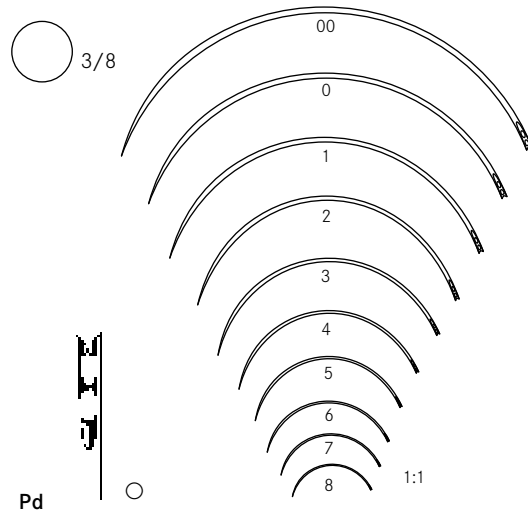

Fig. 00	Fig. 0	Fig. 1
tk 20944-20	tk 20944-10	tk 20946-01

Fig. 2	Fig. 3
tk 20946-02	tk 20946-03

Fig. 4	Fig. 5	Fig. 6
tk 20946-04	tk 20946-05	tk 20946-06

Fig. 7	Fig. 8
tk 20946-07	tk 20946-08



Packung à 12 Stück
 Package of 12 pieces

Paquet de 12 pièces
 Paquete de 12 piezas
 Confezione da 12 pezzi



Augennadeln | Aiguilles ophtalmiques
Eye needles | Aguja para suturas oculares
 Aghi oftalmici

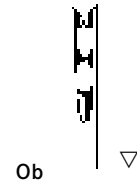
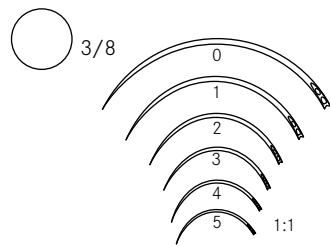

Ob

Fig. 0	Fig. 1	Fig. 2
tk 20948-00	tk 20948-01	tk 20948-02
Fig. 3	Fig. 4	Fig. 5
tk 20948-03	tk 20948-04	tk 20948-05

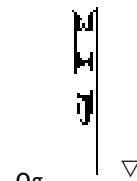
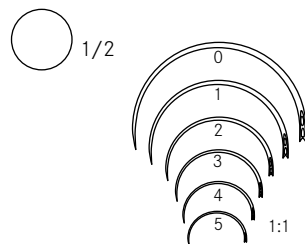

Og

Fig. 0	Fig. 1	Fig. 2
tk 20950-00	tk 20950-01	tk 20950-02
Fig. 3	Fig. 4	Fig. 5
tk 20950-03	tk 20950-04	tk 20950-05



Packung à 12 Stück
 Package of 12 pieces
 Paquet de 12 pièces
 Paquete de 12 piezas
 Confezione da 12 pezzi

Feine Nadeln | Aiguilles fines
Delicate needles | *Agujas finas*
 | *Aghi delicato*

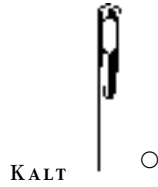
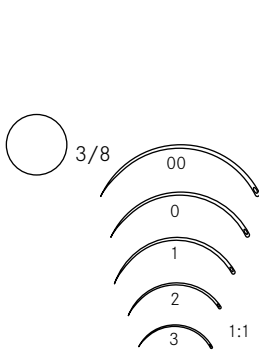

KALT

Fig. 00	Fig. 0	Fig. 1
tk 20957-20	tk 20957-10	tk 20958-01
Fig. 2	Fig. 3	
tk 20958-02	tk 20958-03	

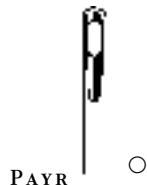
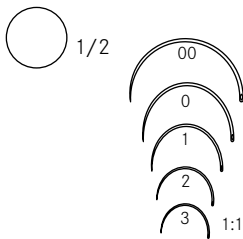

PAYR

Fig. 00	Fig. 0	Fig. 1
tk 20962-20	tk 20962-10	tk 20964-01
Fig. 2	Fig. 3	
tk 20964-02	tk 20964-03	

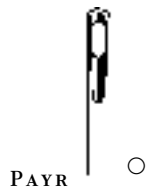
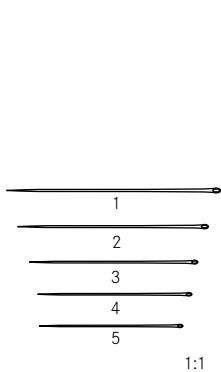

PAYR

Fig. 1	Fig. 2	Fig. 3
tk 20960-01	tk 20960-02	tk 20960-03
Fig. 4	Fig. 5	
tk 20960-04	tk 20960-05	



Packung à 12 Stück
Package of 12 pieces
 Paquet de 12 pièces
 Paquete de 12 piezas
 Confezione da 12 pezzi

Nahtinstrumente
Suture instruments

Instruments à suture
Instrumentos para sutura
Strumenti per sutura



REVERDIN

	Fig. 1	Fig. 2	Fig. 3	Fig. 4
150 mm - 6"	tk 21101-15	tk 21102-15	tk 21103-15	tk 21104-15
195 mm - 7¾"	tk 21101-19	tk 21102-19	tk 21103-19	tk 21104-19
225 mm - 8¾"	tk 21101-23	tk 21102-23	tk 21103-23	tk 21104-23



YOUNG

250mm - 9¾"
tk 21120-25

Komplett mit einem Nadelaufsatz
Complete with one needle
Complet avec une aiguille
Completo con una aguja
Completo con un ago

1:3

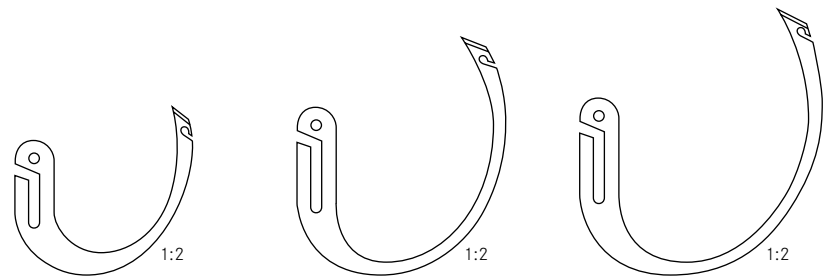

tk 21121-01	tk 21121-02	tk 21121-03
-------------	-------------	-------------

Ersatznadel
Spare needle
Aiguille de rechange
Aguja de cambio
Ago di ricambio

Nahtinstrumente
Suture instruments

Instruments à suture
Instrumentos para sutura
Strumenti per sutura



200 mm - 8"

tk 21142-20

biegsam

flexible

malléable

maleable

flessibile

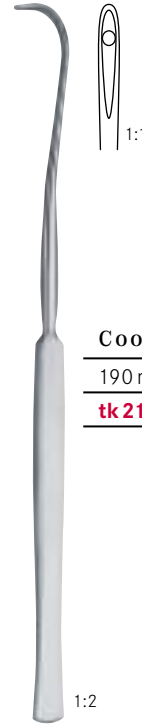

COOPER

190 mm - 7½"

tk 21144-19



KRONECKER

130 mm - 5"

tk 21146-13

tk 21147-13

für die rechte Hand
for right hand

für die linke Hand
for left hand

pour la main droite
para la mano derecha
per la mano destra

pour la main gauche
para la mano izquierda
per la mano sinistra

Unterbindungsnadeln | Aiguilles à suture
 Ligature needles | Agujas para sutura
 Aghi per sutura

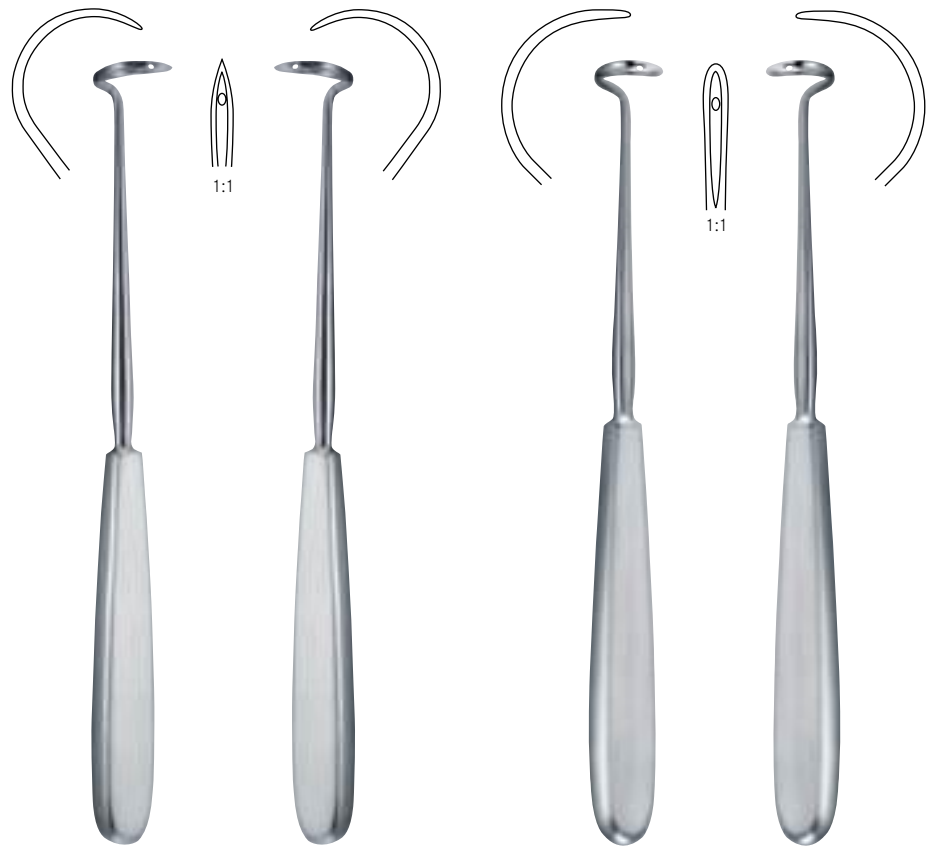

DESCHAMPS

200 mm - 8"	tk 21210-20	tk 21212-20	tk 21214-20	tk 21216-20
210 mm - 8¼"	tk 21210-21	tk 21212-21	tk 21214-21	tk 21216-21
270 mm - 10¾"	tk 21210-27	tk 21212-27	tk 21214-27	tk 21216-27

scharf
sharp
 pointue
aguda
acuta
 für die rechte Hand
for right hand
 pour la main droite
para la mano derecha
 per la mano destra

scharf
sharp
 pointue
aguda
acuta
 für die linke Hand
for left hand
 pour la main gauche
para la mano izquierda
 per la mano sinistra

stumpf
blunt
 mousse
roma
smussa
 für die rechte Hand
for right hand
 pour la main droite
para la mano derecha
 per la mano destra

stumpf
blunt
 mousse
roma
smussa
 für die linke Hand
for left hand
 pour la main gauche
para la mano izquierda
 per la mano sinistra

Nahtinstrumente
Suture instruments

Instruments à suture
Instrumentos para sutura
Strumenti per sutura



ROTTER

260 mm - 10 1/4"



tk 21220-01

für die rechte Hand
for right hand

pour la main droite
para la mano derecha
per la mano destra



tk 21221-01

für die linke Hand
for left hand

pour la main gauche
para la mano izquierda
per la mano sinistra

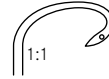

tk 21220-02

für die rechte Hand
for right hand

pour la main droite
para la mano derecha
per la mano destra



tk 21221-02

für die linke Hand
for left hand

pour la main gauche
para la mano izquierda
per la mano sinistra

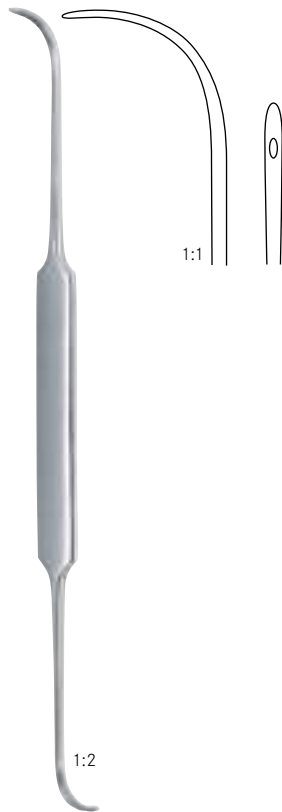

SCHMIEDEN

210 mm - 8 1/4"

tk 21217-22



CLAUS-EICKEN

230 mm - 9"

tk 21218-23



CLAUS

230 mm - 9"

tk 21219-23



Nahtinstrumente
Suture instruments

Instruments à suture
Instrumentos para sutura
Strumenti per sutura



HURD

210 mm - 8 1/4"

tk 21232-21

tk 21233-21

für die rechte Hand
for right hand

für die linke Hand
for left hand

pour la main droite
para la mano derecha
per la mano destra

pour la main gauche
para la mano izquierda
per la mano sinistra

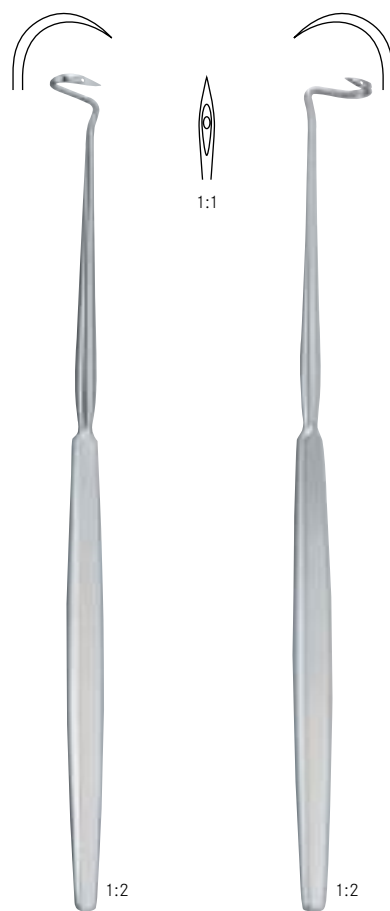

DUPUY-WEISS

220 mm - 8 3/4"

tk 21226-22

tk 21227-22

für die rechte Hand
for right hand

für die linke Hand
for left hand

pour la main droite
para la mano derecha
per la mano destra

pour la main gauche
para la mano izquierda
per la mano sinistra

Nahtinstrumente
Suture instruments

Instruments à suture
Instrumentos para sutura
Strumenti per sutura



YANKAUER

170 mm - 6³/₄"

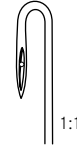

tk 21236-01

tk 21236-02

tk 21236-03

tk 21236-04

Septumnadeln
Septum suture needles

Aiguilles de sutures du septum
Agujas de sutura de septum
Aghi di sutura per setto

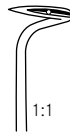

tk 21236-05

tk 21236-06

tk 21236-07

tk 21236-08

tk 21236-09



NAGER

240 mm - 9¹/₂"

tk 21229-24

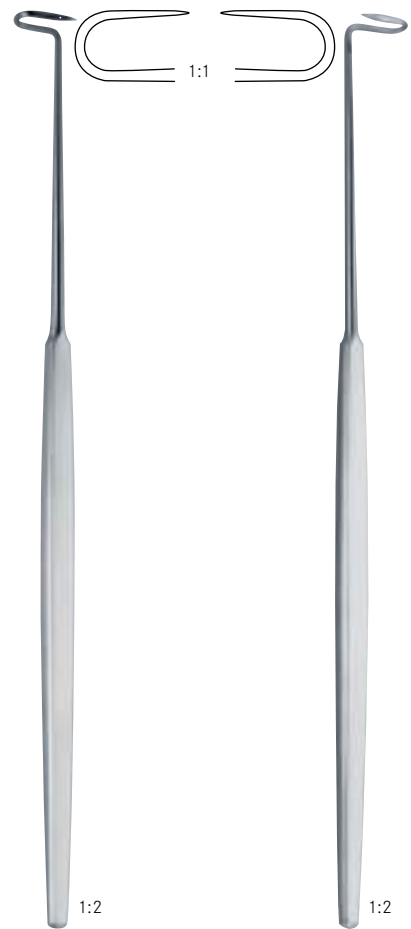

FALK

240 mm - 9¹/₂"

tk 21234-24

tk 21235-24

für die rechte Hand
for right hand

pour la main droite
para la mano derecha
per la mano destra

für die linke Hand
for left hand

pour la main gauche
para la mano izquierda
per la mano sinistra

Führungshohlsonden - Nahtinstrumente
Ligature conductors - Suture instruments

Sondes conductrices - Instruments à suture
Sondas conductoras - Instrumental para sutura
 Sonde conduttrici - Strumenti per sutura

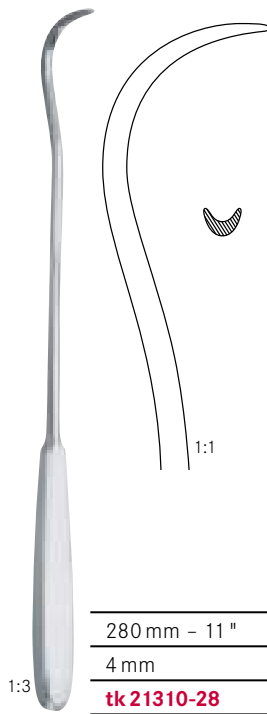

280 mm - 11"
4 mm
tk 21310-28

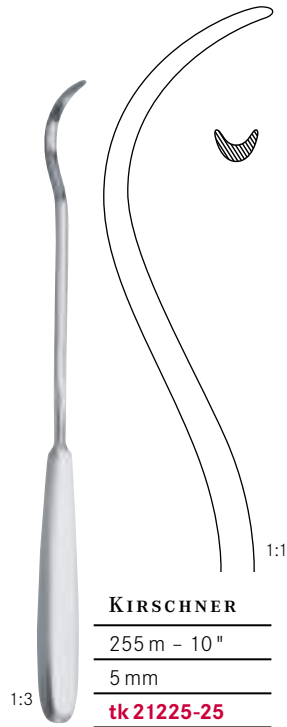

KIRSCHNER

255 m - 10"
5 mm
tk 21225-25

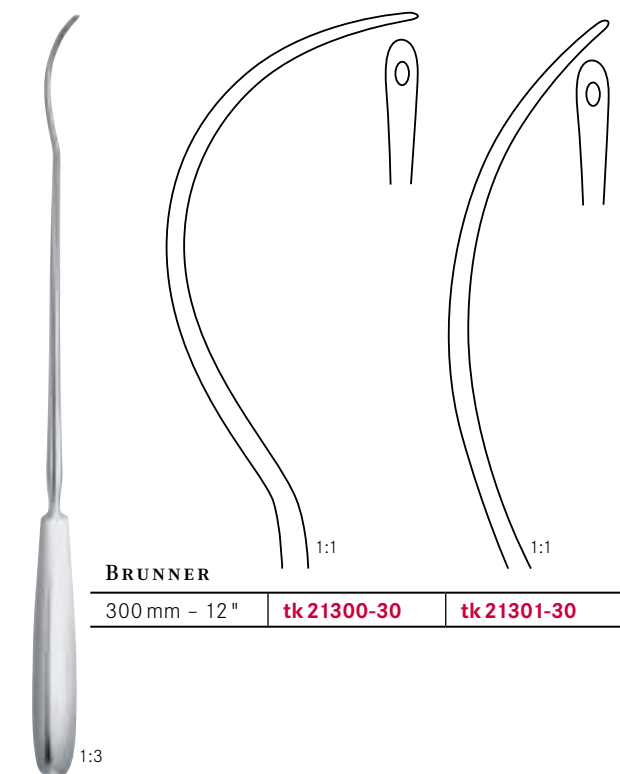

BRUNNER

300 mm - 12"	tk 21300-30	tk 21301-30
--------------	--------------------	--------------------

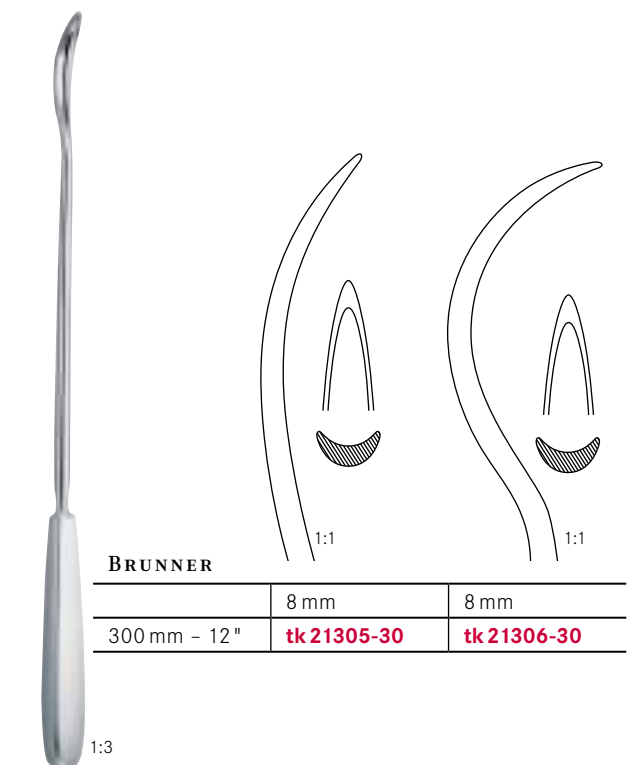

BRUNNER

	8 mm	8 mm
300 mm - 12"	tk 21305-30	tk 21306-30



Führungshohlsonden - Nahtinstrumente
Ligature conductors - Suture instruments

Sondes conductrices - Instruments à suture
Sondas conductoras - Instrumental para sutura
 Sonde conduttrici - Strumenti per sutura

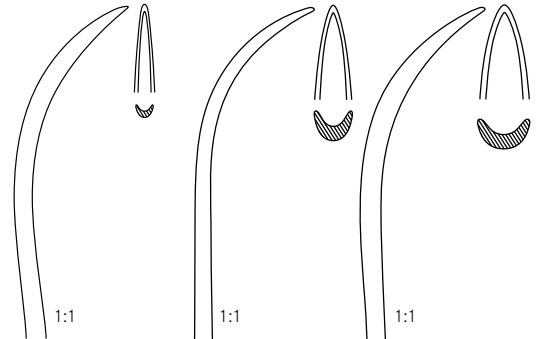

KÖNIG

	2.5 mm	5 mm	7 mm
190 mm - 7½"	tk 21355-03	tk 21355-05	
200 mm - 8"			tk 21355-07



BRUNNER

180 mm - 7"	tk 21320-18
270 mm - 10¾"	tk 21320-27

Ferrozell



1:2

KIRSCHNER

270 mm - 10¾"	tk 21325-27
---------------	--------------------

Ferrozell

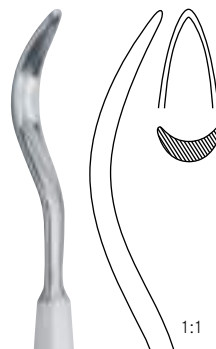

1:1

SCHMIEDEN

190 mm - 7½"	
8 mm	
tk 21345-19	

1:2



1:1

SCHMIEDEN-PAYR

190 mm - 7½"	
8 mm	
tk 21346-19	

1:2

Führungshohlsonden - Nahtinstrumente
 Ligature conductors - Suture instruments

Sondes conductrices - Instruments à suture
 Sondas conductoras - Instrumental para sutura
 Sonde conduttrici - Strumenti per sutura

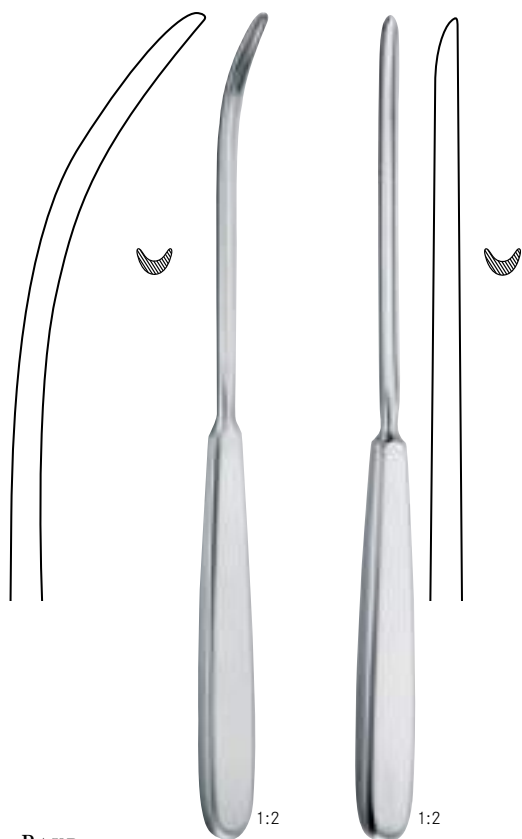

PAYR		
	5 mm	5 mm
220 mm - 8 ³ / ₄ "	tk 21365-22	tk 21366-22



MOD. WIEN
 235 mm - 9¹/₄"
 tk 21375-23

Fadenfänger
 Ligature catcher
 Porte-ligature
 Captador de hilos
 Portalegature



BOZEMANN
 210 mm - 8¹/₄"
 tk 21380-21

Schlingendreher
 Knot tier
 Tords-fil
 Tuerce-lazos
 Torcifilo



230 mm - 9"
 tk 21385-23

Fadengabel
 Ligature adjuster
 Pousse-fil
 Horquilla de hilos
 Forchetta da sutura

Klammernaht-Instrumente
Suture clip instruments

Instrumentos para suturas aux agrafes
Instrumentos para suturas con grapas
Strumenti per suture con agraiffe



CHILDE

180 mm - 7"

tk 21420-18

kräftig, mit Klammerschiene
heavy pattern, with clip holder
modèlo fort, avec porte-agrafe
modelo fuerte, con barra para agrafes
modello forte, con portaagrafes



MICHEL

120 mm - 4¾"

tk 21802-12



WACHENFELDT

125 mm - 5"

tk 21803-12

tk 21804-12



HEGENBARTH

125 mm - 5"

tk 21805-12



COLLIN

130 mm - 5"

tk 21806-13



RICHTER-HEATH

140 mm - 5½"

tk 21807-13



MICHEL

120 mm - 4¾"

tk 21812-12



Gefäßchirurgie
Vascular surgery

Chirurgie vasculaire
Cirurgía vascular
Chirurgia vascolare



Gefäßstripper
Vein stripper

Tire-veines
Fleboextractores
Tiravene



	○ 1:1	○ 1:1	○ 1:1	○ 1:1	○ 1:1
	2 mm Ø	3 mm Ø	4 mm Ø	5 mm Ø	6 mm Ø
500 mm - 20"	tk 18147-02	tk 18147-03	tk 18147-04	tk 18147-06	tk 18147-07

	○ 1:1	○ 1:1	○ 1:1	○ 1:1
	8.5 mm Ø	10 mm Ø	12 mm Ø	14 mm Ø
500 mm - 20"	tk 18147-08	tk 18147-10	tk 18147-12	tk 18147-14



120 mm - 4 3/4" **tk 18147-30**

Griff für tk 18147-02 - tk 18147-14
Handle for tk 18147-02 - tk 18147-14

Manche pour tk 18147-02 - tk 18147-14
Mango para tk 18147-02 - tk 18147-14
Manico per tk 18147-02 - tk 18147-14

1:2



1:2

RUMEL-BELMONT

	3.2 mm Ø	6.4 mm Ø
325 mm - 12 3/4"	tk 24845-32	tk 24845-64

Tourniquet	für Kinder	für Erwachsene
Tourniquet	for children	for adults
Tourniquet	pour enfants	pour adultes
Tourniquete	para niños	para adultos
Tourniquet	per bambini	per adulti

Krampfaderbesteck
Varicose vein probe set

Trousse à varices
Juego para várices
 Astuccio per varici



1:2

NABATOFF

135 mm x 100 mm x 25 mm

tk 18145-00

komplett
complete
 complet
completo

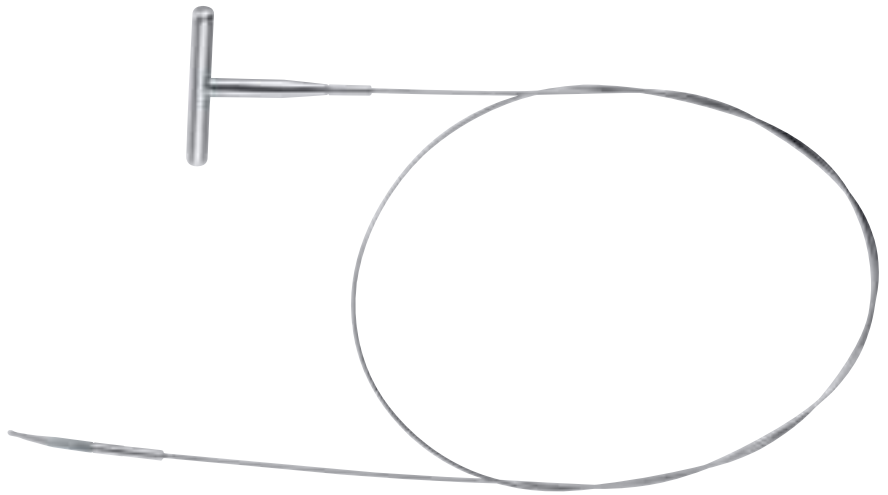

1:1



1:1



1:1



1:1

3 mm Ø

6 mm Ø

9 mm Ø

12 mm Ø

tk 18145-95	tk 18145-80	tk 18145-90	tk 18145-02
Metalletui <i>Metal case</i>	Griff <i>Handle</i>	Zugseil 900 mm <i>Cable 900mm</i>	Sondenspitze, Kunststoff <i>Probe tip in plastic</i>
Boîte métal <i>Estuche</i>	Manche <i>Mango</i>	Corde à traction 900 mm <i>Cordón 900mm</i>	Sonde en plastique <i>Extremidad de sonda, plastica</i>
Astuccio	Manico	Fune di trazione 900 mm	Punta di plastica



1:1



1:1



1:1



1:1



1:1

3 mm Ø

6 mm Ø

9 mm Ø

12 mm Ø

15 mm Ø

tk 18145-03

tk 18145-06

tk 18145-09

tk 18145-12

tk 18145-15

Sonde
Probe
 Sonde
Sonda
 Sonda

Olive
Olive
 Olive
Oliva
 Oliva

Approximatoren, Gefäßclips nach Biemer
Approximators, Biemer clips

Approximateurs, clips selon Biemer
Approximadores, Biemer clips
Approssimatori, clips vascolari Biemer



1:3

BIEMER

tk 25209-02

Anlegepinzette mit Schloss
applying forceps with lock

pince à poser avec verrou
aplicadora con cierre
pinza posa clips con cremagliera

tk 25209-01

Anlegepinzette ohne Schloss
applying forceps without lock

pince à poser sans verrou
aplicadora sin cierre
pinza posa clips senza cremagliera



x	y	gms
Maullänge <i>jaw length</i> longueur du mors <i>longitud de la boca</i> lunghezza del morso	max. Maulöffnung <i>max. jaw opening</i> ouverture max. du mors <i>apertura max. de la boca</i> apertura mass.	Schließkraft <i>closing pressure</i> force de fermeture <i>fuerza de cierre</i> pressione

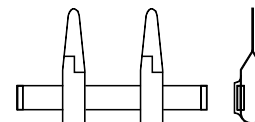
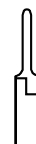
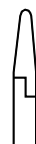
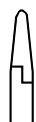

tk 25210-00

tk 25211-00

tk 25212-00

tk 25213-00

x = 6 mm
y = 4 mm
gms = 30-40

x = 9 mm
y = 5 mm
gms = 30-40

x = 9 mm
y = 5 mm
gms = 20-25

x = 4.5 mm
y = 3.0 mm
gms = 30-40

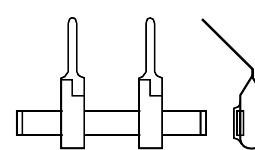
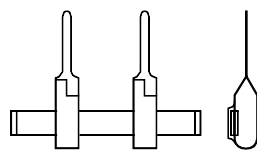
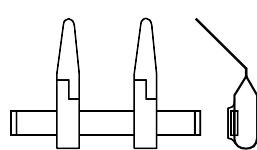
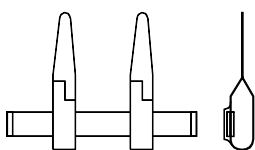

tk 25214-00

tk 25215-00

tk 25216-00

tk 25217-00

x = 9 mm
y = 5 mm
gms = 30-40

x = 9 mm
y = 5 mm
gms = 30-40

x = 9 mm
y = 5 mm
gms = 20-25

x = 9 mm
y = 5 mm
gms = 30-40

Für temporären Gebrauch, (gekennzeichnet durch gelb eingefärbte Federenden) für Gefäße mit 0,5 mm – 2,0 mm Ø. Maulinnenflächen schräg gerieft für schonendes und sicheres Festhalten der Gefäße. Der fest eingestellte Schließdruck gewährt risikofreie Anwendung.

For temporary occlusion, (identified by yellow coloured spring ends) for vessels of 0,5 mm – 2,0 mm Ø. Blade gripping surface with oblique serrations for save but careful gripping of vessels. No risk due to rigidly fixed pressure measure.

Pour usage temporaire, (ressorts couleur jaune) pour vaisseaux de 0,5 mm – 2,0 mm Ø. Mors striés pour fixation sûr et menagement. Force du fermeture non changeable.

Para oclusión temporal (ressortes amarillos) para vasos de 0,5 mm – 2,0 mm Ø. Boca estriada para fijación segura y moderada de los vasos. Utilización sin riesgo con fuerza de oclusión fijo.

Per uso temporaneo, con finale della molla giallo, per vasi di 0,5 mm – 2,0 mm Ø. Morso zigrinato per una presa sicura, non traumatica.

Anlegepinzetten für Gefäßclips
Applying forceps for vessel clips

Pinces à poser des clips
Aplicadoras para clips
 Pinze per mettere clips



140 mm – 5½" **tk 25059-01** **tk 25059-02**

140 mm – 5½" **tk 25059-03**

mit Schloß
with lock
 avec serrure
con cierre
 con cremagliera

für Approximatoren und Doppelklemmen
for approximators and double-clips
 pour approximateurs et clips doubles
para aproximadores y clips dobles
 per approssimatori e clips doppi

für Clips tk 25060-01 bis tk 27075-04
for clips tk 25060-01 to tk 27075-04
 pour clips tk 25060-01 a tk 27075-04
para clips tk 25060-01 a tk 27075-04
 per clips tk 25060-01 a tk 27075-04



x	Ø	V	A
Länge <i>Length</i>	Gefäß <i>Vessel</i>	Vene <i>Vein</i>	Arterie <i>Artery</i>
Longueur <i>Longitud</i>	Vaisseau <i>Vaso</i>	Veine <i>Vena</i>	Artère <i>Arteria</i>
Lunghezza	Vaso	Vena	Arteria







Weitere Modelle und Ausführungen auf Anfrage.
Other models and executions upon request.

Autres modèles et exécutions sur demande.
Otros modelos y ejecuciones segun demanda.
 Altri modelli a richiesta.

Approximatoren, Gefäßclips
Approximators, clips

Approximateurs, clips
Approximadores, clips
Approssimatori, clips vascolari



x = 8 mm

V	tk 25060-01	tk 25060-02	tk 25060-03	tk 25060-04
A	tk 25070-01	tk 25070-02	tk 25070-03	tk 25070-04

Ø = 0,4 mm - 1 mm

x = 11 mm

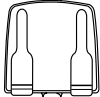
V	tk 25061-01	tk 25061-02	tk 25061-03	tk 25061-04
A	tk 25071-01	tk 25071-02	tk 25071-03	tk 25071-04

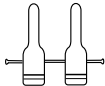
Ø = 0,6 mm - 1,5 mm

x = 14 mm

V	tk 25062-01	tk 25062-02	tk 25062-03	tk 25062-04
A	tk 25072-01	tk 25072-02	tk 25072-03	tk 25072-04

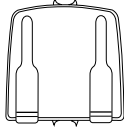
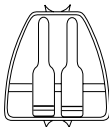
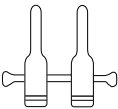
Ø = 1 mm - 2 mm

x = 17 mm

V	tk 25063-01	tk 25063-02	tk 25063-03	tk 25063-04
A	tk 25073-01	tk 25073-02	tk 25073-03	tk 25073-04

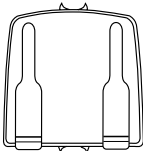
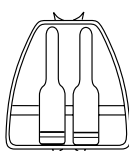
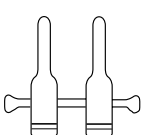
Ø = 1 mm - 2,25 mm

x = 25 mm

V	tk 25064-01	tk 25064-02	tk 25064-03	tk 25064-04
A	tk 25074-01	tk 25074-02	tk 25074-03	tk 25074-04

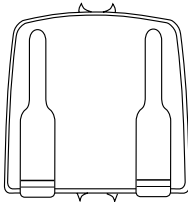
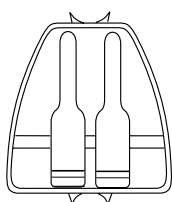
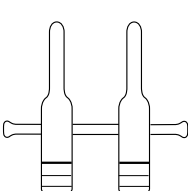
Ø = 1,5 mm - 3,5 mm

x = 36 mm

V	tk 25065-01	tk 25065-02	tk 25065-03	tk 25065-04
A	tk 25075-01	tk 25075-02	tk 25075-03	tk 25075-04

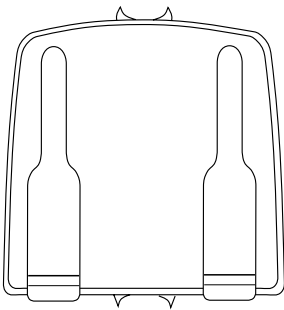
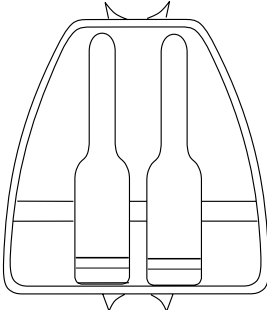
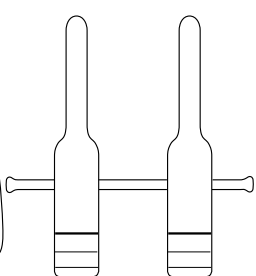
Ø = 1,5 mm - 3,5 mm

Mikro-Gefäßclips | Micro clips pour vaisseaux
Micro vessel-clips | *Micro clips para vasos*
 Micro clips per vasi

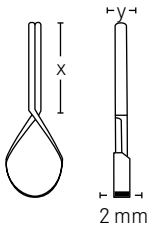

x = Maullänge x = <i>Jaw length</i>	y = max. Maulöffnung y = <i>max. opening</i>	gms = Schließkraft gms = <i>Pressure</i>
x = Longueur du mors x = <i>Longitud de la boca</i>	y = Ouverture max. du mors y = <i>Apertura max. de la boca</i>	gms = Force de fermeture gms = <i>Presión</i>
x = Lunghezza del morso	y = Apertura mass. del morso	gms = Sforza della chiusura

für temporären Verschluss
for temporary closure
 pour fermeture temporaire
para oclusión temporal
 per chiusura temporanea

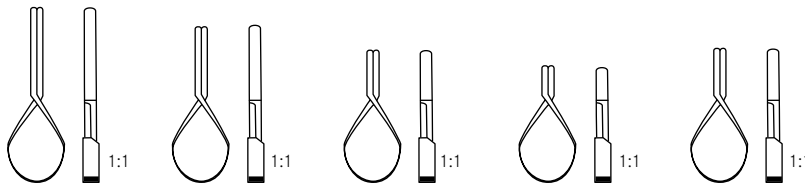

x = 10.0 mm	x = 8.0 mm	x = 6.0 mm	x = 4.0 mm	x = 6.0 mm
y = 1.5 mm	y = 1.0 mm	y = 0.8 mm	y = 0.75 mm	y = 1.0 mm
gms = 70	gms = 70	gms = 70	gms = 70	gms = 70
tk 25723-01	tk 25723-02	tk 25723-03	tk 25723-04	tk 25723-05

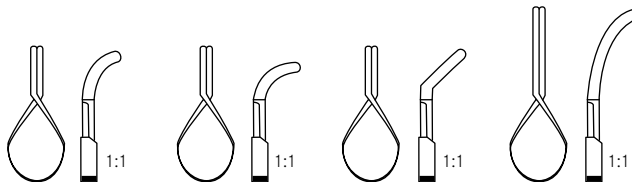

x = 6.0 mm	x = 6.0 mm	x = 6.0 mm	x = 10.0 mm
y = 1.0 mm	y = 1.0 mm	y = 1.0 mm	y = 1.0 mm
gms = 70	gms = 70	gms = 70	gms = 70
tk 25724-01	tk 25724-02	tk 25724-03	tk 25724-04



150 mm – 6" **tk 25720-13**

mit Sperre
with ratchet
 avec crémaillère
con cierre
 con cremagliera

180 mm – 7" **tk 25722-18**

mit Sperre, bajonettförmig
with ratchet, bayonet shaped
 avec crémaillère, en forme de baionette
con cierre, en forma de bayoneta
 con cremagliera, a forma baionetta

für Clips tk 25723-01 bis tk 25726-04
for clips tk 25723-01 to tk 25726-04
 pour clips tk 25723-01 a tk 25726-04
para clips tk 25723-01 a tk 25726-04
 per clips tk 25723-01 a tk 25726-04

Mikro-Gefäßclips
Micro vessel-clips

Micro clips pour vaisseaux
Micro clips para vasos
Micro clips per vasi

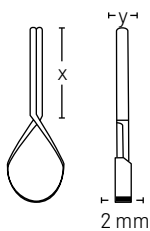

x = Maullänge	y = max. Maulöffnung	gms = Schließkraft
x = Jaw length	y = max. opening	gms = Pressure
x = Longueur du mors	y = Ouverture max. du mors	gms = Force de fermeture
x = Longitud de la boca	y = Apertura max. de la boca	gms = Presión
x = Lunghezza del morso	y = Apertura mass. del morso	gms = Sforza della chiusura

für temporären Verschluss
for temporary closure

pour fermeture temporaire
para oclusión temporal
per chiusura temporanea

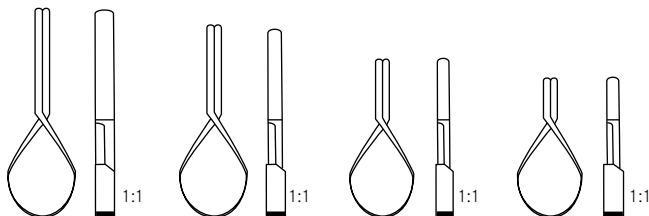

x = 10.0 mm	x = 8.0 mm	x = 6.0 mm	x = 4.0 mm
y = 2.0 mm	y = 2.0 mm	y = 1.0 mm	y = 0.75 mm
gms = 150	gms = 150	gms = 150	gms = 150
tk 25725-01	tk 25725-02	tk 25725-03	tk 25725-04

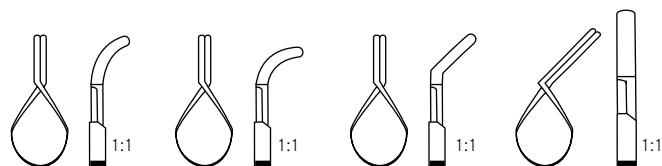

x = 6.0 mm	x = 6.0 mm	x = 6.0 mm	x = 8.0 mm
y = 1.0 mm	y = 1.0 mm	y = 1.0 mm	y = 2.0 mm
gms = 150	gms = 150	gms = 150	gms = 150
tk 25726-01	tk 25726-02	tk 25726-03	tk 25726-04

Bulldogklemmen
Bulldog clamps

Clamps Bulldog
Clamps Bulldog
Pinze Bulldog



JOHNS HOPKINS							
	38 mm – 1½"	50 mm – 2"	55 mm – 2¼"	65 mm – 2½"	70 mm – 2¾"	75 mm – 3"	90 mm – 3½"
	tk 11946-38	tk 11946-50	tk 11946-55	tk 11946-65	tk 11946-70	tk 11946-75	tk 11946-90

JOHNS HOPKINS							
	38 mm – 1½"	50 mm – 2"	55 mm – 2¼"	65 mm – 2½"	70 mm – 2¾"	75 mm – 3"	90 mm – 3½"
	tk 11947-38	tk 11947-50	tk 11947-55	tk 11947-65	tk 11947-70	tk 11947-75	tk 11947-90



235 mm – 9¼"
tk 11948-23

Anlegezange für Bulldogklemmen
Applying forceps for Bulldog clamps
Pince pour poser les clamps Bulldog
Pinza applicadora para clamps Bulldog
Pinza per posizionare le pinze Bulldog

1:2

Bulldogklemmen
Bulldog clamps

Clamps Bulldog
Clamps Bulldog
Pinze Bulldog



1:1

DIETRICH

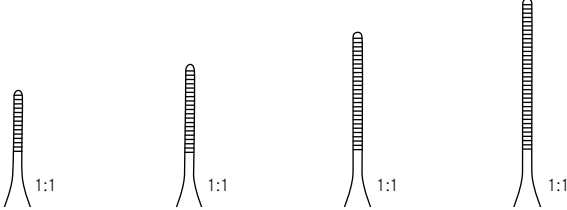

	8 mm	12 mm	16 mm	20 mm
50 mm - 2"	tk 11940-08	tk 11940-12	tk 11940-16	tk 11940-20



1:1

DIETRICH

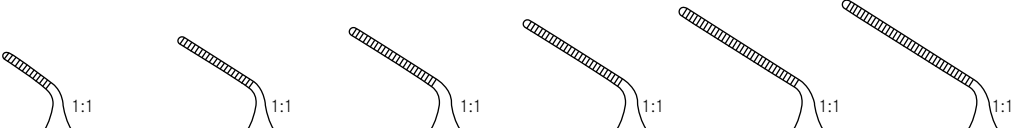

	8 mm	12 mm	13 mm	16 mm	18 mm	20 mm
50 mm - 2"	tk 11941-08	tk 11941-12	tk 11941-13	tk 11941-16	tk 11941-18	tk 11941-20

Bulldogklemmen | Clamps Bulldog
Bulldog clamps | *Clamps Bulldog*
 Pinze Bulldog

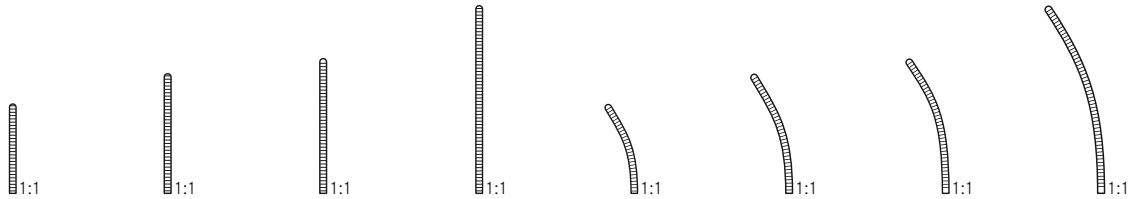

MINI - GLOVER

x =	30 mm - 1¼"	35 mm - 1½"	40 mm - 1½"	50 mm - 2"	30 mm - 1¼"	35 mm - 1½"	40 mm - 1½"	50 mm - 2"
y =	11 mm	15 mm	17 mm	24 mm	11 mm	15 mm	17 mm	24 mm
for Veins	gms = 110							
for Arteries	gms = 220							
for Veins	tk 11933-01	tk 11933-02	tk 11933-03	tk 11933-04	tk 11933-05	tk 11933-06	tk 11933-07	tk 11933-08
for Arteries	tk 11934-01	tk 11934-02	tk 11934-03	tk 11934-04	tk 11934-05	tk 11934-06	tk 11934-07	tk 11934-08



x = Länge **y = geriefte Maullänge** **gms = Schließkraft**
Length *serated jaw part* *closing force*
 Longueur partie striée du mors force de fermeture
 Longitud parte estriada de la boca presión
 Lunghezza morso zigrinato pressione di chiusura

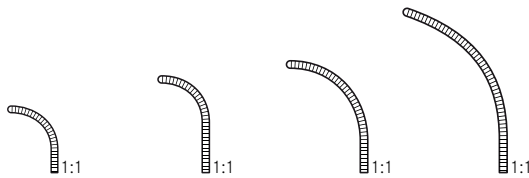

MINI - GLOVER

x =	30 mm - 1¼"	35 mm - 1½"	40 mm - 1½"	50 mm - 2"
y =	11 mm	15 mm	17 mm	24 mm
for Veins	gms = 110			
for Arteries	gms = 220			
for Veins	tk 11933-09	tk 11933-10	tk 11933-11	tk 11933-12
for Arteries	tk 11934-09	tk 11934-10	tk 11934-11	tk 11934-12



x = Länge **y = geriefte Maullänge** **gms = Schließkraft**
Length *serated jaw part* *closing force*
 Longueur partie striée du mors force de fermeture
 Longitud parte estriada de la boca presión
 Lunghezza morso zigrinato pressione di chiusura



230 mm - 9" / stainless steel

tk 11935-00

Anlegezange für Mini-Glover Bulldogklemmen
Applying forceps for Mini-Glover bulldog clamps

Pince á poser pour les clamps Bulldog (Mini-Glover)
 Aplicadora para clamps Bulldog (Mini-Glover)
 Pinza per posizionare le pinze Bulldog (Mini-Glover)

Bulldogklemmen
Bulldog clamps

Clamps Bulldog
Clamps Bulldog
Pinze Bulldog

ATRAUMTK

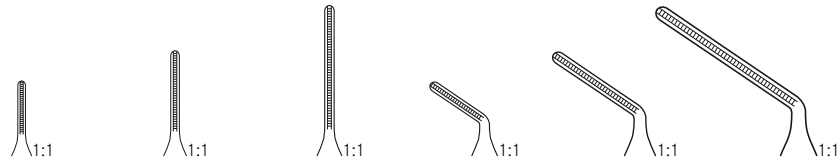
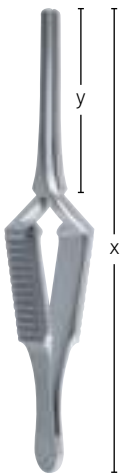

DE BAKEY - DIETHRICH

x =	49 mm - 2"	53 mm - 2"	59 mm - 2¼"	44 mm - 1¾"	46 mm - 1¾"	49 mm - 2"
y =	10 mm	14 mm	20 mm	10 mm	14 mm	20 mm
	gms = 180					
	tk 11949-01	tk 11949-02	tk 11949-03	tk 11949-04	tk 11949-05	tk 11949-06

x = Länge	y = geriefte Maullänge	gms = Schließkraft
Length	serated jaw part	closing force
Longueur	partie striée du mors	force de fermeture
Longitud	parte estriada de la boca	presión
Lunghezza	morso zigrinato	pressione di chiusura

Bulldogklemmen
Bulldog clamps

Clamps Bulldog
Clamps Bulldog
Pinze Bulldog

ATRAUMTK

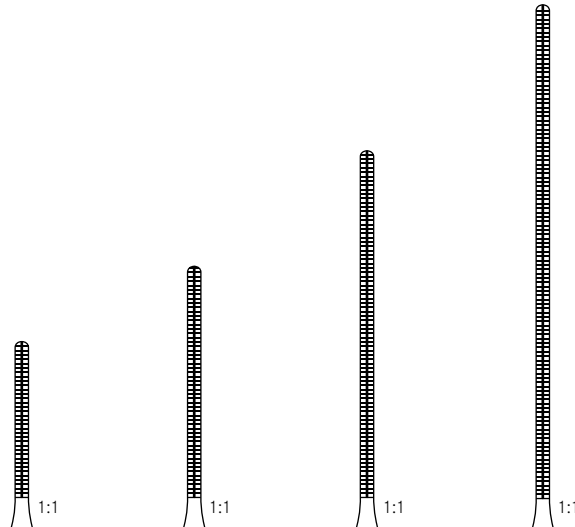

COOLEY

80 mm - 3 1/4"	90 mm - 3 1/2"	105 mm - 4 1/4"	125 mm - 5"
tk 11942-08	tk 11942-09	tk 11942-10	tk 11942-12

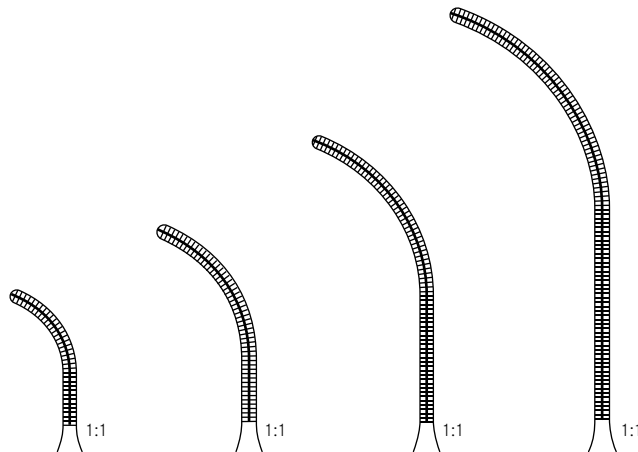

COOLEY

75 mm - 3"	85 mm - 3 1/4"	95 mm - 3 3/4"	115 mm - 4 1/2"
tk 11943-07	tk 11943-08	tk 11943-09	tk 11943-11

Bulldogklemmen
Bulldog clamps

Clamps Bulldog
Clamps Bulldog
Pinze Bulldog

ATRAUMTK



DE BAKEY

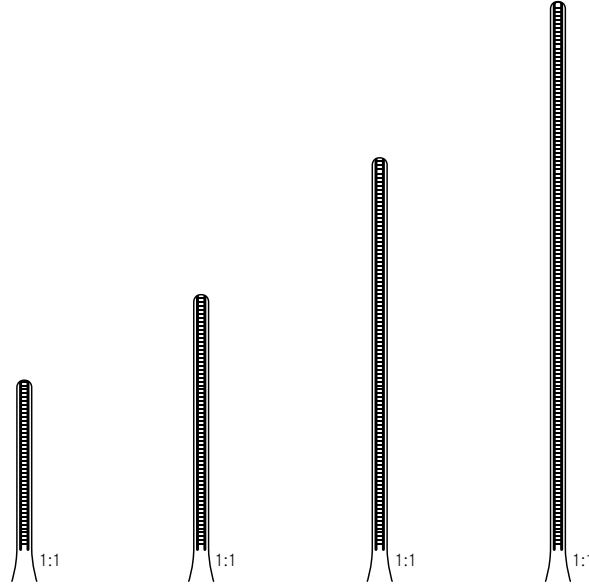

75 mm - 3"	85 mm - 3 1/4"	105 mm - 4 1/4"	120 mm - 4 3/4"
tk 11950-08	tk 11950-09	tk 11950-10	tk 11950-12



DE BAKEY

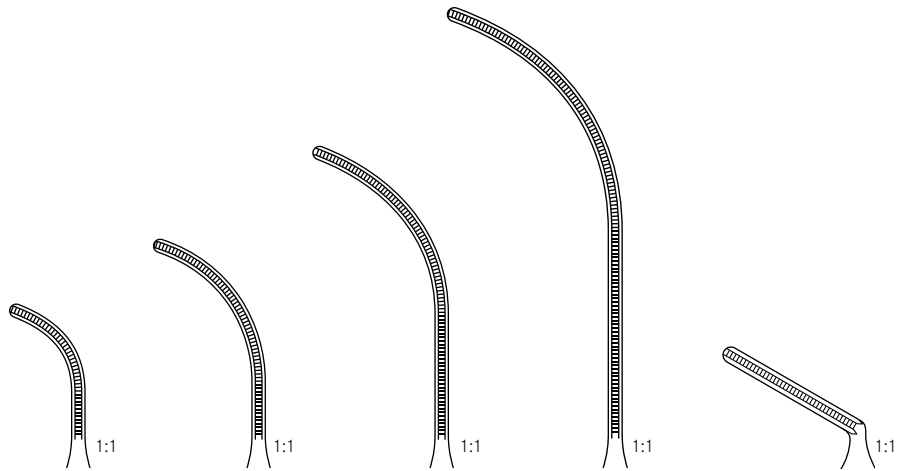

70 mm - 2 3/4"	80 mm - 3 1/4"	100 mm - 4"	115 mm - 4 1/2"	55 mm - 2 1/4"
tk 11951-08	tk 11951-09	tk 11951-10	tk 11951-12	tk 11951-05

abgewinkelt
angled on flat
coudée sur le plat
angulato
angolato

Bulldogklemmen
Bulldog clamps

Clamps Bulldog
Clamps Bulldog
Pinze Bulldog

ATRAUMTK



GLOVER

60 mm - 2 1/2"	70 mm - 2 3/4"	90 mm - 3 1/2"	110 mm - 4 1/4"
tk 11944-06	tk 11944-07	tk 11944-09	tk 11944-11



GLOVER

55 mm - 2 1/4"	65 mm - 2 1/2"	85 mm - 3 1/4"	105 mm - 4 1/4"	50 mm - 2"
tk 11945-06	tk 11945-07	tk 11945-09	tk 11945-11	tk 11945-05

abgewinkelt
angled on flat
coudée sur le plat
angulado
angolato

Bulldogklemmen
Bulldog clamps

Clamps Bulldog
Clamps Bulldog
Pinze Bulldog

ATRAUMTK

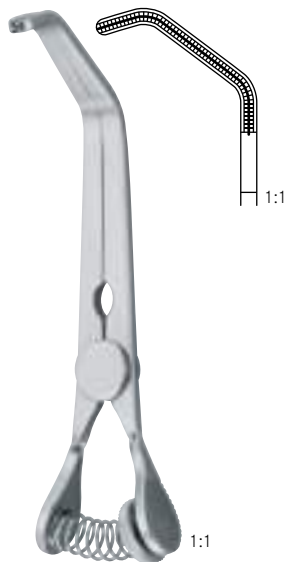

DE BAKEY-SATINSKY

70 mm - 2¾"

tk 11953-07

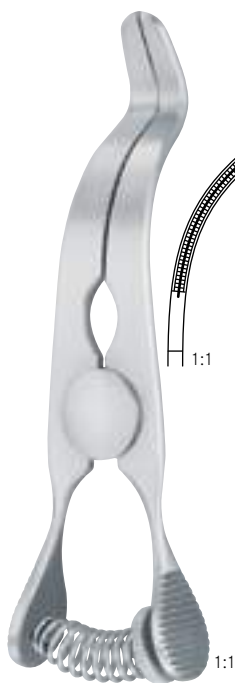

DE BAKEY-CAROTIS

90 mm - 3½"

tk 11953-09

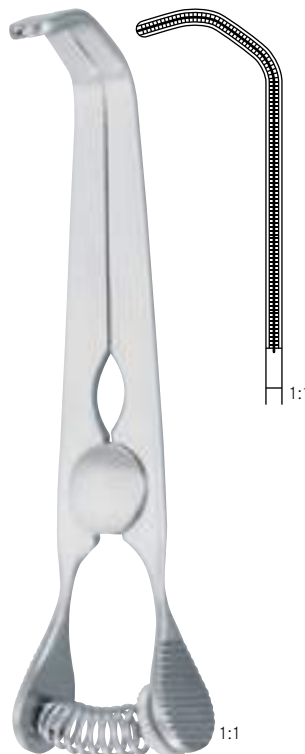

DE BAKEY-SATINSKY

100 mm - 4"

tk 11953-10



SANTULLI

70 mm - 2¾"

tk 11957-07



GREGORY-SOFT

90 mm - 3½"

tk 11959-09

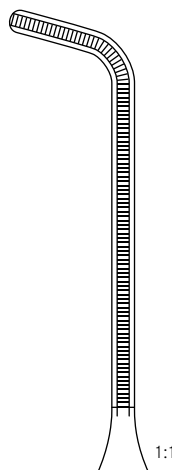

110 mm - 4¼"

tk 11959-11

Atraumatische Pinzetten
Atraumatic tissue forceps

Pinces atraumatiques
Pinzas atraumáticas de disección
Pinze atraumatiche per dissezione

ATRAUMTK

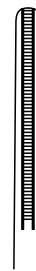
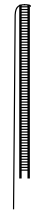
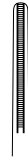
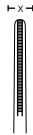

DE BAKEY

	x = 1.5 mm	x = 2.0 mm	x = 2.7 mm	x = 3.5 mm
120 mm - 4¾"	tk 11960-12			
145 mm - 5¾"	tk 11960-14	tk 11964-14		
160 mm - 6¼"	tk 11960-16	tk 11964-16	tk 11966-16	tk 11965-16
200 mm - 8"	tk 11960-20	tk 11964-20	tk 11966-20	tk 11965-20
240 mm - 9½"	tk 11960-24	tk 11964-24	tk 11966-24	tk 11965-24
300 mm - 12"		tk 11964-30	tk 11966-30	tk 11965-30
350 mm - 14"				tk 11965-35

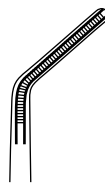
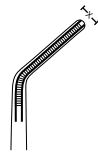

	x = 1.5 mm	x = 2.0 mm
145 mm - 5¾"	tk 11967-14	
160 mm - 6¼"		tk 11967-16
200 mm - 8"		tk 11967-20
240 mm - 9½"		tk 11967-24
300 mm - 12"		tk 11967-30

Atraumatische Pinzetten
Atraumatic tissue forceps

Pinces atraumatiques
Pinzas atraumáticas de disección
Pinze atraumatiche per dissezione

TITAN^{TK}

ATRAUM^{TK}

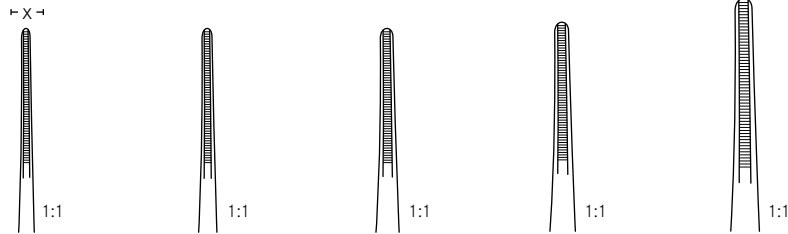

DE BAKEY

	x = 1.2 mm	x = 1.5 mm	x = 1.8 mm	x = 2.0 mm	x = 2.8 mm
160 mm - 6¼"	tk 11970-16	tk 11971-16	tk 11972-16	tk 11975-16	tk 11976-16
200 mm - 8"	tk 11970-20	tk 11971-20	tk 11972-20	tk 11975-20	tk 11976-20
240 mm - 9½"	tk 11970-24	tk 11971-24	tk 11972-24	tk 11975-24	tk 11976-24

Atraumatische Pinzetten
Atraumatic tissue forceps

Pinces atraumatiques
Pinzas atraumáticas de disección
Pinze atraumatiche per dissezione

TITAN **TK**

ATRAUM **TK**

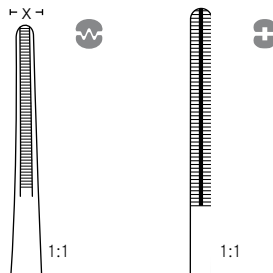

	x = 2.5 mm	x = 3.0 mm
150 mm - 6"	tk 11962-15	tk 11963-15
200 mm - 8"	tk 11962-20	tk 11963-20
240 mm - 9½"	tk 11962-24	tk 11963-24

rostfrei
stainless
inoxydable
inoxidable
inossidabile

	x = 2.5 mm	x = 2.8 mm
150 mm - 6"	tk 11978-15	tk 11979-15
200 mm - 8"	tk 11978-20	tk 11979-20
240 mm - 9½"	tk 11978-24	tk 11979-24

TITAN **TK**

Gefäßklemmen
Vascular forceps

Pinces vasculaires
Pinzas vasculares
Pinze vascolari

ATRAUMTK



DE BAKEY-
MOSQUITO

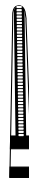

125 mm - 5"	125 mm - 5"
tk 22068-12	tk 22069-12



DE BAKEY-
RANKIN



160 mm - 6¼"	160 mm - 6¼"
tk 22066-16	tk 22067-16

Gefäßklemmen
Vascular forceps

Pinces vasculaires
Pinzas vasculares
Pinze vascolari

ATRAUMTK



DE BAKEY-PEAN

140 mm - 5 1/2"	160 mm - 6 1/4"	180 mm - 7"	200 mm - 8"
tk 22010-14	tk 22010-16	tk 22010-18	tk 22010-20

DE BAKEY-PEAN

140 mm - 5 1/2"	160 mm - 6 1/4"	180 mm - 7"	200 mm - 8"
tk 22011-14	tk 22011-16	tk 22011-18	tk 22011-20



Bulldogklemmen mit Ringgriff
Ring handle Bulldog clamps

Clamps Bulldog, manches à anneaux
Clamps Bulldog, mangos con anillos
 Pinze Bulldog con manici ad anelli

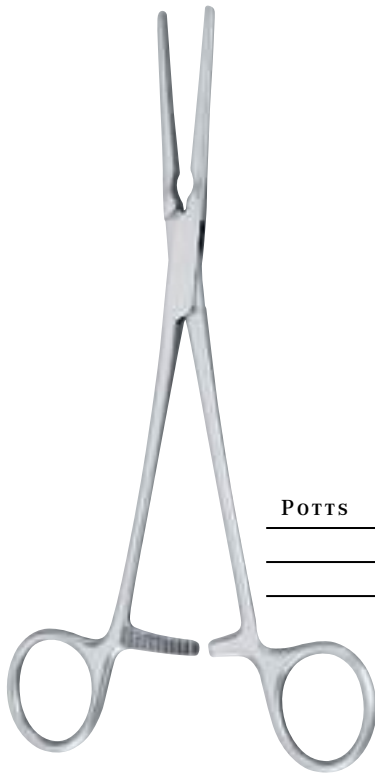

POTTS

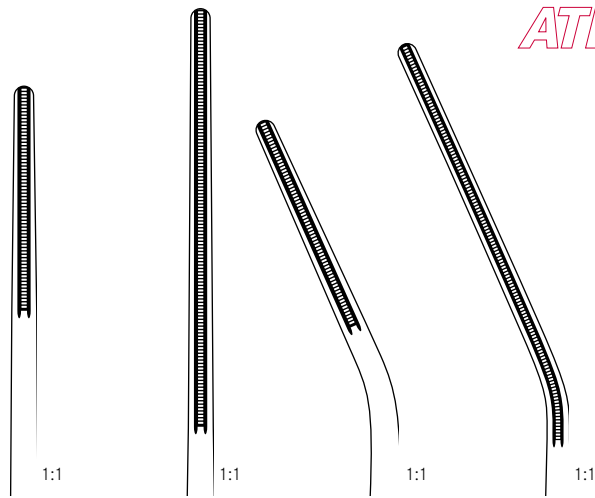

200 mm - 8"	220 mm - 8¾"	200 mm - 8"	220 mm - 8¾"
tk 22070-21	tk 22070-22	tk 22075-21	tk 22075-22

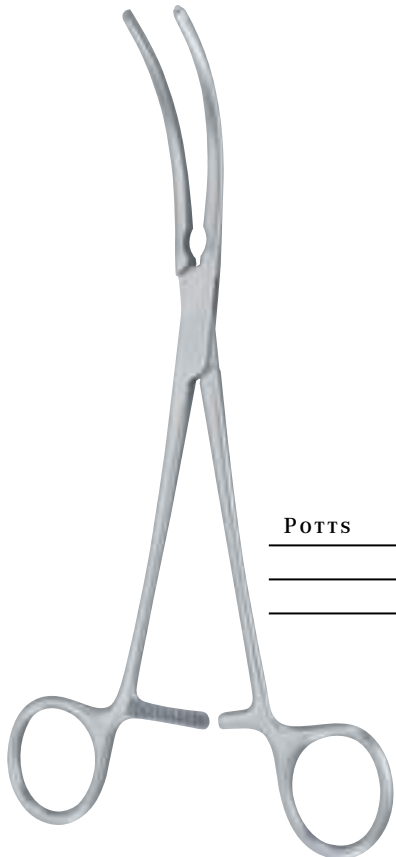

POTTS

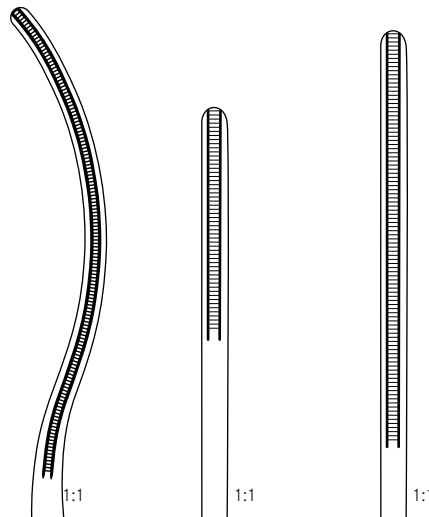

220 mm - 8¾"	210 mm - 8¼"	220 mm - 8¾"
tk 22081-22	tk 22083-21	tk 22083-22

Gefäßklemmen
Vascular forceps

Pinces vasculaires
Pinzas vasculares
Pinze vascolari

ATRAUMTK



DE BAKEY

190 mm - 7½"	230 mm - 9"	160 mm - 6¼"
tk 22048-20	tk 22048-24	tk 22049-16

Gefäßklemmen
Vascular forceps

Pinces vasculaires
Pinzas vasculares
Pinze vascolari

ATRAUMTK

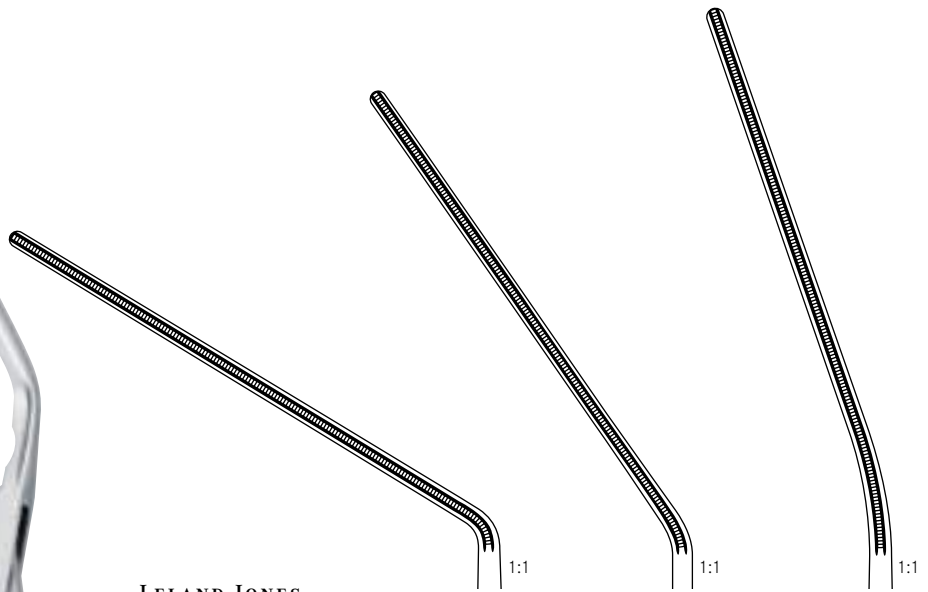
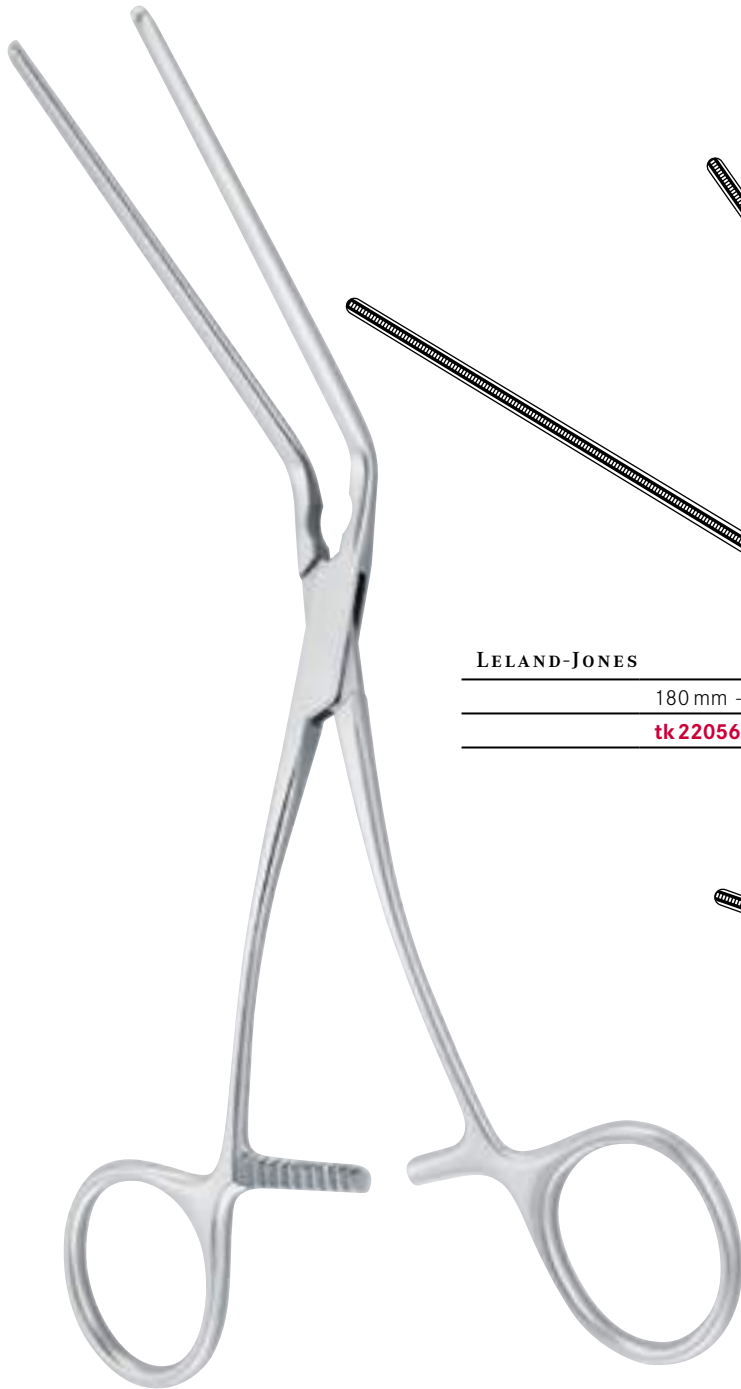

LELAND-JONES

180 mm - 7"	190 mm - 7½"	200 mm - 8"
tk 22056-04	tk 22056-02	tk 22056-03

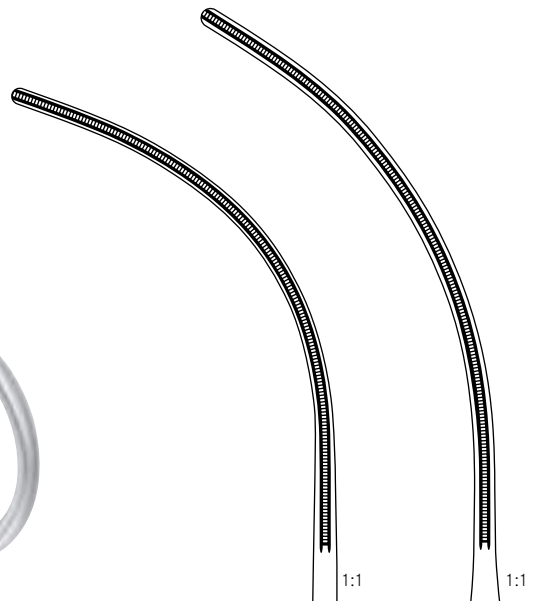

190 mm - 7½"	200 mm - 8"
tk 22049-19	tk 22049-20

Gefäßklemmen
Vascular forceps

Pinces vasculaires
Pinzas vasculares
Pinze vascolari

ATRAUMTK



**BAINBRIDGE,
LIGHT**

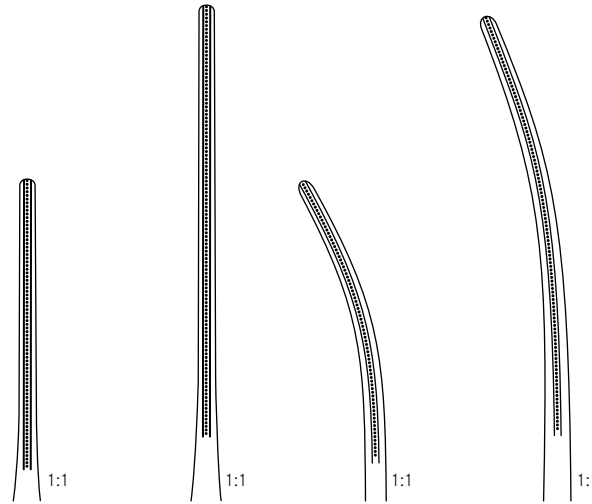

150 mm – 6"	180 mm – 7"	150 mm – 6"	180 mm – 7"
tk 22045-15	tk 22045-18	tk 22046-15	tk 22046-18

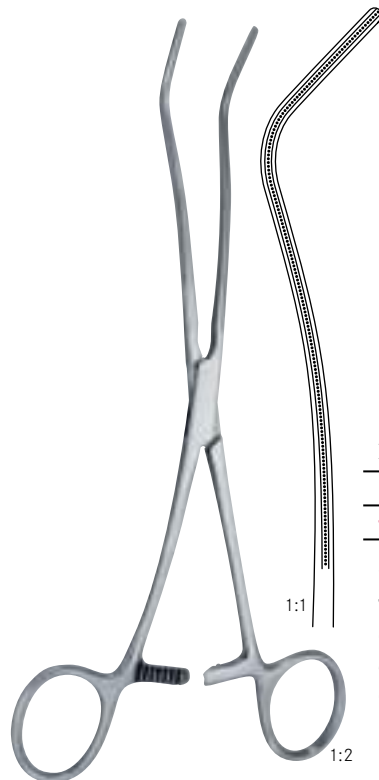

DE BAKEY

200 mm – 8"

tk 22047-20

**S-förmig gebogen
S-curved**

courbe en S
curva en S
curva a forma S

Gefäßklemmen
Vascular forceps

Pinces vasculaires
Pinzas vasculares
Pinze vascolari

ATRAUMTK

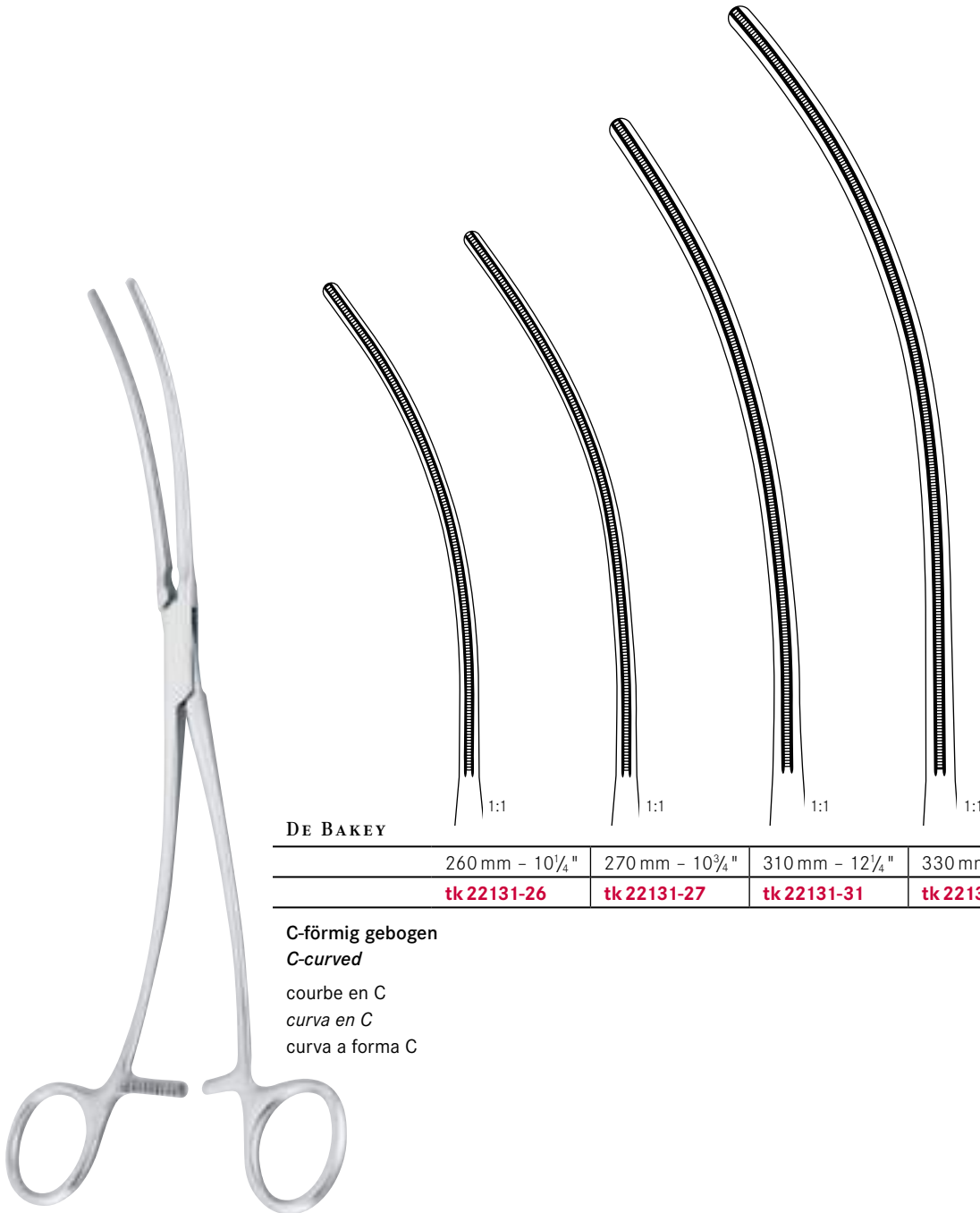

DE BAKEY

260 mm - 10 ¹ / ₄ "	270 mm - 10 ³ / ₄ "	310 mm - 12 ¹ / ₄ "	330 mm - 13 ³ / ₄ "
tk 22131-26	tk 22131-27	tk 22131-31	tk 22131-33

C-förmig gebogen
C-curved
courbe en C
curva en C
curva a forma C

Gefäßklemmen
Vascular forceps

Pinces vasculaires
Pinzas vasculares
Pinze vascolari

ATRAUMTK

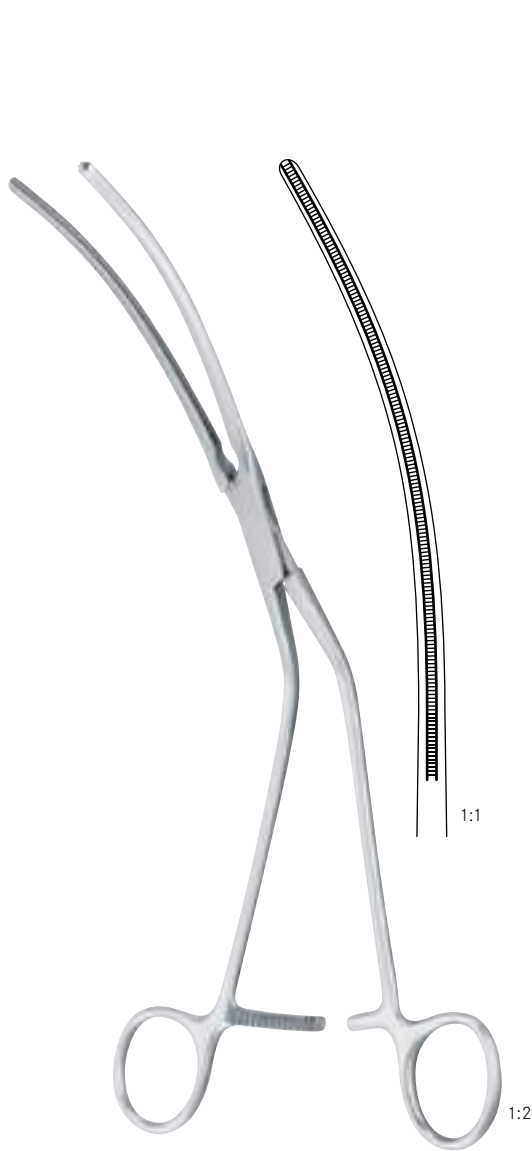

DE BAKEY

280 mm – 11"

tk 22136-28



S-förmig gebogen

S-curved

courbe en S

curva en S

curva a forma S

Gefäßklemmen
Vascular forceps

Pinces vasculaires
Pinzas vasculares
Pinze vascolari

ATRAUMTK



WEBER

260 mm - 10 3/4"

tk 22140-26

links gebogen
curved left
courbe à gauche
curva a la izquierda
curvata a sinistra

260 mm - 10 3/4"

tk 22141-26

rechts gebogen
curved right
courbe à droite
curva a la derecha
curvata a destra

Gefäßklemmen
Vascular forceps

Pinces vasculaires
Pinzas vasculares
Pinze vascolari

ATRAUMTK

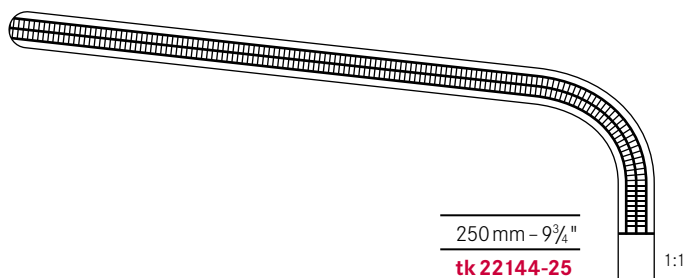
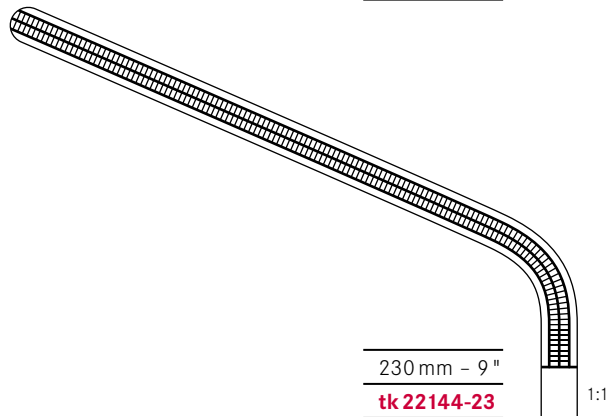
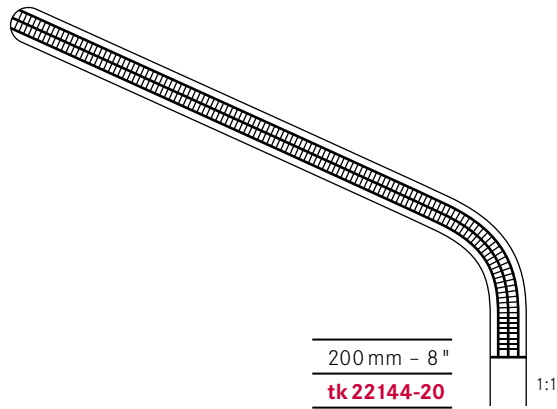
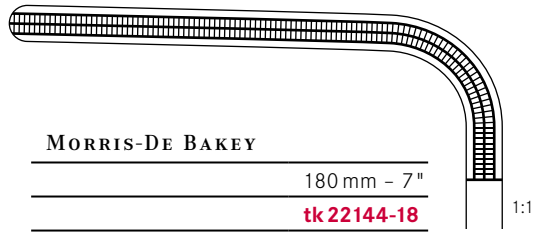

Gefäßklemmen
Vascular forceps

Pinces vasculaires
Pinzas vasculares
Pinze vascolari

ATRAUMTK

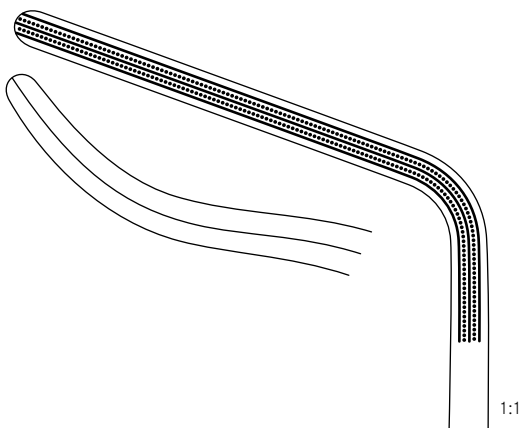

DE BAKEY

270 mm - 10³/₄"

tk 22116-27

Gefäßklemmen | Pincés vasculaires
Vascular forceps | *Pinzas vasculares*
 Pinze vascolari

ATRAUMTK

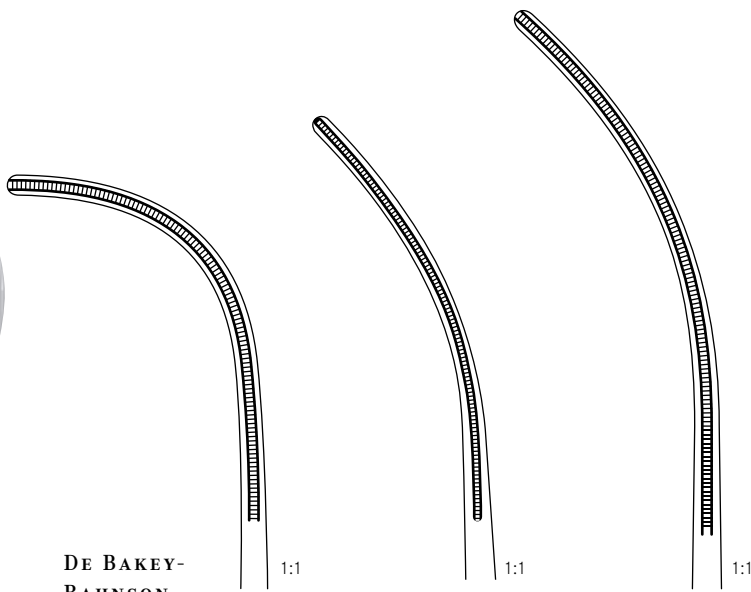

DE BAKEY-
BAHNSON

240 mm - 9½"	250 mm - 9¾"	260 mm - 10¼"
tk 22145-23	tk 22145-24	tk 22145-25

Gefäßklemmen
Vascular forceps

Pinces vasculaires
Pinzas vasculares
Pinze vascolari

ATRAUMTK

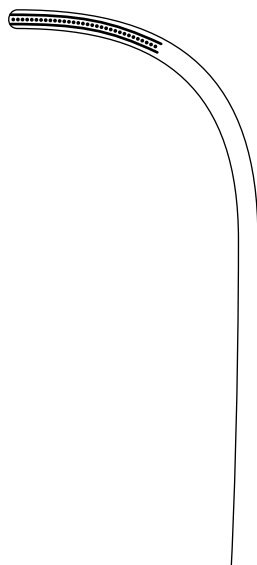

1:1

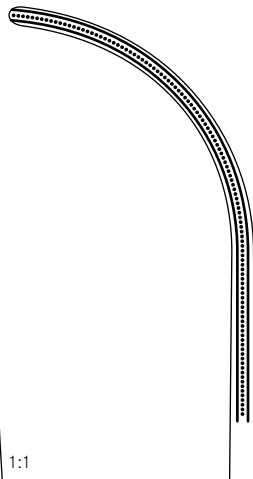

1:1

DE BAKEY-SEMB

240 mm - 9 1/2"

tk 22117-24

tk 22118-24

1:2

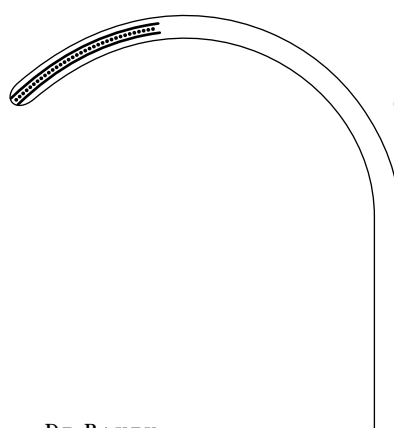

1:1

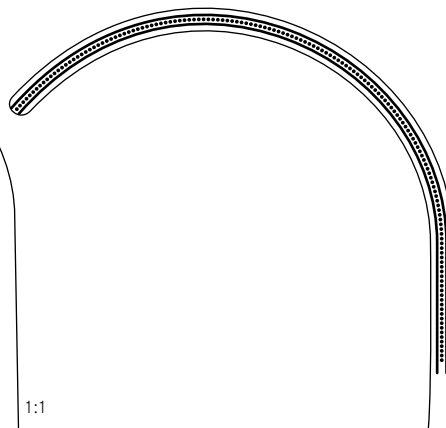

1:1

DE BAKEY

250 mm - 10"

260 mm - 10 1/4"

tk 22120-25

tk 22120-26

Gefäßklemmen
Vascular forceps

Pinces vasculaires
Pinzas vasculares
Pinze vascolari

ATRAUMTK

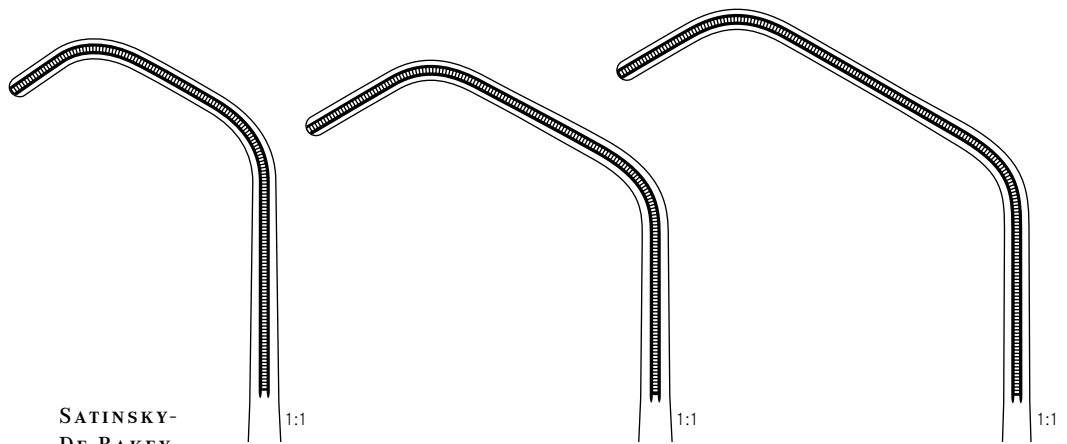

SATINSKY-
DE BAKEY

205 mm - 8"	240 mm - 9 ³ / ₄ "	250 mm - 10"
tk 22125-20	tk 22125-24	tk 22125-25

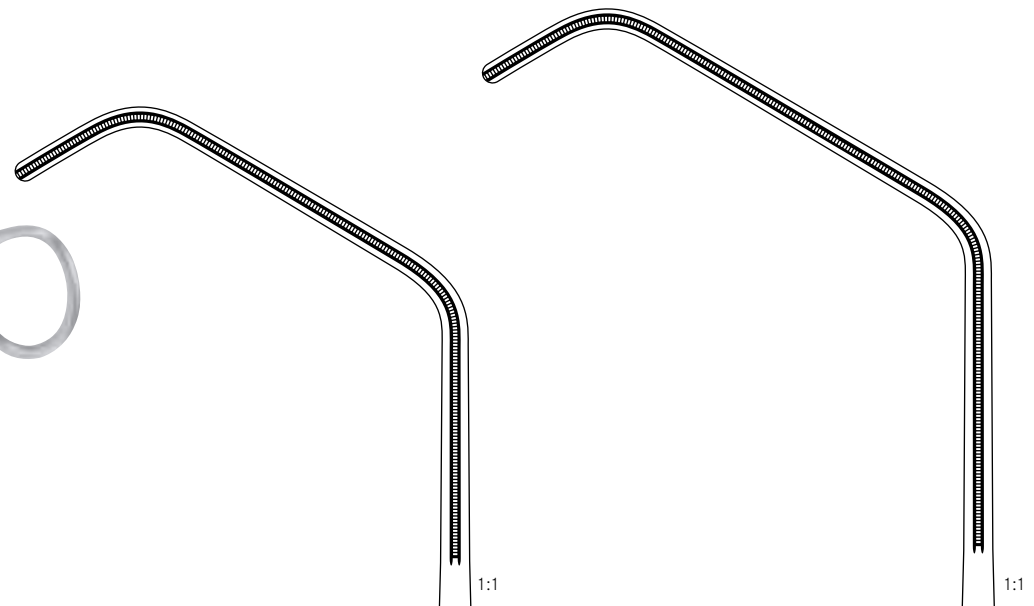

265 mm - 10 ¹ / ₂ "	275 mm - 10 ³ / ₄ "
tk 22125-26	tk 22125-27

Gefäßklemmen
Vascular forceps

Pinces vasculaires
Pinzas vasculares
Pinze vascolari

ATRAUMTK

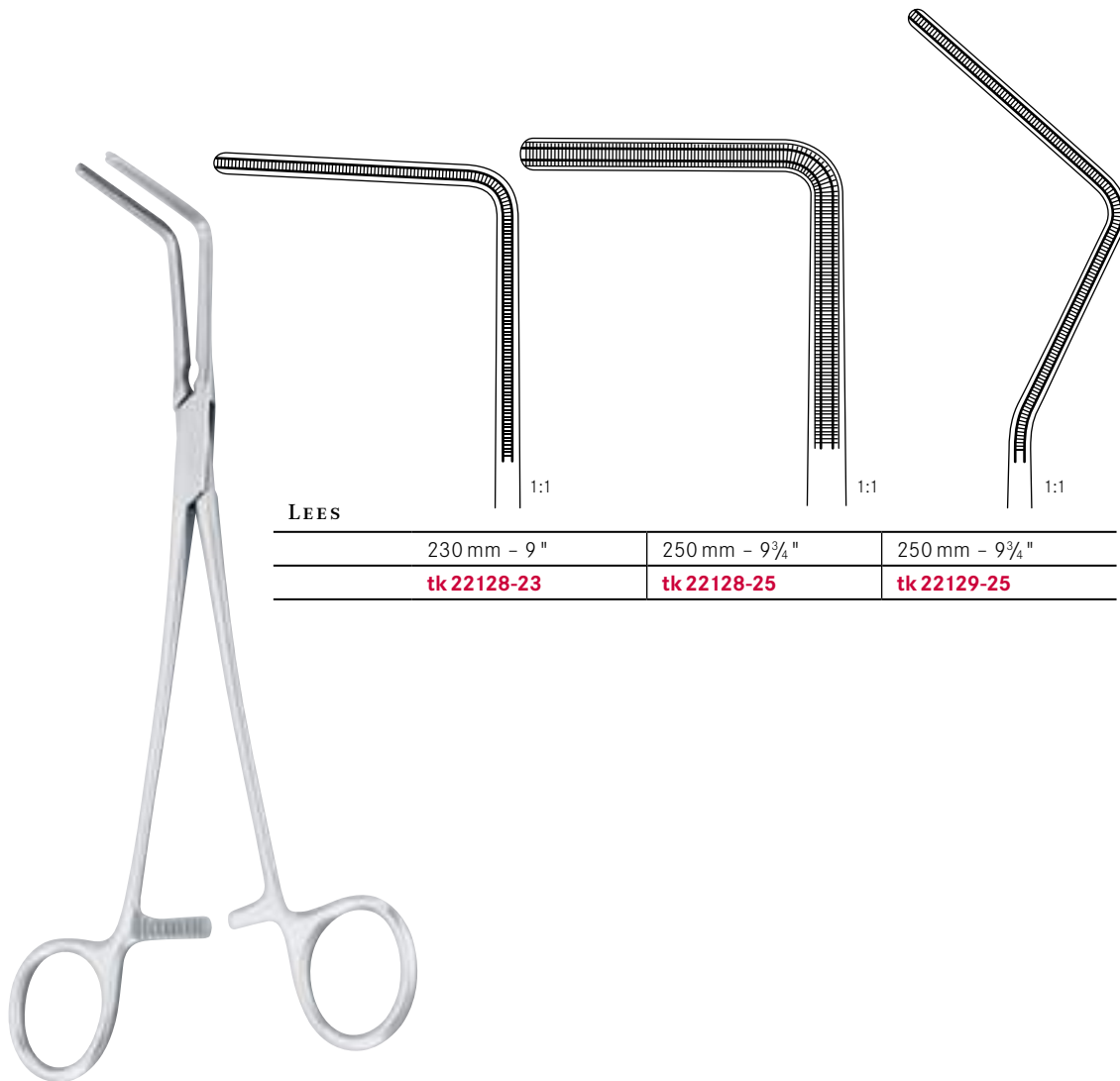

LEES	230 mm - 9"	250 mm - 9¾"	250 mm - 9¾"
	tk 22128-23	tk 22128-25	tk 22129-25

Gefäßklemmen
Vascular forceps

Pinces vasculaires
Pinzas vasculares
Pinze vascolari

ATRAUMTK

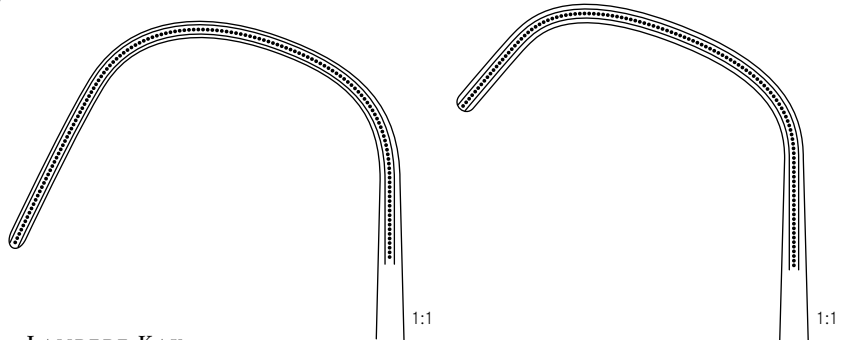

LAMBERT-KAY

200 mm - 8"

tk22138-21

tk22139-21

Gefäßklemmen
Vascular forceps

Pinces vasculaires
Pinzas vasculares
Pinze vascolari



DE BAKEY

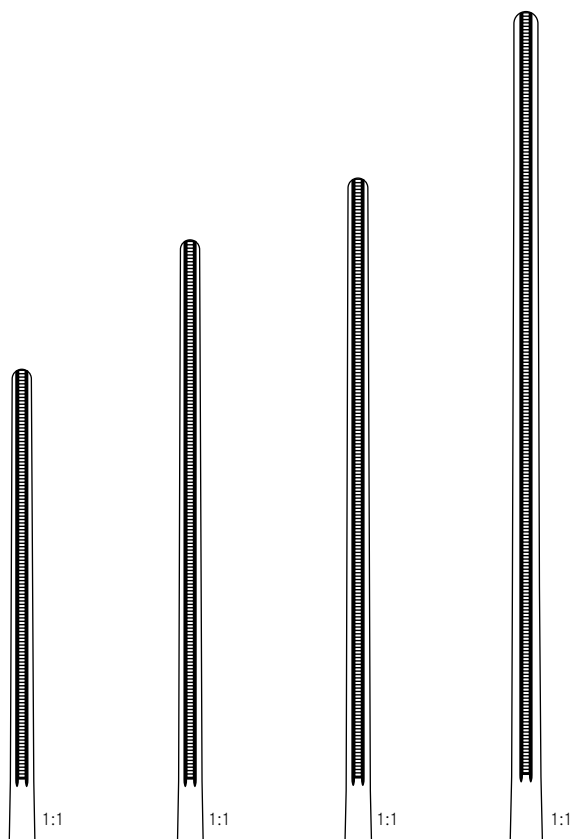

215 mm - 8½"	230 mm - 9"	270 mm - 10¾"	315 mm - 12½"
tk 22133-21	tk 22133-23	tk 22133-27	tk 22133-31

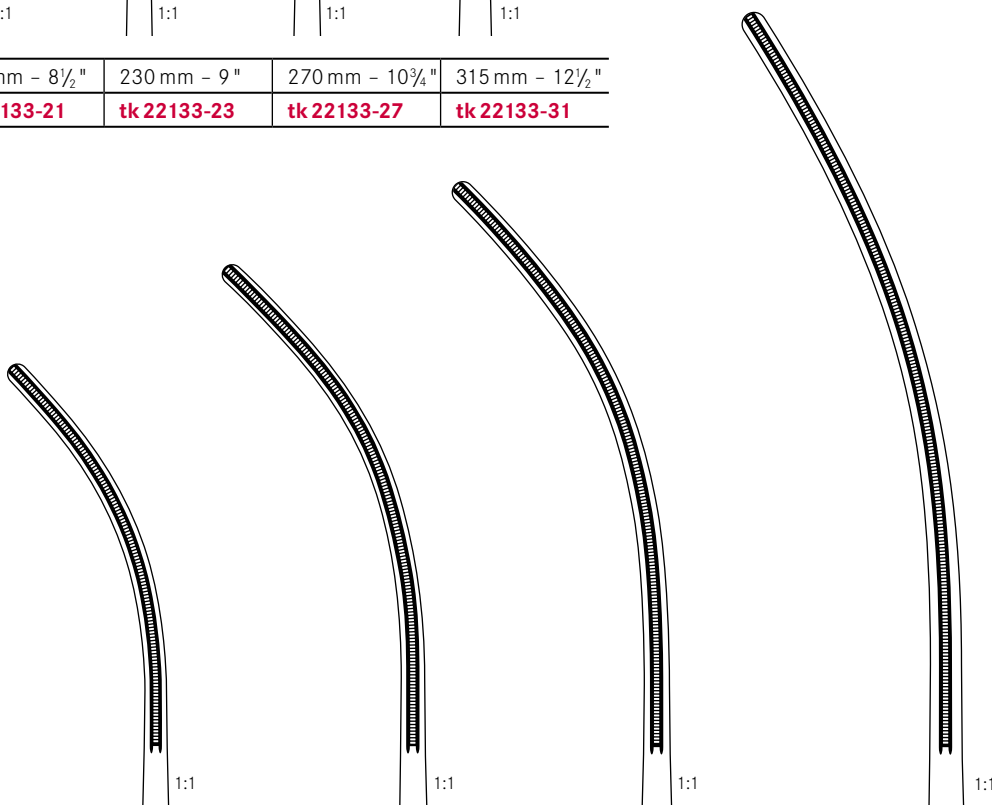

215 mm - 8½"	230 mm - 9"	270 mm - 10¾"	315 mm - 12½"
tk 22135-21	tk 22135-23	tk 22135-27	tk 22135-31

Gefäßklemmen
Vascular forceps

Pinces vasculaires
Pinzas vasculares
Pinze vascolari

ATRAUMTK

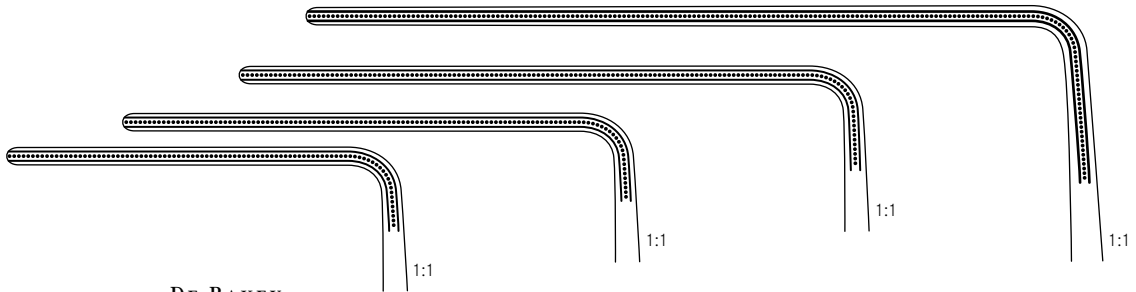

DE BAKEY

180 mm - 7"	190 mm - 7½"	230 mm - 9"	270 mm - 10¾"
tk 22110-18	tk 22110-19	tk 22110-23	tk 22110-27

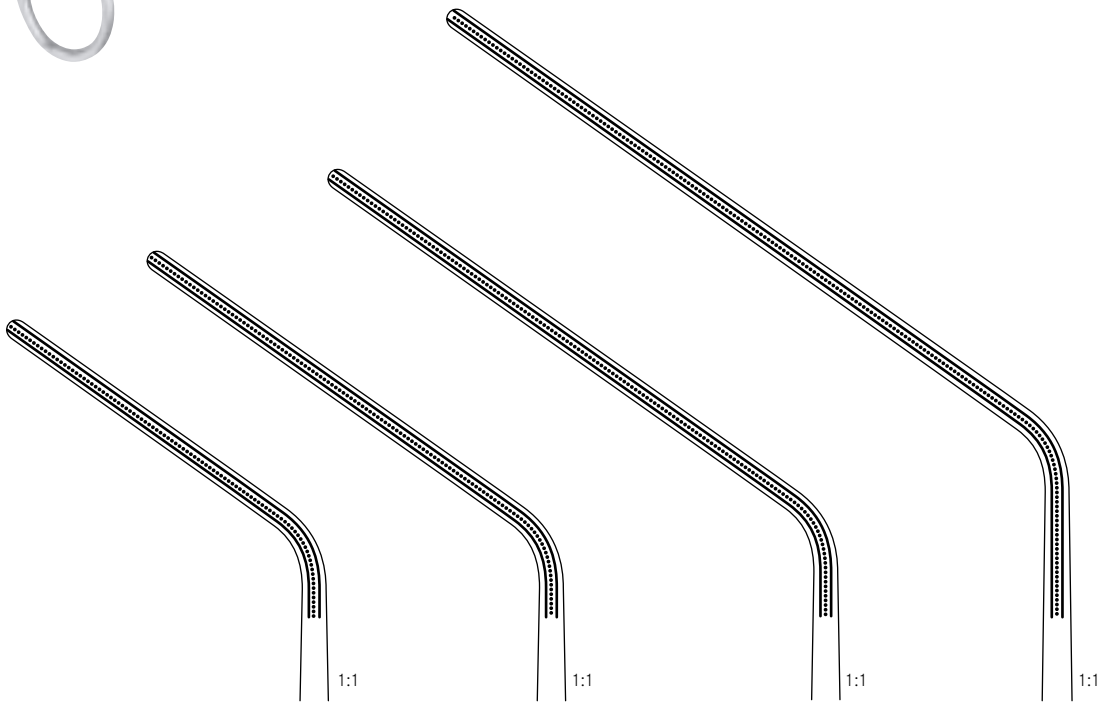

200 mm - 8"	210 mm - 8¼"	250 mm - 9¾"	300 mm - 12"
tk 22112-20	tk 22112-21	tk 22112-25	tk 22112-29

Gefäßklemmen
Vascular forceps

Pinces vasculaires
Pinzas vasculares
Pinze vascolari

ATRAUMTK

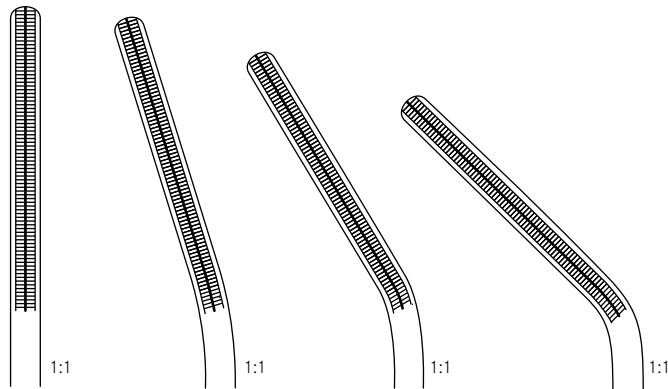

DARDIK

	0°	15°	30°	45°
170 mm - 6 3/4"	tk 22545-00	tk 22545-15	tk 22545-30	tk 22545-45

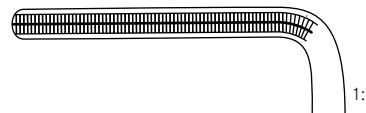

	90°
160 mm - 6 1/4"	tk 22545-90

Gefäßklemmen
Vascular forceps

Pinces vasculaires
Pinzas vasculares
Pinze vascolari

ATRAUMTK

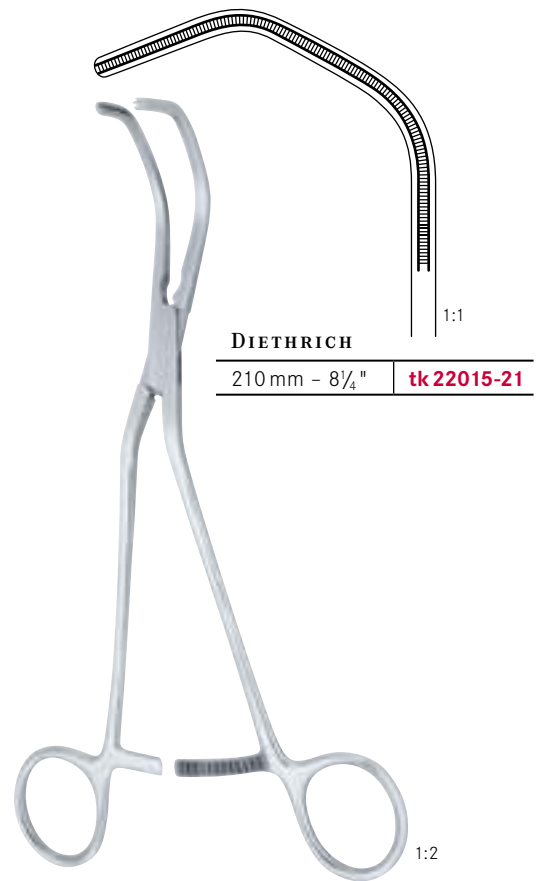
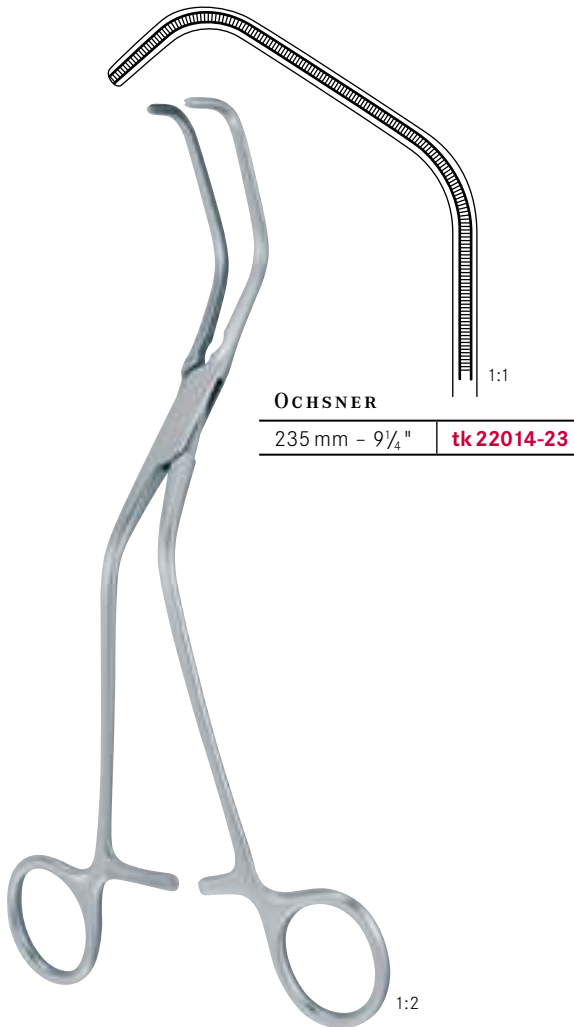

Gefäßklemmen
Vascular forceps

Pinces vasculaires
Pinzas vasculares
Pinze vascolari

ATRAUMTK

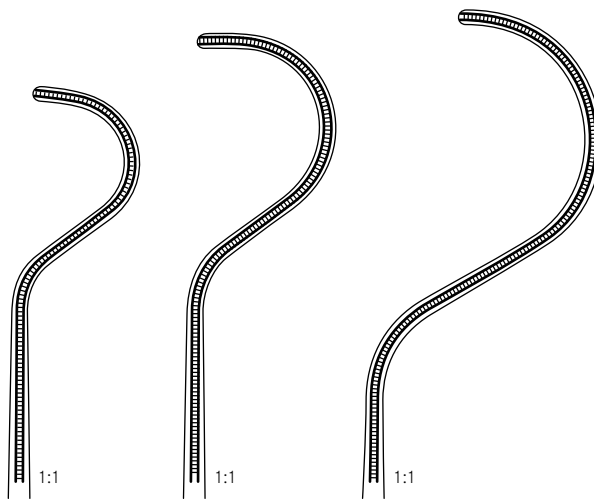
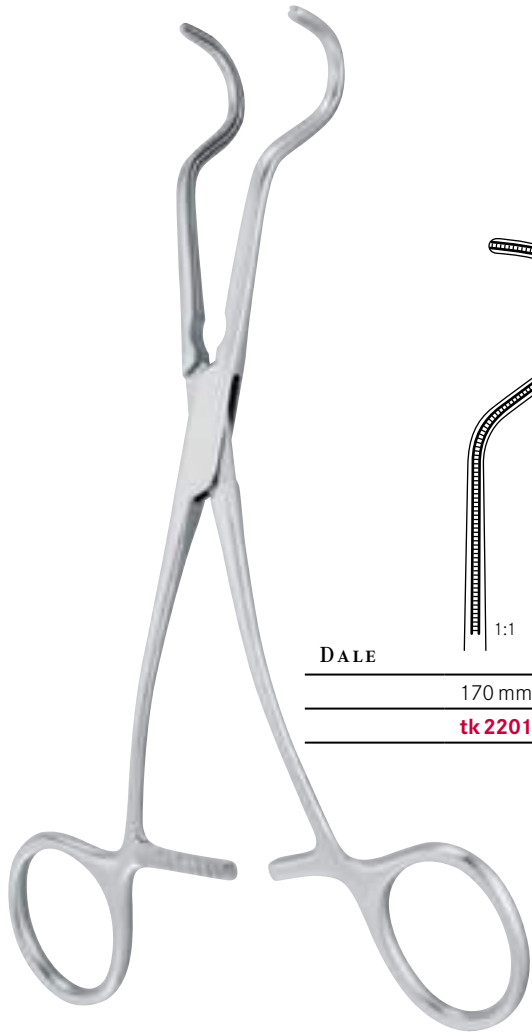

DALE

170 mm - 6 3/4"	175 mm - 7"	185 mm - 7 1/4"
tk 22017-17	tk 22017-18	tk 22017-19

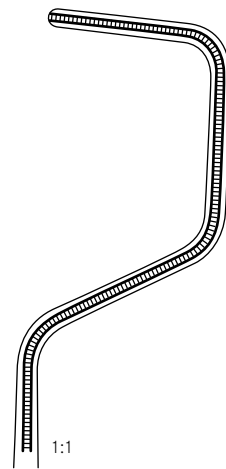

185 mm - 7 1/4"
tk 22016-18

Gefäßklemmen
Vascular forceps

Pinces vasculaires
Pinzas vasculares
Pinze vascolari

ATRAUMTK

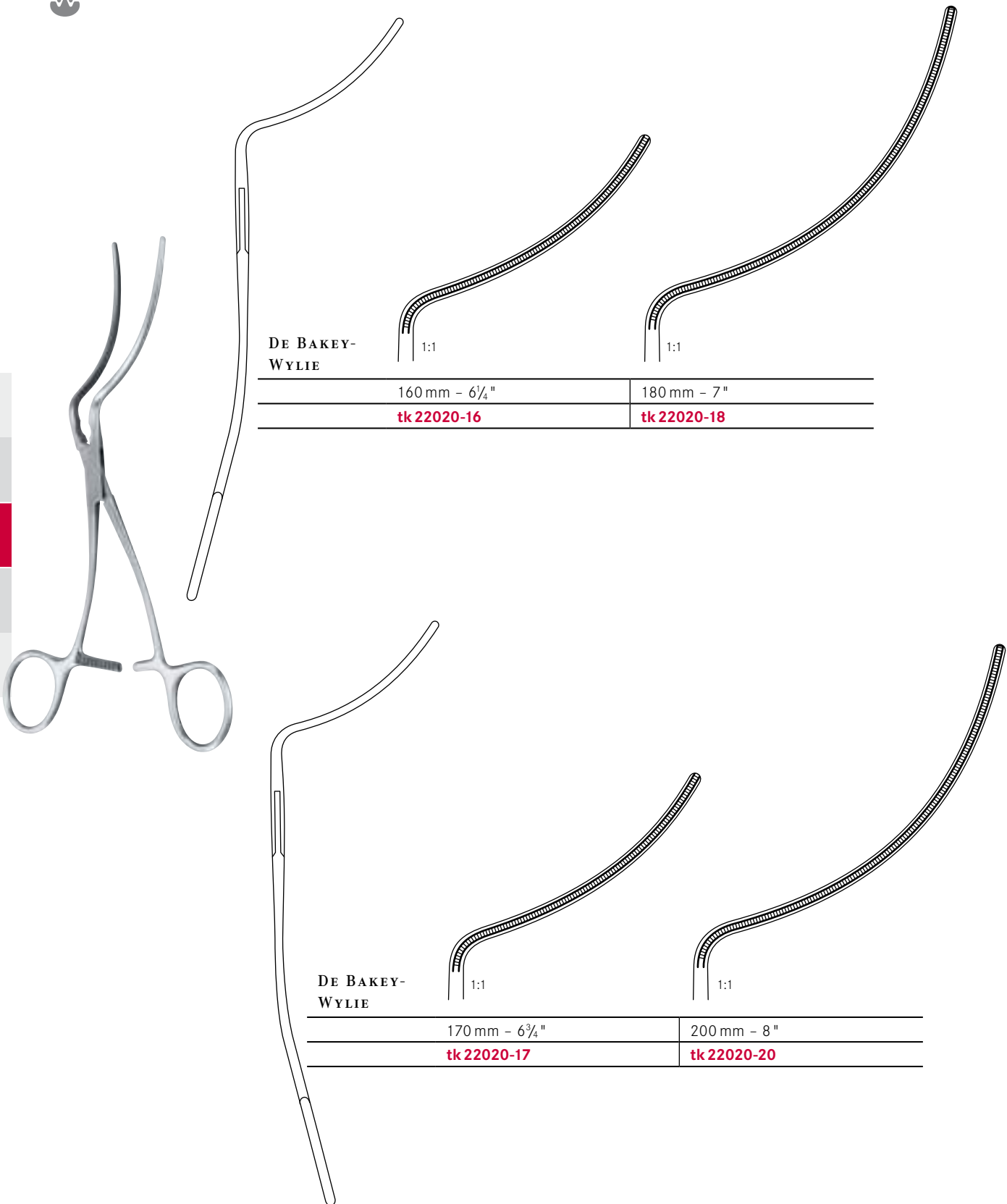

DE BAKEY-
WYLIE

160 mm - 6 $\frac{3}{4}$ "

tk 22020-16

1:1

180 mm - 7"

tk 22020-18

DE BAKEY-
WYLIE

170 mm - 6 $\frac{3}{4}$ "

tk 22020-17

1:1

200 mm - 8"

tk 22020-20

Gefäßklemmen
Vascular forceps

Pinces vasculaires
Pinzas vasculares
Pinze vascolari

ATRAUMTK

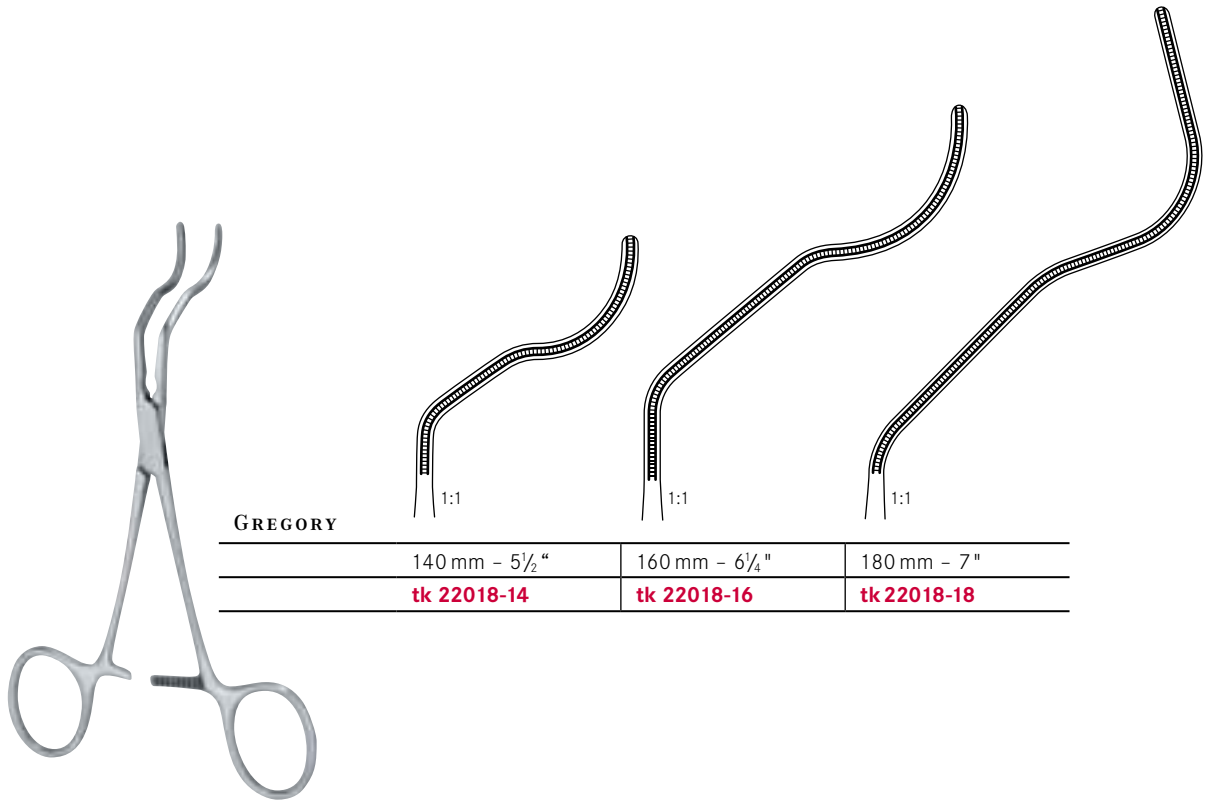

GREGORY

140 mm - 5½"	160 mm - 6¼"	180 mm - 7"
tk 22018-14	tk 22018-16	tk 22018-18

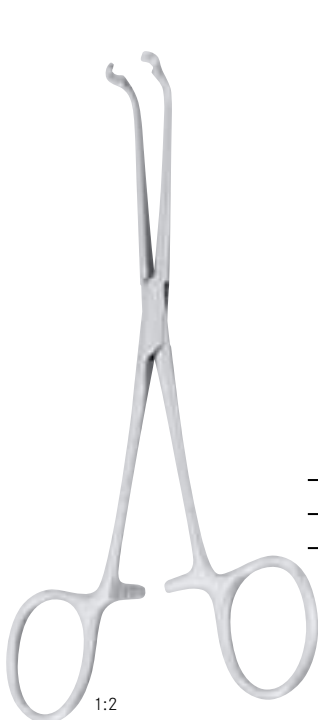

1:2

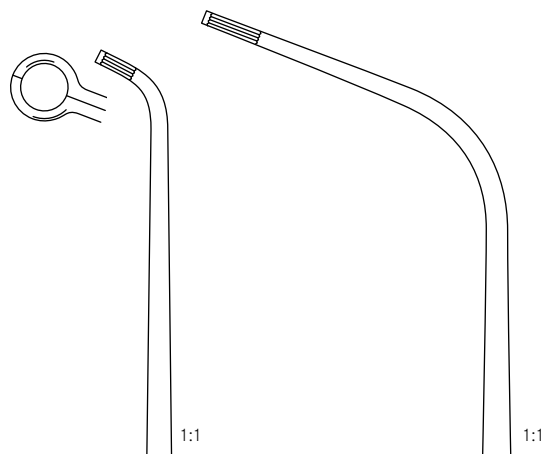

JAVID

160 mm - 6¼"	190 mm - 7½"
tk 22019-16	tk 22019-19

Gefäßklemmen
Vascular forceps

Pinces vasculaires
Pinzas vasculares
Pinze vascolari

ATRAUMTK



DE BAKEY

120 mm - 4 ³ / ₄ "	110 mm - 4 ¹ / ₄ "	100 mm - 4"
tk 22028-12	tk 22029-11	tk 22032-13

gerade
straight
droite
recta
retta

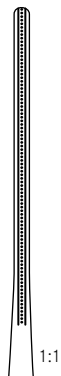
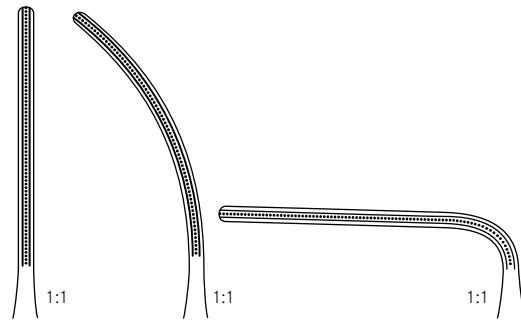

DE BAKEY

170 mm - 6 ³ / ₄ "
tk 22037-01

gerade
straight
droite
recta
retta

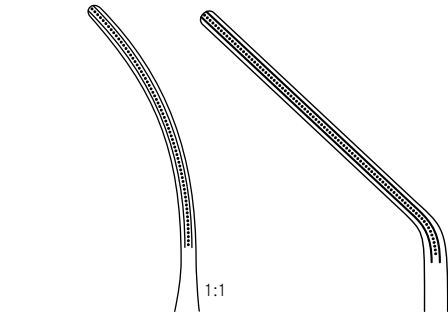

DE BAKEY

120 mm - 4 ³ / ₄ "	130 mm - 5"
tk 22035-12	tk 22041-13

abgewinkelt
angled on flat

coudée sur le plat
anuladoo
angolata

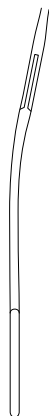

DE BAKEY

170 mm - 6 ³ / ₄ "	160 mm - 6 ¹ / ₄ "	150 mm - 6"	140 mm - 5 ¹ / ₂ "
tk 22043-17	tk 22039-16	tk 22041-15	tk 22042-15

kniegebogen
angled on flat

coudée sur le plat
acodada
angolata

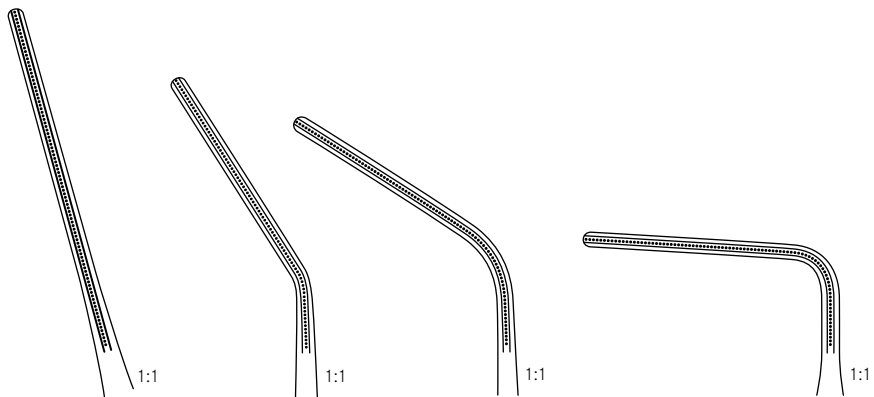

Gefäßklemmen
Vascular forceps

Pinces vasculaires
Pinzas vasculares
Pinze vascolari

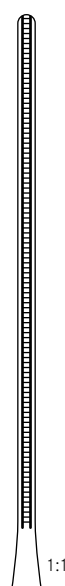
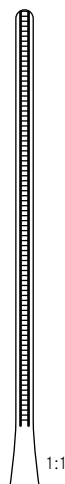
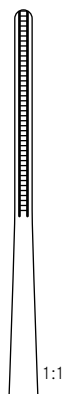

GLOVER

205 mm - 8"	220 mm - 8 ³ / ₄ "	260 mm - 10 ¹ / ₄ "
tk 22060-20	tk 22060-22	tk 22060-26

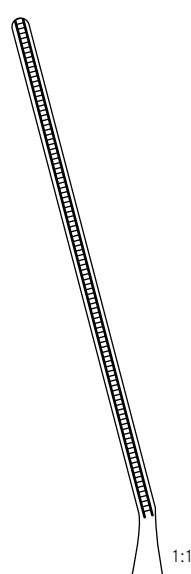
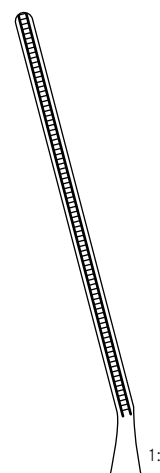
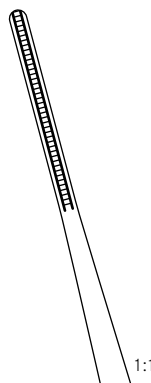

205 mm - 8"	220 mm - 8 ³ / ₄ "	260 mm - 10 ¹ / ₄ "
tk 22061-20	tk 22061-22	tk 22061-26

abgewinkelt
angled on flat
coudé sur le plat
angulado
angolato

abgewinkelt
angled on flat
coudé sur le plat
angulado
angolato

abgewinkelt
angled on flat
coudé sur le plat
angulado
angolato

Gefäßklemmen
Vascular forceps

Pinces vasculaires
Pinzas vasculares
Pinze vascolari

ATRAUMTK

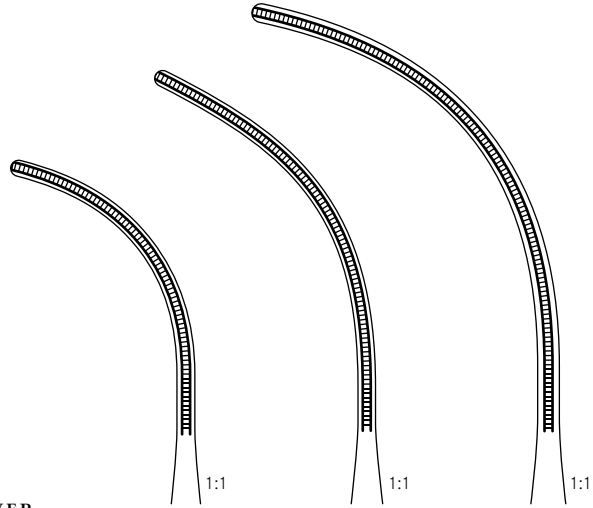

GLOVER

170 mm – 6 ³ / ₄ "	210 mm – 8 ¹ / ₄ "	240 mm – 9 ¹ / ₂ "
tk 22079-17	tk 22079-22	tk 22079-24

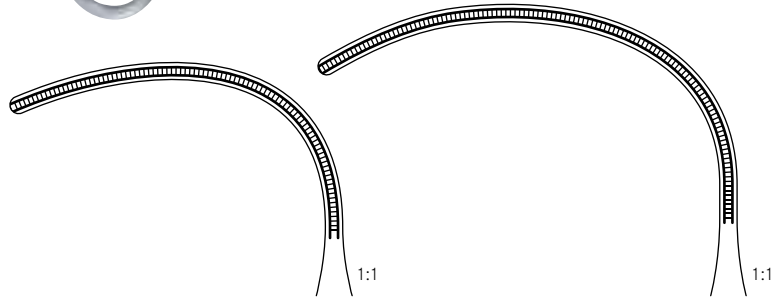

185 mm – 7 ¹ / ₄ "	220 mm – 8 ³ / ₄ "
tk 22078-18	tk 22078-22

Gefäßklemmen
Vascular forceps

Pinces vasculaires
Pinzas vasculares
Pinze vascolari

ATRAUMTK

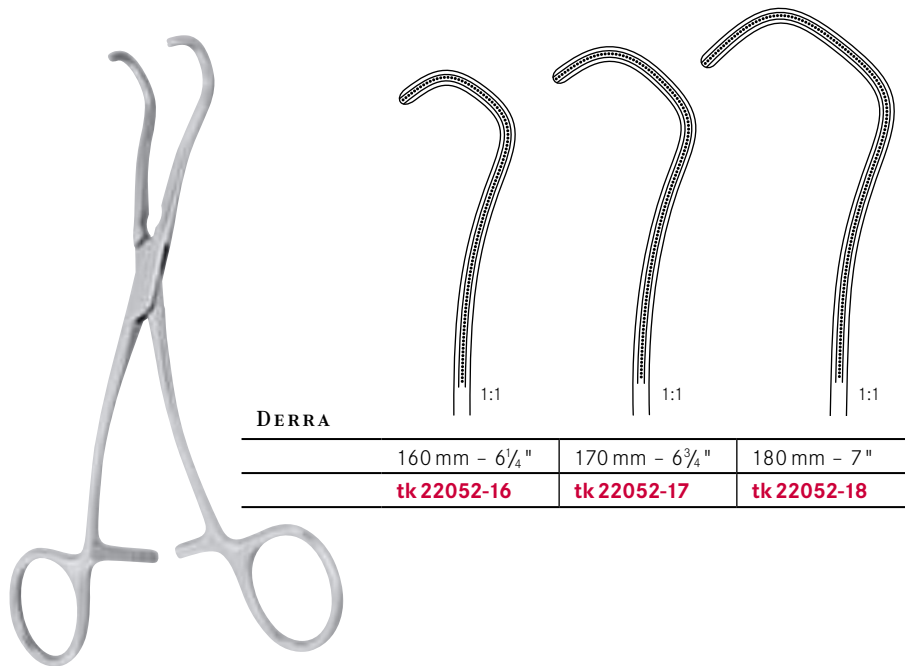

DERRA	160 mm - 6¼"	170 mm - 6¾"	180 mm - 7"
	tk 22052-16	tk 22052-17	tk 22052-18

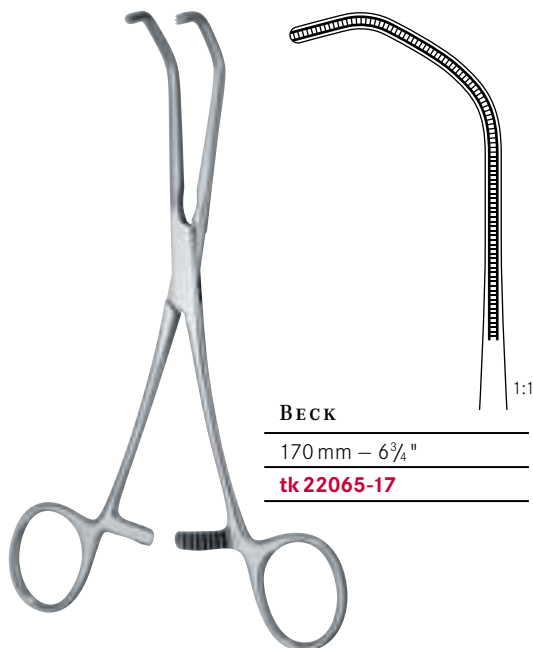

BECK	170 mm - 6¾"
	tk 22065-17

Neonatal- u. Kinderklemmen, extra feine Modelle
Neonatal and children's clamps, extra delicate patterns

Pinces pour nouveaux-nés et enfants, modèles très fins
Pinzas para recién nacidos y niños, modelos muy finos
Pinze per bambini e neonati, molto fine

ATRAUMTK



115mm - 4½"

gebogen
curved
courbe
curva
curve

	Fig. 1	Fig. 2	Fig. 3	Fig. 4
	tk 22541-01	tk 22541-02	tk 22541-03	tk 22541-04

Fig. 5	Fig. 6	Fig. 7	Fig. 8	Fig. 9
tk 22541-05	tk 22541-06	tk 22541-07	tk 22541-08	tk 22541-09

Neonatal- u. Kinderklemmen, extra feine Modelle
Neonatal and children's clamps, extra delicate patterns

Pinces pour nouveaux-nés et enfants, modèles très fins
Pinzas para recién nacidos y niños, modelos muy finos
 Pinze per bambini e neonati, molto fine

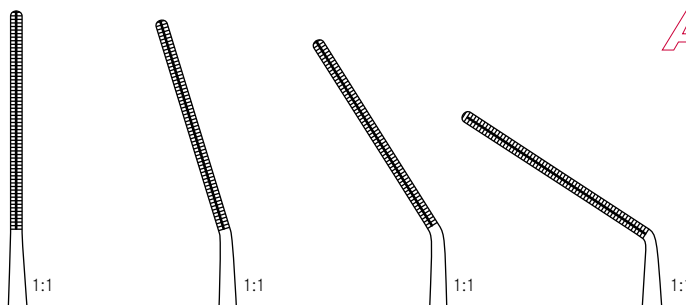

	Fig. 1	Fig. 2	Fig. 3	Fig. 4
115 mm - 4 1/2"	tk 22540-01	tk 22540-02	tk 22540-03	tk 22540-04

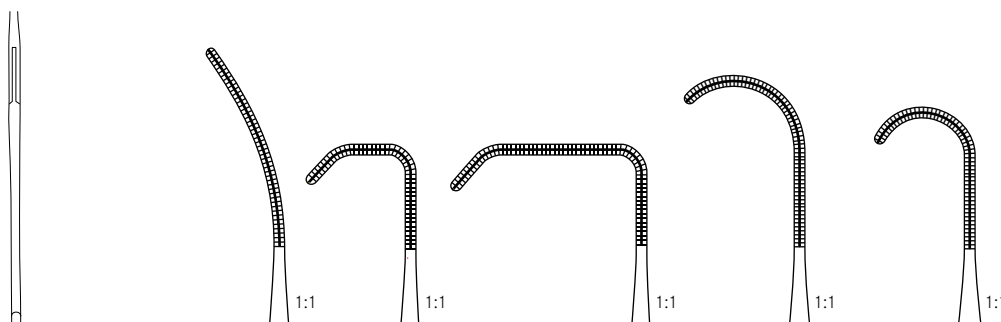

	Fig. 5	Fig. 6	Fig. 7	Fig. 8	Fig. 9
115 mm - 4 1/2"	tk 22540-05	tk 22540-06	tk 22540-07	tk 22540-08	tk 22540-09

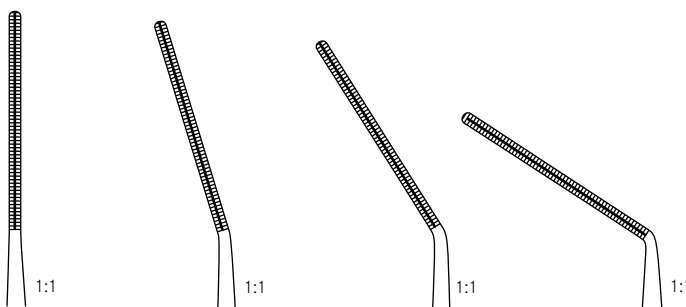
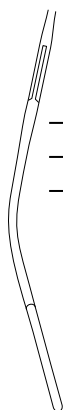

	Fig. 1	Fig. 2	Fig. 3	Fig. 4
115 mm - 4 1/2"	tk 22542-01	tk 22542-02	tk 22542-03	tk 22542-04

abgewinkelt
angled on flat
 coudé sur le plat
 anulado
 angolato

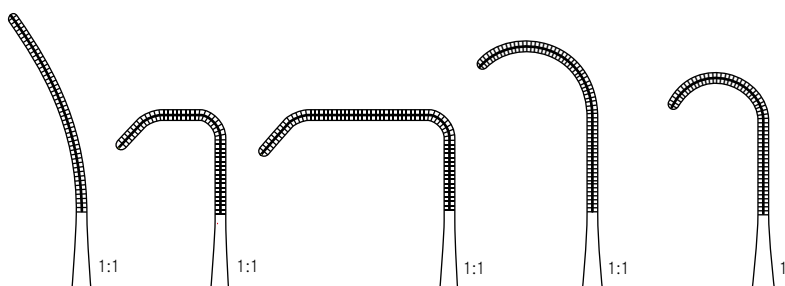
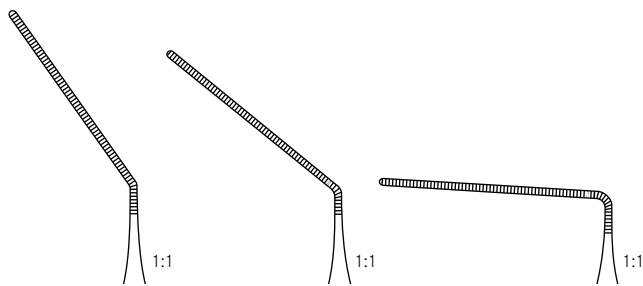
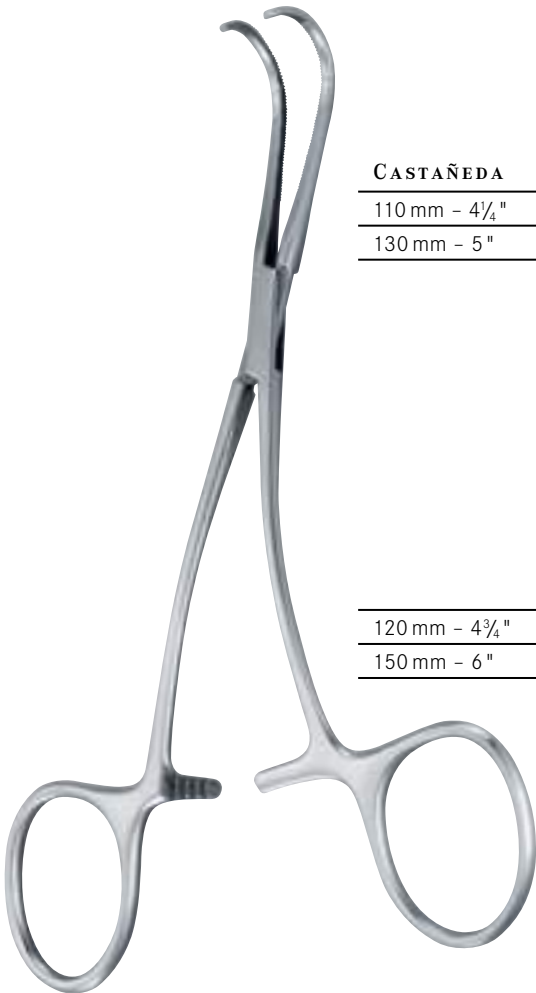

	Fig. 5	Fig. 6	Fig. 7	Fig. 8	Fig. 9
	tk 22542-05	tk 22542-06	tk 22542-07	tk 22542-08	tk 22542-09

Neonatal- u. Kinderklemmen, extra feine Modelle
Neonatal and children's clamps, extra delicate patterns

Pinces pour nouveaux-nés et enfants, modèles très fins
Pinzas para recién nacidos y niños, modelos muy finos
 Pinze per bambini e neonati, molto fine



CASTAÑEDA

110 mm - 4 $\frac{1}{4}$ "			tk 22001-03
130 mm - 5"	tk 22001-01	tk 22001-02	

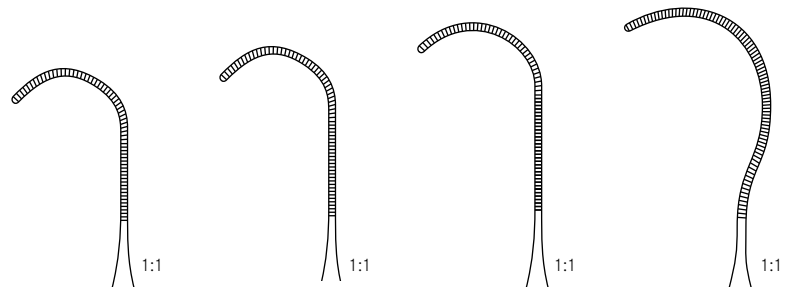

120 mm - 4 $\frac{3}{4}$ "	tk 22001-04	tk 22001-05	tk 22001-06	
150 mm - 6"				tk 22001-07

Gefäßklemmen
Vascular forceps

Pinces vasculaires
Pinzas vasculares
Pinze vascolari

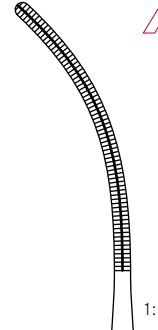
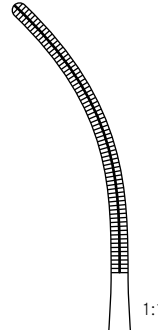
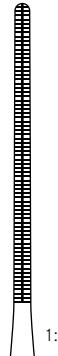

COOLEY

120 mm - 4 3/4"

tk 22562-01

tk 22562-02

tk 22562-03

gerade
straight
droit
recta
retta

gebogen
curved
courbe
curva
curva

S-förmig gebogen
S-curved
courbe en S
curva en S
curva a forma S

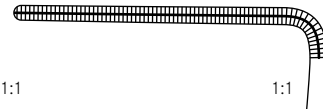
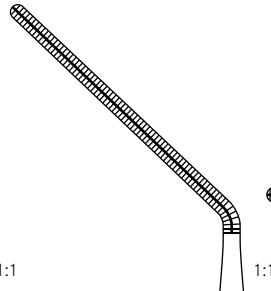
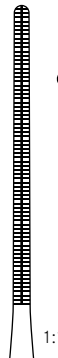

COOLEY

120 mm - 4 3/4"

tk 22562-04

tk 22562-05

tk 22562-06

seitlich gewinkelt
sidewards angled
coudé vers la coté
angulado al lado
angolata lateralmente

abgewinkelt
angled on flat
coudé sur le plat
angulado
angolato

90° abgewinkelt
90° angled on flat
90° coudé sur le plat
90° angulado
90° angolato

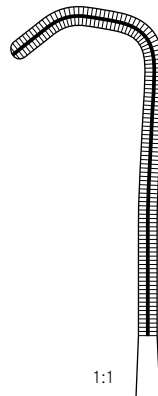

COOLEY

170 mm - 6 3/4"

tk 22509-17

seitlich abgewinkelt
sidewards angled
coudé vers la coté
angulado al lado
angolata lateralmente

Gefäßklemmen
Vascular forceps

Pinces vasculaires
Pinzas vasculares
Pinze vascolari

ATRAUMTK

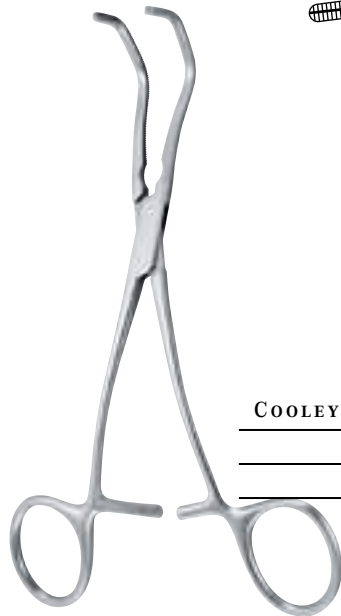

COOLEY

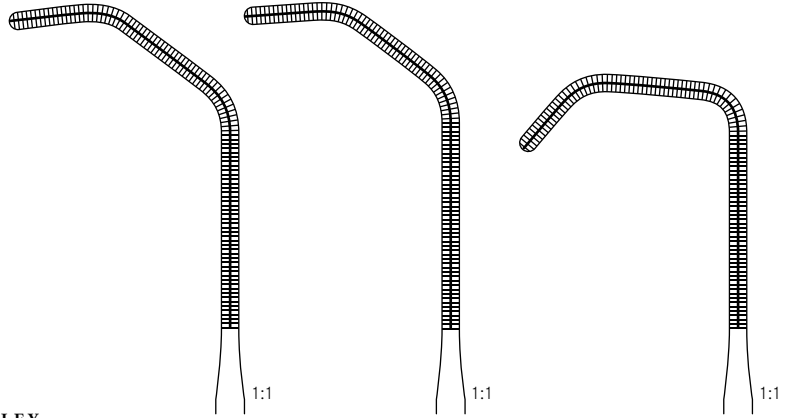

175 mm - 7"	175 mm - 7"	165 mm - 6½"
tk 22565-17	tk 22566-17	tk 22567-01

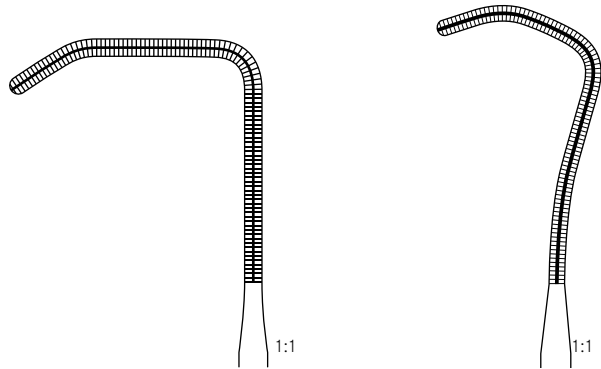

165 mm - 6½"	170 mm - 6¾"
tk 22567-02	tk 22508-16



COOLEY-
DERRA

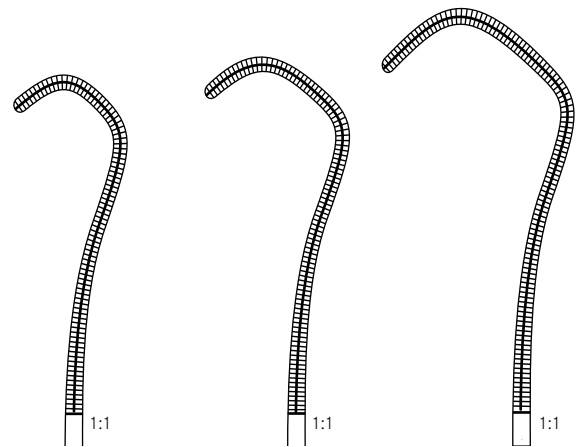

165 mm - 6½"	170 mm - 6¾"	175 mm - 7"
tk 22515-16	tk 22515-17	tk 22515-18

Gefäßklemmen
Vascular forceps

Pinces vasculaires
Pinzas vasculares
Pinze vascolari

ATRAUMTK



COOLEY-
BECK

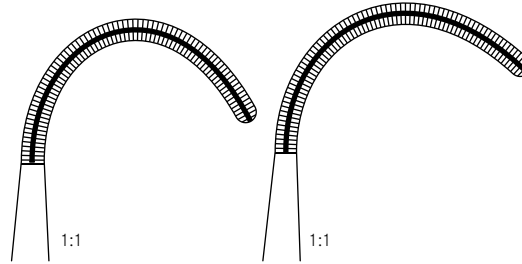

150 mm - 6"	155 mm - 6"
tk 22555-15	tk 22555-16



COOLEY

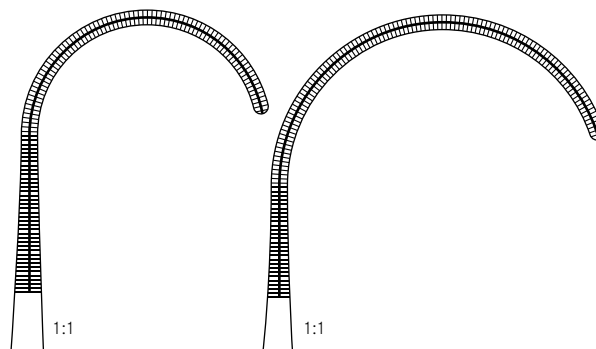

150 mm - 6"	160 mm - 6 1/4"
tk 22522-16	tk 22522-17

Gefäßklemmen
Vascular forceps

Pinces vasculaires
Pinzas vasculares
Pinze vascolari

ATRAUMTK

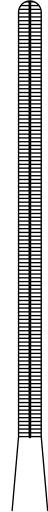
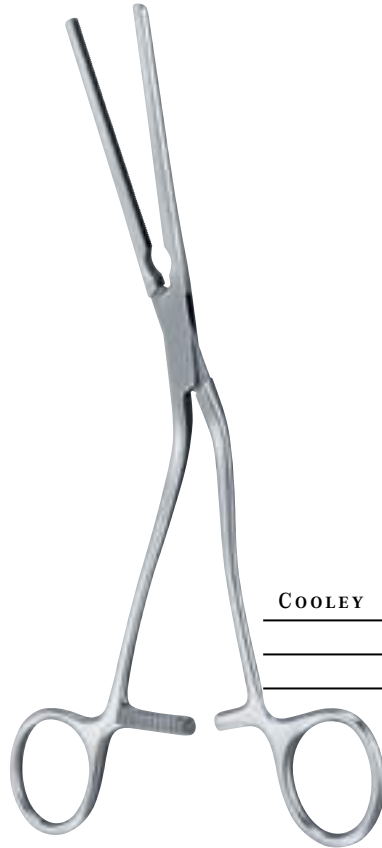

1:1

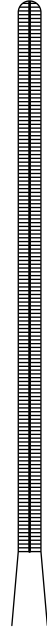

1:1

COOLEY

210 mm – 8 1/4"

tk 22552-21

250 mm – 9 3/4"

tk 22552-25

seitwärts abgewinkelt
sidewards angled on flat
coudé vers la coté
angulado al lado
angolata lateralmente

seitwärts abgewinkelt
sidewards angled on flat
coudé vers la coté
angulado al lado
angolata lateralmente

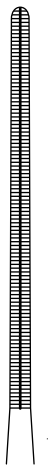

1:1

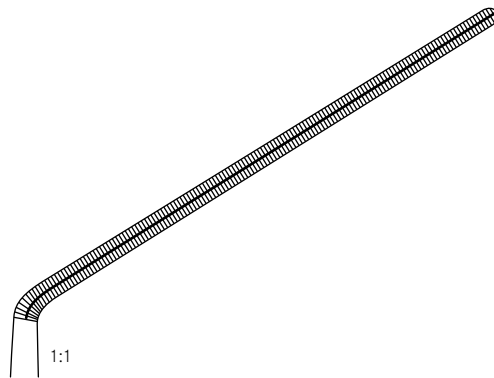

1:1

COOLEY

180 mm – 7"

tk 22560-18

185 mm – 7 1/4"

tk 22561-18

gerade
straight
droite
recta
retta

abgewinkelt
angled on flat
coudé sur le plat
angulado
angolata

Gefäßklemmen
Vascular forceps

Pinces vasculaires
Pinzas vasculares
Pinze vascolari

ATRAUMTK

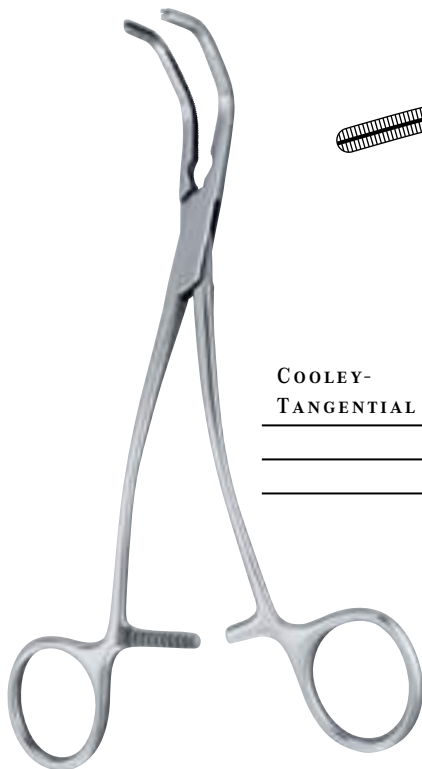

COOLEY-
TANGENTIAL

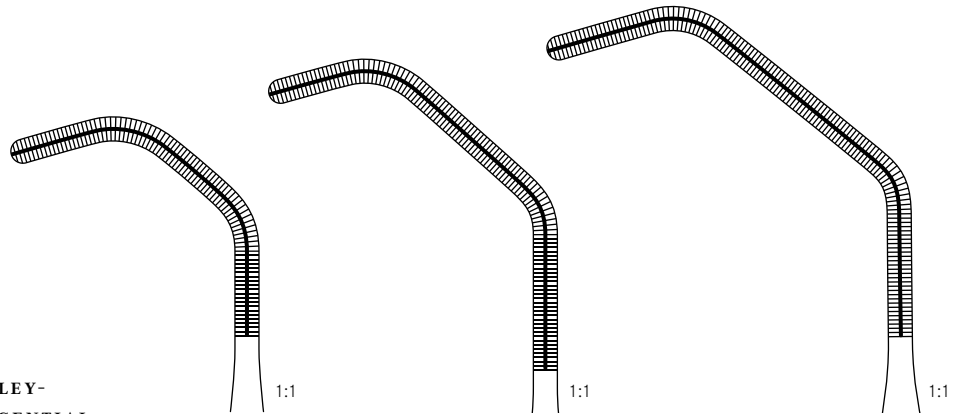

195 mm - 7 ³ / ₄ "	255 mm - 10"	260 mm - 10 ¹ / ₄ "
tk 22550-19	tk 22550-25	tk 22550-26

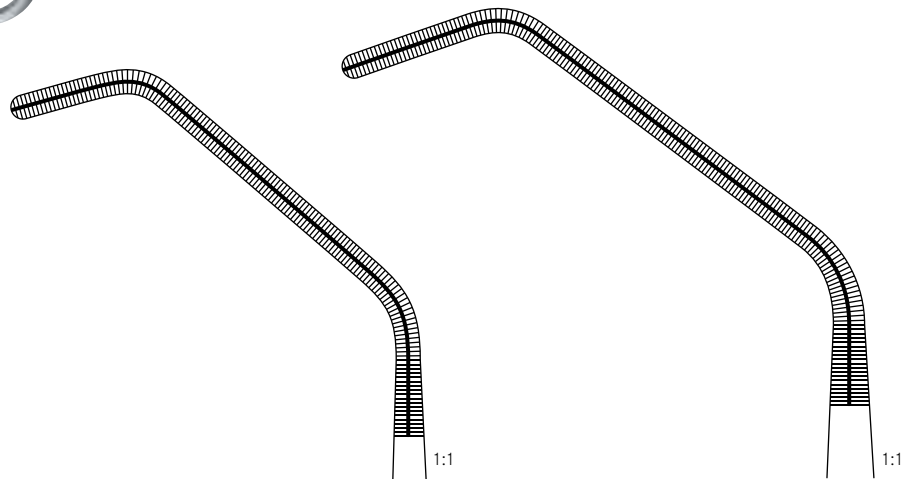

265 mm - 10 ¹ / ₂ "	270 mm - 10 ³ / ₄ "
tk 22550-27	tk 22550-28

Mehrzweckklemmen, pädiatrisch, graduert
Multi-purpose clamps, pediatric, graduated

Pinces polyvalentes, pédiatriques, graduées
Pinzas de uso vario, pediátricas, graduadas
Pinze multi uso, per bambini, graduati

ATRAUMTK

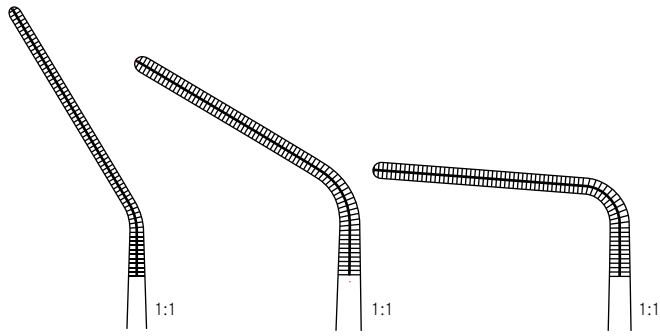

COOLEY

165 mm - 6½"	160 mm - 6¼"	145 mm - 5¾"
25°	45°	90°
tk 22500-17	tk 22501-15	tk 22502-15

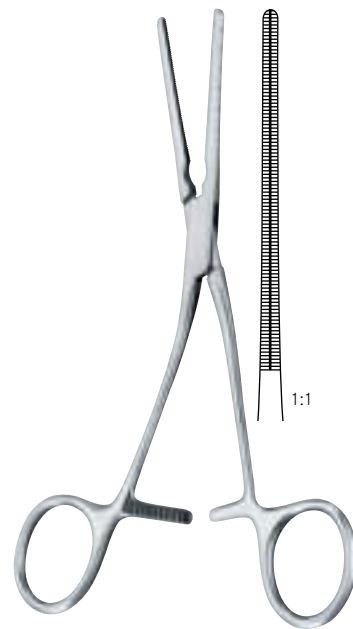
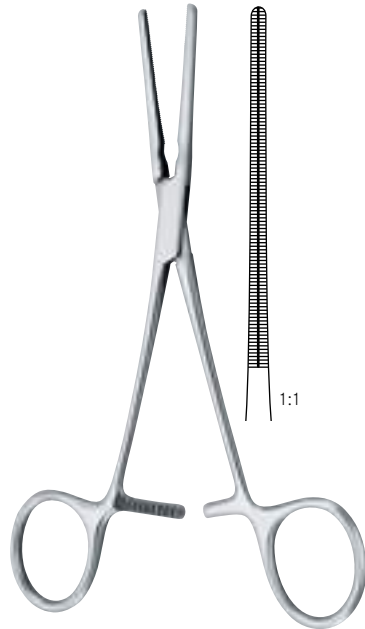

COOLEY

160 mm - 6¼"	tk 22520-01	tk 22607-16
170 mm - 6¾"	tk 22610-17	tk 22524-17
200 mm - 8"	tk 22610-20	
210 mm - 8¼"	tk 22507-21	
230 mm - 9"	tk 22610-23	tk 22607-23

abgewinkelt, graduert
angled on flat, graduated
coudée sur le plat, graduée
angulada, graduada
angolata, graduata

Mehrzweckklemmen, pädiatrisch, graduiert
 Multi-purpose clamps, pediatric, graduated

Pinces polyvalentes, pédiatriques, graduées
 Pinzas de uso vario, pediátricas, graduadas
 Pinze multi uso, per bambini, graduati

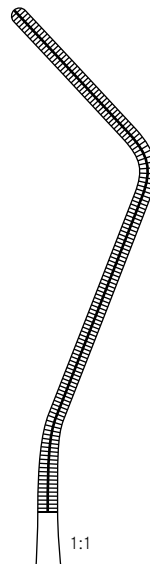
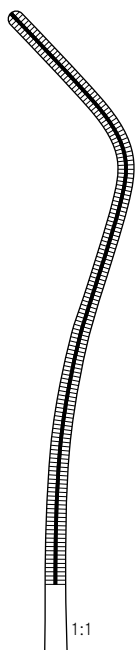
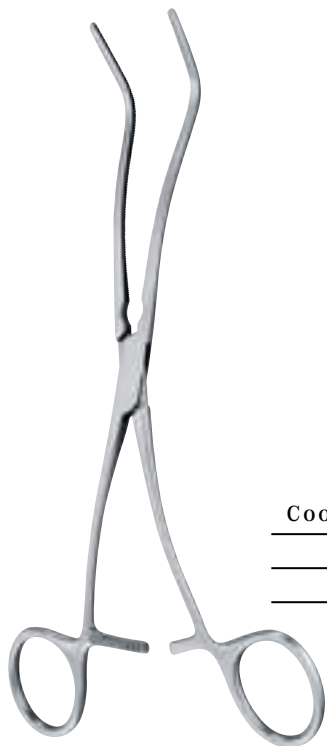

COOLEY

200 mm - 8"	195 mm - 7¾"
tk 22505-20	tk 22505-19

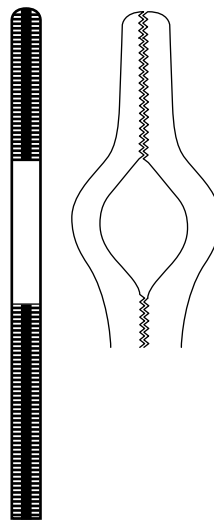

COOLEY

	160 mm - 6¼"	200 mm - 8"
x = 24 Charr.	tk 22506-24	-
x = 26 Charr.	tk 22506-26	-
x = 28 Charr.	-	tk 22506-28
x = 30 Charr.	-	tk 22506-30
x = 32 Charr.	-	tk 22506-32
x = 36 Charr.	-	tk 22506-36

Mehrzweckklemmen
Multi-purpose clamps

Pinces clamps polyvalentes
Pinzas clamps para usos varios
Pinze multi uso

ATRAUMTK

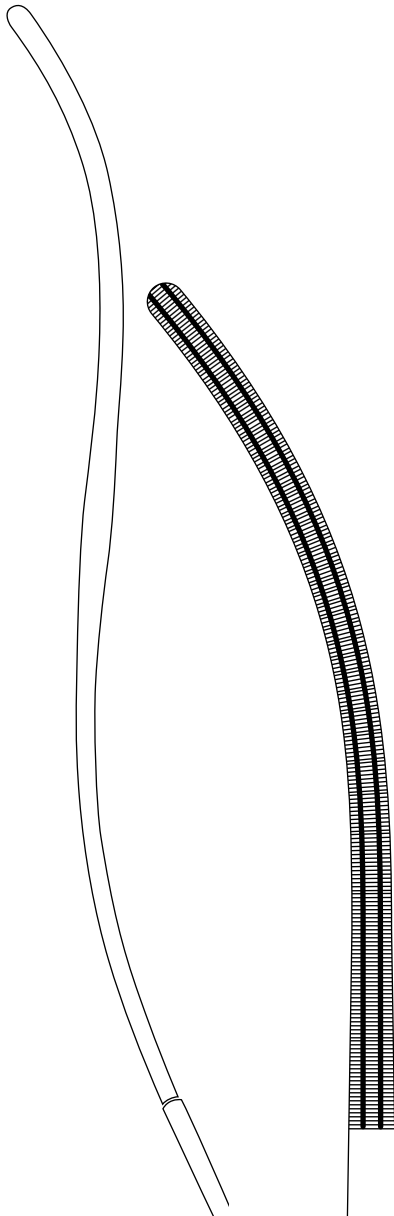

COOLEY
315 mm – 12½"
tk 22605-31

S-förmig gebogen
S-curved
courbe en S
curva en S
curva a forma S

1:1

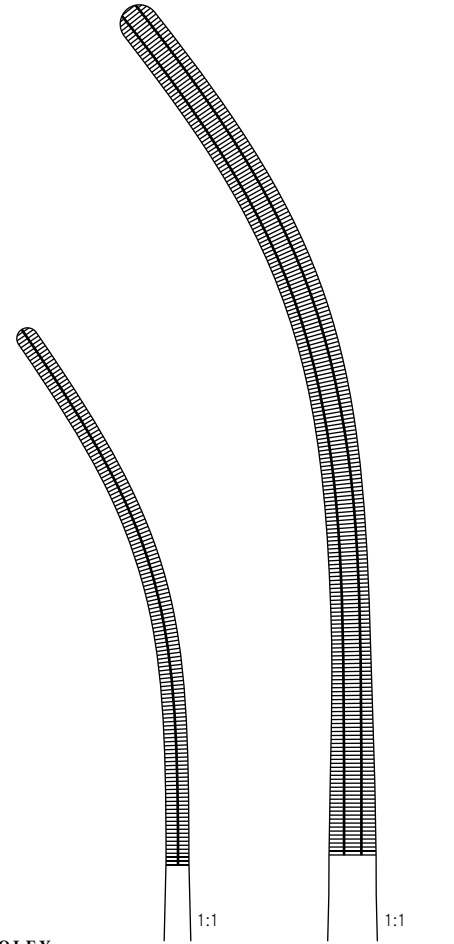

COOLEY

265 mm – 10½"	335 mm – 13¼"
tk 22600-26	tk 22600-33

1:1







1:1

Gefäß-Dilatatoren
Vascular dilators







Dilatateurs vasculaires
Dilatadores vasculares
Dilatatori vascolari



DE BAKEY





	 1:1	 1:1	 1:1	 1:1	 1:1	 1:1
	0.5 mm Ø	1.0 mm Ø	1.5 mm Ø	2.0 mm Ø	2.5 mm Ø	3.0 mm Ø
190 mm - 7½"	tk 24840-05	tk 24840-10	tk 24840-15	tk 24840-20	tk 24840-25	tk 24840-30
350 mm - 13¾"	tk 24841-05	tk 24841-10	tk 24841-15	tk 24841-20	tk 24841-25	tk 24841-30

biegsam
malleable
malléable
maleable
flessibile





	 1:1	 1:1	 1:1	 1:1	 1:1	 1:1
	3.5 mm Ø	4.0 mm Ø	4.5 mm Ø	5.0 mm Ø	7.0 mm Ø	9.0 mm Ø
190 mm - 7½"	tk 24840-35	tk 24840-40	tk 24840-45	tk 24840-50	tk 24840-70	tk 24840-90
350 mm - 13¾"	tk 24841-35	tk 24841-40	tk 24841-45	tk 24841-50	tk 24841-70	tk 24841-90



COOLEY

	 1:1	 1:1	 1:1	 1:1
	0.5 mm Ø	1.0 mm Ø	1.5 mm Ø	2.0 mm Ø
130 mm - 5"	tk 24844-05	tk 24844-10	tk 24844-15	tk 24844-20

biegsam
malleable
malléable
maleable
flessibile

	 1:1	 1:1	 1:1	 1:1
	2.5 mm Ø	3.0 mm Ø	4.0 mm Ø	5.0 mm Ø
130 mm - 5"	tk 24844-25	tk 24844-30	tk 24844-40	tk 24844-50



Verband | Pansements
Dressings | *Vendajes*
Bendaggi



Gipsinstrumente
Plaster instruments

Instruments pour plâtres
Instrumentos para vendajes enyesados
Strumenti per apparecchi gessati



ENGEL

1:2

140 mm - 5½"

tk 23100-14



BERGMANN

1:2

180 mm - 7"

tk 23110-18



HOPKINS

1:2

200 mm - 8"

tk 23120-20



ESMARCH

1:2

180 mm - 7"

tk 23160-18

Gipsinstrumente
Plaster instruments

Instruments pour plâtres
Instrumentos para vendajes enyesados
Strumenti per apparecchi gessati

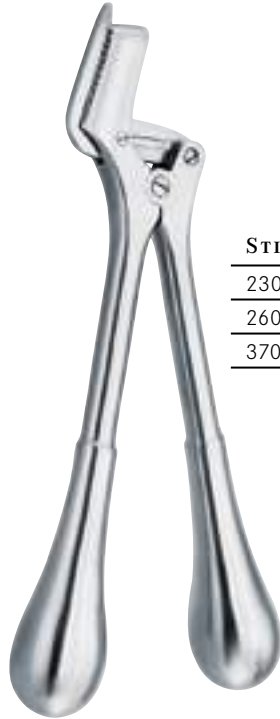

STILLE

230 mm - 9"	tk 23200-23
260 mm - 10 $\frac{1}{4}$ "	tk 23200-26
370 mm - 14 $\frac{1}{2}$ "	tk 23200-37

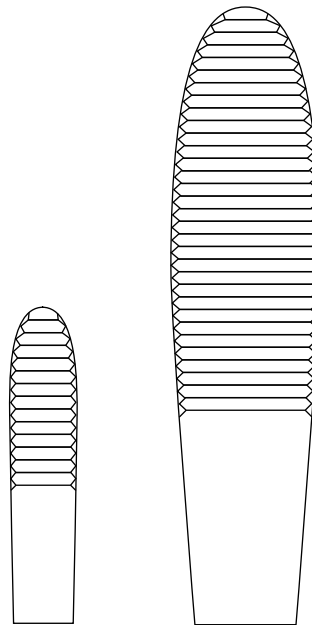

WOLF

180 mm - 7"	240 mm - 9 $\frac{1}{2}$ "
tk 23290-18	tk 23290-24



Gipsinstrumente
Plaster instruments

Instruments pour plâtres
Instrumentos para vendajes enyesados
Strumenti per apparecchi gessati



USA MODELL

230 mm - 9"

tk 23275-23

1:2



BEESON

300 mm - 12"

tk 23250-30

1:2



HENNIG

280 mm - 11"

tk 23270-28

1:2

Elektro Gipssäge TEKNO Power
Electric plaster saw TEKNO Power

Scie électrique TEKNO Power
Sierra electrica TEKNO Power
 Sega elettrica da gesso TEKNO Power



230V / 50 Hz	tk 24008-01
120V / 60 Hz	tk 24009-01

Komplett mit:

1 Sägeblatt Ø 50mm
 1 Sägeblatt Ø 65 mm
 1 Segmentsägeblatt
 1 Inbusschlüssel T
 Schmierstoffe
 5m Netzkabel(230V)
 3m Netzkabel (120V)
 Gabelschlüssel 11mm, 14mm
 Gebrauchsanleitung

Technische Daten:

Leistungsaufnahme 500W
 Gewicht 1,25 kg
 3500-24000 Schwingungen p. Minute
 Nur 52-77db(A)
 Motor doppelschutzisoliert (Klasse II)
 CE-Konform
 Geprüft nach EN60601-1 /-1-2

Complete with:

1 Sawblade Ø 50mm
 1 Sawblade Ø 65mm
 1 segment sawblade
 1 hollow screw wrench T
 Grease
 5m mains cable (230V)
 3m mains cable (120V)
 Wrenches 11mm, 14mm
 Instruction manual

Technical data:

Consumption 500W
 Weight 1,25kg
 3500-24000 osc per minute
 Only 52-77db (A)
 Double isolated protection of the engine (class II)
 According to CE
 Tested according to EN 60601-1/-1-2

Elektro Gipssäge TEKNO Power
Electric plaster saw TEKNO Power

Scie électrique TEKNO Power
Sierra eléctrica TEKNO Power
Sega elettrica da gesso TEKNO Power



Ø 50 mm	tk 24006-02
Ø 65 mm	tk 24006-03

Sägeblatt
Saw blade

Lame de scie
Hoja
Lama



Ø 45 mm	tk 24006-05S
Ø 50 mm	tk 24006-02S
Ø 65 mm	tk 24006-03S

Sägeblatt für synthetische Materialien
Saw blade for synthetic material

Lame pour scie pour matériau synthétique
Hoja de sierra para material sintético
Lama per sega per materiale sintetico

Complet avec:

1 Lame de Ø50mm
1 Lame de Ø65mm
1 scie á segmental
1 Clé pour vis hexagonales
Lubrifiant
5m Cable RED (230V)
3m Cable RED (120V)
Clés à fourche 11mm, 14mm
Mode d' emploi

Dates techniques:

Puissance absorbée 500W
Poids 1, 25 kg
3500-24000 oscillations par minute
52-77 db(A)
Double isolation du moteur (class II)
Conforme au CE
Testé selon EN 60601-1/-1-2

Completo con:

1 Hoja de Ø50mm
1 Hoja de Ø65mm
1 hoja de segmento
1 Llave para tornillos hexagonales
Lubrificante
5m Cable RED (230V)
3m Cable RED (120V)
Llaves de tuercas 11mm, 14mm
Manual de Usuario

Datos tecnicos:

Absorcion de potencia 500W
Peso 1,25 Kg
3500-24000 oscilaciones /min.
52-77 db(A)
Doble aislante del motor (clase II)
Conforme a las normas CE
Testado segun EN 60601-1/-1-2

Completa con:

1 Lama Ø50mm
1 Lama Ø65mm
1 Lama segmentale
1 chiave
Lubrificante
Cavo di alimentazione 5 metri (230V)
Cavo di alimentazione 3 metri (120V)
Chiavi di montaggio 11mm,14mm
Manuale di istruzione

Dati tecnici:

Asorbimento 500W
Peso 1,25kg
3500-24000 oscilazioni/min.
Solamente 52-77 db(A)
Doppio isolamento del motore (classe II)
In accord al marchio CE
EN 60601-1/-1-2

Gipsstaub-Absauganlage
Vacuum engine for plaster saws

 Aspirateur pour la poussière de plâtre
Sistema de aspiración para el polvo de yeso
 Aspiratore per sega da gesso

230V / 50Hz	tk 24006-06		
120V / 60Hz	tk 24007-06		
		Technische Daten: Saugmotor Dauerleistung 1100 W (max 1450 W) Maximale Gesamtleistung 1600 W Stufenlose Regelung 500 W - 1100 W Maximale Saugleistung (Motor) 2100 mm H ₂ O Effektive Saugleistung 1900 mm H ₂ O Maximale Durchflussleistung (Motor) 62 lt. /sek. mit allen Filtern: 40 lt. /sek. Geräuschentwicklung 63 - 69 db (A) HEPA Filter 99.97% (0.3 Mikron)	Technical data: Vacuum motor working power 1100 W (max 1450 W) Maximum total power 1600 W Infinitely setting 500 W - 1100 W Maximum vacuum capacity (motor) 2100 mm H ₂ O Actual vacuum capacity 1900 mm H ₂ O Maximum airflow (motor) 62 lt. /sek. with all filters: 40 lt. /sek. Noise level 63 - 69 db (A) HEPA filter 99.97% (0.3 micron)
		Einschaltautomatik mit Gipssäge Nachlaufzeit ca. 6 Sek. Antistatische Ausführung	Simultaneous start of saw and engine Automatic stop 6 sec. after the saw Antistatic system
230V / 50Hz	tk 24008-02		
120V / 60Hz	tk 24009-02		
		Komplettes Set TEKNO Power Gipssäge & Gipsstaub-Absauganlage	Complete Set TEKNO Power plaster saw & vacuum engine

Gipsstaub-Absauganlage
Vacuum engine for plaster saws

Aspirateur pour la poussière de plâtre
 Sistema de aspiración para el polvo de yeso
 Aspiratore per sega da gesso

230 V / 50 Hz	tk 24006-06	
120 V / 60 Hz	tk 24007-06	
Dates techniques: Moteur d'aspiration, Puissance permanente 1100 W (max 1450 W) Puissance maximale totale 1600 W Reglage continue de 500 W - 1100 W Capacité d'aspiration (moteur) 2100 mm H ₂ O Capacité d'aspiration effective 1900 mm H ₂ O Débit maximale (moteur) 62 L /sec avec tous les filtres: 40 L /sec 63 - 69 db (A) Filter HEPA 99.97% (0.3 micron)		Datos técnicos: Motor de aspiración con un rendimiento Permanente de 1100 W (max 1450 W) Rendimiento máximo total 1600 W Reglaje continuo de 500 W a 1100 W Capacidad de aspiración (motor) 2100 mm H ₂ O Capacidad de aspiración efectiva 1900 mm H ₂ O Caudal máximo (motor) 62 L /sec con todos los filtros: 40 L /sec Noise level 63 - 69 db (A) Filtros HEPA 99.97% (0.3 micron)
Démarrage automatique avec la scie oscillante Arrêt automatique 6 sec après la scie Boîtier antistatique		Arranque automatico junto con la sierra Apagado automatico 6 sec despues la sierra Caja antistatica

230 V / 50 Hz	tk 24008-02	
120 V / 60 Hz	tk 24009-02	
Jeu complet Scie électrique TEKNO Power avec aspirateur		Juego completo Sierra electrica TEKNO Power junto con el sistema de aspiración

230 V / 50 Hz	tk 24006-06	
120 V / 60 Hz	tk 24007-06	
Dati tecnici: Motore aspiratore potenza 1100 W (max 1450 W) Assorbimento massimo 1600 W Potenza variabile da 500 W a 1100 W Capacità di aspirazione massima (motore) 2100 mm H ₂ O Capacità effettiva 1900 mm H ₂ O Portata massima (motore) 62 lt /sec Portata con tutti filtri: 40 lt /sec Livello rumore 63 - 69 db Filtro HEPA 99.97% (0.3 micron)		
Automatismo di accensione insieme alla sega Spegnimento programmato dopo l'utilizzo della sega circa 6 sec. Sistema antistatico		

230 V / 50 Hz	tk 24008-02	
120 V / 60 Hz	tk 24009-02	
Set completo TEKNO Power sega da gesso + aspiratore		



Knochenchirurgie
Bone surgery

Chirurgie osseuse
Cirurgía ósea
Chirurgia ossea



Amputations- und Resektionssägen
Amputating and resection saws

Scies à amputation et résection
Sierra para amputación y resección
Seghe per amputazione



CHARRIÈRE

350 mm - 13³/₄"

tk 24001-35



12 mm

tk 24001-12

15 mm

tk 24001-15

Ersatzsägeblätter

Spare saw blades

Lames de rechange

Hojas de cambio

Lame di ricambio



**HELFERICH-
BIER**

390 mm - 15¹/₂"

tk 24002-39



3 mm

tk 24002-03

5 mm

tk 24002-05

7 mm

tk 24002-07

Ersatzsägeblätter

Spare saw blades

Lames de rechange

Hojas de cambio

Lame di ricambio

Amputations- und Resektionssägen
Amputating and resection saws

Scies à amputation et résection
Sierra para amputación y resección
Seghe per amputazione



SATTERLEE

310 mm - 12¼"

tk 24003-31



LANGENBECK

230 mm - 9"

tk 24004-23



CHARRIÈRE

270 mm - 10¾"

tk 24005-27

300 mm - 12"

tk 24005-30

340 mm - 13½"

tk 24005-34

Raspeln, Feilen
Rasps, files

Râpes, limes
Escofinas, limas
Raspe, lime

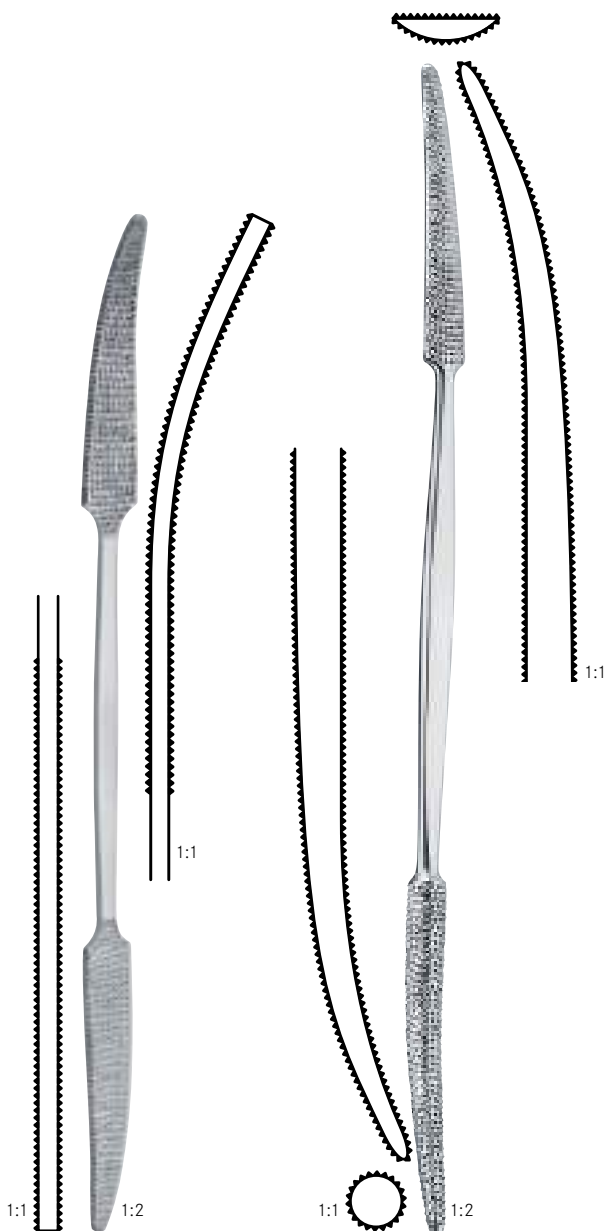

PUTTI

270 mm - 10 3/4"	tk 24011-27	
300 mm - 12"		tk 24010-30



280 mm - 11"	245 mm - 9 3/4"	220 mm - 8 3/4"
tk 24014-28	x = 13 mm	x = 20 mm
	tk 24015-24	tk 24016-22

halbrund
semicircular
semi-ronde
semi-redonda
semi-rotonda

halbrund
semicircular
semi-ronde
semi-redonda
semi-rotonda

flach
flat
plate
plana
piatta

Hämmer
Mallets

Maillets
Martillos
Martelli



DOYEN

	195 mm - 7 ³ / ₄ "
25 mm Ø - 120 g	tk 24025-21
30 mm Ø - 180 g	tk 24030-21
35 mm Ø - 260 g	tk 24035-21



COLLIN

	200 mm - 8 "
30 mm Ø - 220 g	tk 24051-20

1:2



HAJEK

	215 mm - 8 ¹ / ₂ "
27 mm Ø - 140 g	tk 24047-21

1:2



KIRK

	190 mm - 7 ¹ / ₂ "
38 mm Ø - 750 g	tk 24040-19

1:2

Hämmer | Maillets
 Mallets | Martillos
 Martelli



PARTSCH
 180 mm - 7"
 22 mm Ø - 200 g
tk 24053-18

1:2

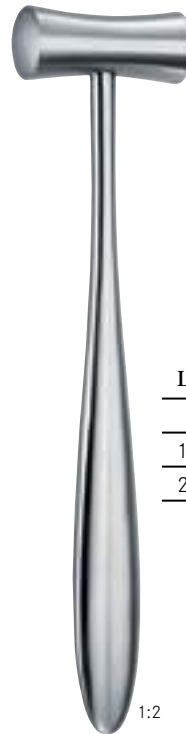

LUCAE
 190 mm - 7½"
 19 mm Ø - 230 g **tk 24057-01**
 25 mm Ø - 260 g **tk 24057-02**

1:2

Hämmer | Maillets
Mallets | Martillos
Martelli



1:2

BERGMANN

245 mm - 9¾"
45 mm Ø - 300 g
tk 24043-24



1:2

OMBREDANNE

240 mm - 9½"
40 mm Ø - 550 g
tk 24041-24



HEATH

40 mm Ø - 700 g	180 mm - 7"	tk 24044-18
45 mm Ø - 1000 g	200 mm - 8"	tk 24044-20

Kupferfüllung
Copper filled head
Rempli de cuivre
Llenado de cobre
Riempito di rame

Hämmer
Mallets

Maillets
Martillos
Martelli



190 mm - 7½"
 25 mm Ø - 205 g

tk 24056-19

Massiver Stahl, mit Kunststoffbacken
Solid steel, with plastic faces

Acier solid, avec plaques en plastique
Acero solido, con placas en plastica
Acciaio massiccio, con punte di plastica

tk 24056-90

Ersatzbacken, 1 Paar
Spare faces, 1 pair

Plaques de rechange, 1 paire
Placas de cambio, 1 par
Punte di ricambio, 1 paio



COTTLE

185 mm - 7¼"
 30 mm Ø - 240 g

tk 50581-19

1 Seite flach / 1 Seite convex
1 side flat / 1 side convex

1 coté plat / 1 coté convex
1 lato piano / 1 lato convesso



	280 mm - 11"
35 mm Ø - 450 g	tk 24036-01
50 mm Ø - 900 g	tk 24036-02

Hämmer | Maillets
Mallets | *Martillos*
 Martelli



WILLIGER

	240 mm - 9½"
28 mm Ø - 340 g	tk 24042-28
30 mm Ø - 400 g	tk 24042-30

bleigefüllt
lead filled

rempli de plomb
llenado con plomo
 riempito di piombo



1:2

WILLIGER

165 mm - 6½"
20 mm Ø - 140 g

tk 24055-16



1:2

MEAD

170 mm - 6¾"
26 mm Ø - 320 g

tk 24050-17

Stahl massiv, mit Kunststoffbacken
Steel solid, with plastic faces

Acier solid, avec plaques en plastique
Acero solido, con placas en plastica
 Acciaio massiccio, con punte di plastica

tk 24050-90

Ersatzbacken, 1 Paar
Spare faces, 1 pair

Plaques de rechange, 1 paire
Placas de cambio, 1 par
 Punte di ricambio, 1 paio

Hämmer
Mallets

Maillets
Martillos
Martelli



225 mm - 8¾"

37 mm Ø - 370 g

tk 24052-22

Kopf massiver Stahl, mit Ferrozellbacken
Head solid steel, with Ferrozell faces

Tête acier solid, avec plaques en Ferrozell
Cabeza acero sólido, con placas en Ferrozell
Testa acciaio massiccio, con punte di Ferrozell

tk 24052-90

Ersatzbacken, 1 Paar
Spare faces, 1 pair

Plaques de rechange, 1 paire
Placas de cambio, 1 par
Punte di ricambio, 1 paio



240 mm - 9½"

30 mm Ø - 480 g

tk 24059-24

Kopf massiver Stahl, mit Ferrozellstiel
Head solid steel, Ferrozell handle

Tête acier solid, manche en matière Ferrozell
Cabeza acero sólido, con mango en Ferrozell
Testa acciaio massiccio, con manico di Ferrozell

Hämmer | Maillets
Mallets | *Martillos*
 Martelli



1:2

	42 mm Ø - 250 g	42 mm Ø - 400 g
260 mm - 10 ¹ / ₄ "	tk 24045-26	tk 24046-26

Ferrozell, ohne Blei <i>Ferrozell, without lead</i>	Kunststoff, bleigefüllt <i>Plastic, lead filled</i>
Ferrozell, sans plomb <i>Ferrozell, sin plomo</i>	Matière plastique, rempli de plomb <i>Plastico, llenado con plomo</i>
Ferrozell, senza piombo	Plastica, riempito di piombo



1:2

	30 mm Ø - 450 g	50 mm Ø - 900 g
265 mm - 10 ¹ / ₂ "	tk 24054-01	tk 24054-02

Knochenmeißel
Bone chisels and gouges

Ciseaux-burins, gouges
Cinceles, gubias
Scalpelli, sgorbi

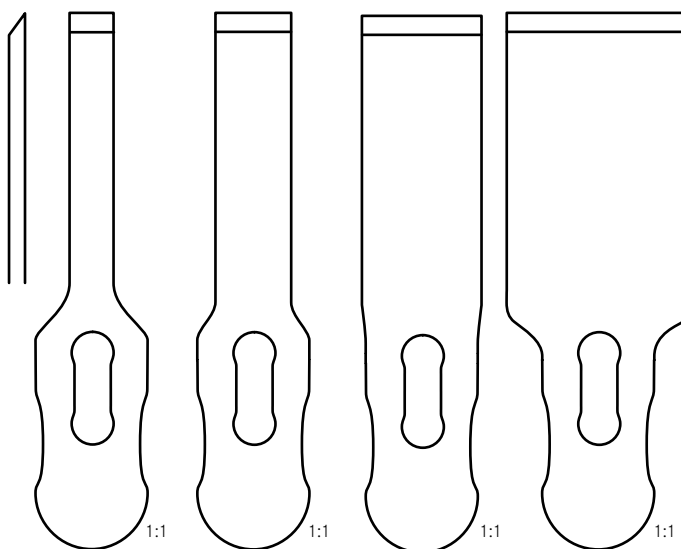

	5 mm	10 mm	16 mm	25 mm
85 mm - 3 1/4"	tk 24084-05	tk 24084-10	tk 24084-16	tk 24084-25

Meißelklingen, auswechselbar
Chisel blades, interchangeable

Lames ciseaux-burin, interchangeables
Hojas de cincel, intercambiables
Lame, intercambiabili



1:2

185 mm - 7 1/4"

tk 24084-00

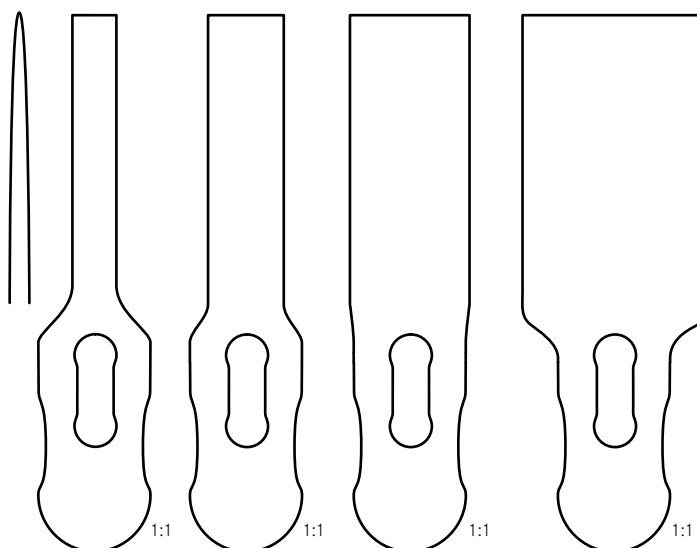

	5 mm	10 mm	16 mm	25 mm
85 mm - 3 1/4"	tk 24085-05	tk 24085-10	tk 24085-16	tk 24085-25

Osteotomklingen, auswechselbar
Osteotome blades, interchangeable

Lames d'osteotomos interchangeables
Hojas de osteótomo, intercambiables
Lame per osteotomia, intercambiabili



1:2

90 mm - 3 1/2"

tk 24084-01

Spannschlüssel

Key

Clé

Llave

Chiave

Knochenmeißel
Bone chisels and gouges

Ciseaux-burins, gouges
Cinceles, gubias
Scalpelli, sgorbi

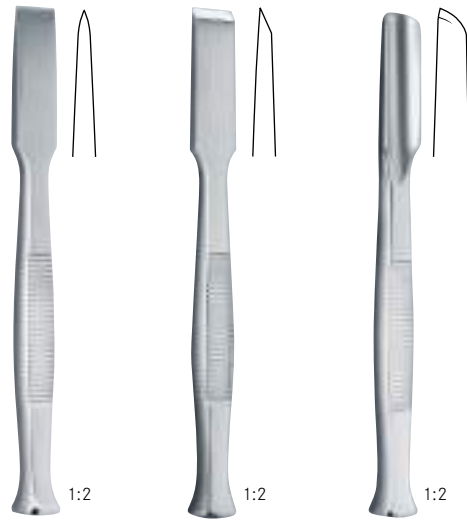

	135 mm - 5¼"	135 mm - 5¼"	135 mm - 5¼"
8 mm	tk 24060-08	tk 24062-08	tk 24064-08
10 mm	tk 24060-10	tk 24062-10	tk 24064-10
12 mm	tk 24060-12	tk 24062-12	tk 24064-12
14 mm	tk 24060-14	tk 24062-14	tk 24064-14
16 mm	tk 24060-16	tk 24062-16	tk 24064-16



LUCAS

	160 mm - 6¼"	160 mm - 6¼"
3 mm		tk 24228-03
4 mm	tk 24227-04	tk 24228-04
5 mm		tk 24228-05
6 mm	tk 24227-06	tk 24228-06

Flachmeißel
Chisel

Ciseau burin
Cinzel
Scalpello

Hohlmeißel
Gouge

Gouge
Gubia
Sgorbi



ALEXANDER

	180 mm - 7"	180 mm - 7"
4 mm	tk 24090-04	tk 24091-04
6 mm	tk 24090-06	tk 24091-06
8 mm	tk 24090-08	tk 24091-08
10 mm	tk 24090-10	tk 24091-10
12 mm	tk 24090-12	tk 24091-12
14 mm	tk 24090-14	tk 24091-14

Knochenmeißel
Bone chisels and gouges

Ciseaux-burins, gouges
Cinceles, gubias
Scalpelli, sgorbi



PARTSCH

	115 mm - 4½"	135 mm - 5¼"	170 mm - 6¾"
2 mm	tk 24111-02	tk 24113-02	tk 24117-02
3 mm	tk 24111-03	tk 24113-03	tk 24117-03
4 mm	tk 24111-04	tk 24113-04	tk 24117-04
5 mm	tk 24111-05	tk 24113-05	tk 24117-05
6 mm	tk 24111-06	tk 24113-06	tk 24117-06
7 mm	tk 24111-07	tk 24113-07	tk 24117-07
8 mm	tk 24111-08	tk 24113-08	tk 24117-08

	115 mm - 4½"	135 mm - 5¼"	170 mm - 6¾"
	tk 24211-02	tk 24213-02	tk 24217-02
	tk 24211-03	tk 24213-03	tk 24217-03
	tk 24211-04	tk 24213-04	tk 24217-04
	tk 24211-05	tk 24213-05	tk 24217-05
	tk 24211-06	tk 24213-06	tk 24217-06
	tk 24211-07	tk 24213-07	tk 24217-07
	tk 24211-08	tk 24213-08	tk 24217-08

Knochenmeißel
Bone chisels and gouges

Ciseaux-burins, gouges
Cinceles, gubias
Scalpelli, sgorbi



LAMBOTTE

	250 mm - 9¾"	250 mm - 9¾"
6 mm	tk 24092-06	tk 24093-06
8 mm	tk 24092-08	tk 24093-08
10 mm	tk 24092-10	tk 24093-10
13 mm	tk 24092-13	tk 24093-13
15 mm	tk 24092-15	tk 24093-15
20 mm	tk 24092-20	tk 24093-20
25 mm	tk 24092-25	tk 24093-25
30 mm	tk 24092-30	tk 24093-30
38 mm	tk 24092-38	tk 24093-38
44 mm	tk 24092-44	tk 24093-44
50 mm	tk 24092-50	tk 24093-50



MINI-LAMBOTTE

	125 mm - 5"	170 mm - 6¾"
3 mm	tk 24094-03	tk 24095-03
4 mm	tk 24094-04	tk 24095-04
6 mm	tk 24094-06	tk 24095-06
8 mm	tk 24094-08	tk 24095-08
10 mm	tk 24094-10	tk 24095-10
12 mm	tk 24094-12	tk 24095-12
15 mm	tk 24094-15	tk 24095-15

Knochenmeißel
Bone chisels and gouges

Ciseaux-burins, gouges
Cinceles, gubias
Scalpelli, sgorbi

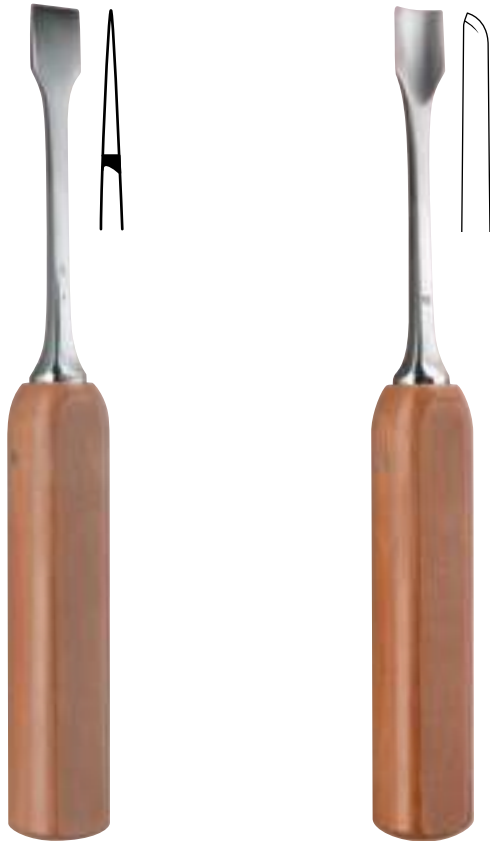

LEXER

MINI-LEXER

	220 mm - 8¾"	300 mm - 12"	220 mm - 8¾"	300 mm - 12"
7 mm	tk 24096-07	tk 24088-07	tk 24097-07	tk 24089-07
10 mm	tk 24096-10	tk 24088-10	tk 24097-10	tk 24089-10
15 mm	tk 24096-15	tk 24088-15	tk 24097-15	tk 24089-15
20 mm	tk 24096-20	tk 24088-20	tk 24097-20	tk 24089-20
25 mm	tk 24096-25	tk 24088-25	tk 24097-25	tk 24089-25
30 mm	tk 24096-30	tk 24088-30	tk 24097-30	tk 24089-30

	180 mm - 7"	180 mm - 7"
4 mm	tk 24086-04	tk 24087-04
6 mm	tk 24086-06	tk 24087-06
8 mm	tk 24086-08	tk 24087-08
10 mm	tk 24086-10	tk 24087-10
12 mm	tk 24086-12	tk 24087-12

Ferrozellgriff

Ferrozell handle

Manche en Ferrozell

Mango en Ferrozell

Manico di Ferrozell

Ferrozellgriff

Ferrozell handle

Manche en Ferrozell

Mango en Ferrozell

Manico di Ferrozell

Knochenmeißel
Bone chisels and gouges

Ciseaux-burins, gouges
Cinceles, gubias
Scalpelli, sgorbi

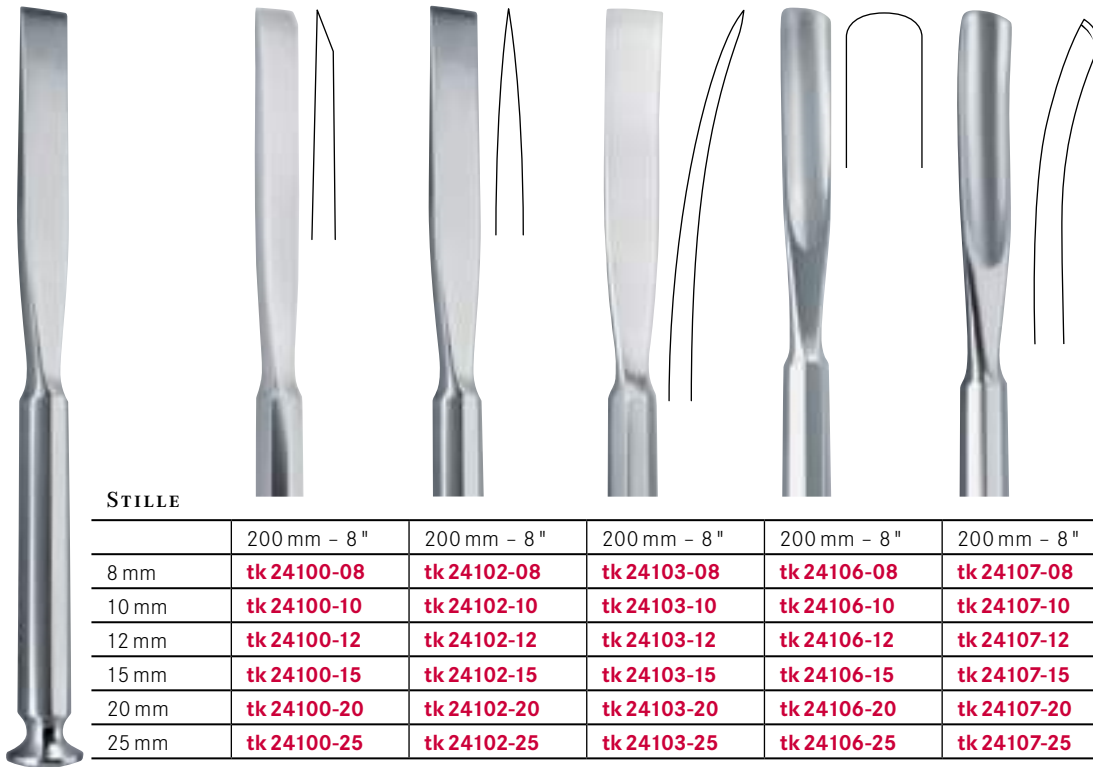

STILLE

	200 mm - 8"	200 mm - 8"	200 mm - 8"	200 mm - 8"	200 mm - 8"
8 mm	tk 24100-08	tk 24102-08	tk 24103-08	tk 24106-08	tk 24107-08
10 mm	tk 24100-10	tk 24102-10	tk 24103-10	tk 24106-10	tk 24107-10
12 mm	tk 24100-12	tk 24102-12	tk 24103-12	tk 24106-12	tk 24107-12
15 mm	tk 24100-15	tk 24102-15	tk 24103-15	tk 24106-15	tk 24107-15
20 mm	tk 24100-20	tk 24102-20	tk 24103-20	tk 24106-20	tk 24107-20
25 mm	tk 24100-25	tk 24102-25	tk 24103-25	tk 24106-25	tk 24107-25

1:2

Knochenmeißel
Bone chisels and gouges

Ciseaux-burins, gouges
Cinceles, gubias
Scalpelli, sgorbi

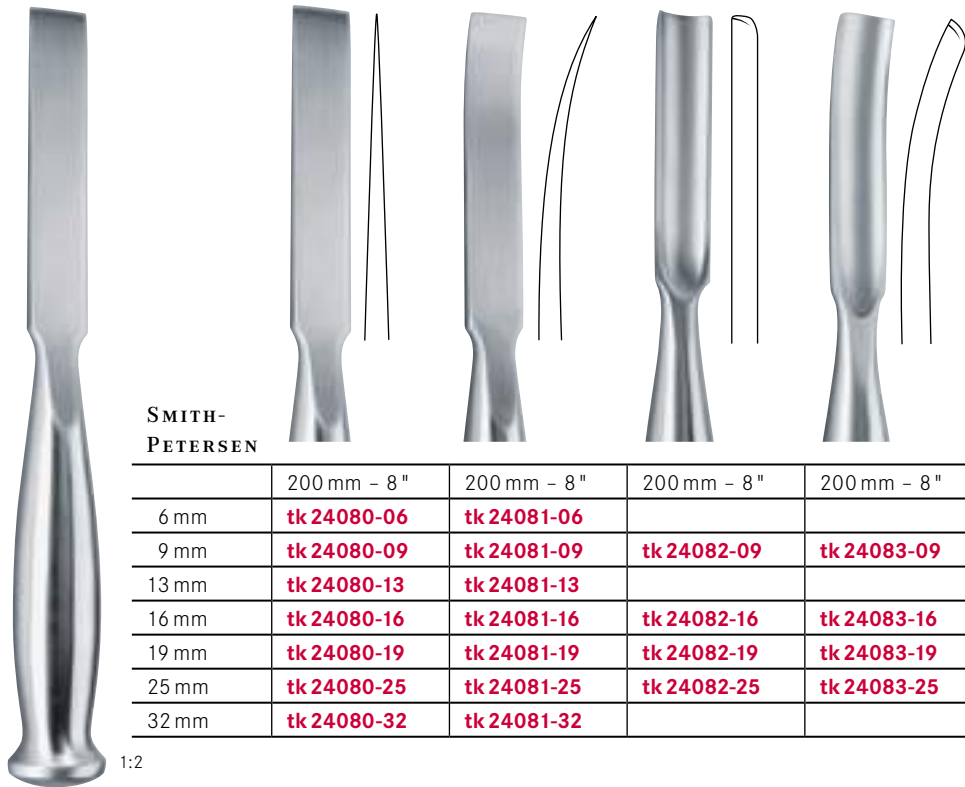

**SMITH-
PETERSEN**

	200 mm - 8"	200 mm - 8"	200 mm - 8"	200 mm - 8"
6 mm	tk 24080-06	tk 24081-06		
9 mm	tk 24080-09	tk 24081-09	tk 24082-09	tk 24083-09
13 mm	tk 24080-13	tk 24081-13		
16 mm	tk 24080-16	tk 24081-16	tk 24082-16	tk 24083-16
19 mm	tk 24080-19	tk 24081-19	tk 24082-19	tk 24083-19
25 mm	tk 24080-25	tk 24081-25	tk 24082-25	tk 24083-25
32 mm	tk 24080-32	tk 24081-32		

1:2

Knochenmeißel
Bone chisels and gouges

Ciseaux-burins, gouges
Cinceles, gubias
Scalpelli, sgorbi



HIBBS

	240 mm - 9 1/2"	240 mm - 9 1/2"	240 mm - 9 1/2"	240 mm - 9 1/2"	240 mm - 9 1/2"
6 mm	tk 24221-06	tk 24222-06	tk 24223-06	tk 24224-06	tk 24225-06
13 mm	tk 24221-13	tk 24222-13	tk 24223-13	tk 24224-13	tk 24225-13
19 mm	tk 24221-19	tk 24222-19	tk 24223-19	tk 24224-19	tk 24225-19
25 mm	tk 24221-25	tk 24222-25	tk 24223-25	tk 24224-25	tk 24225-25
32 mm	tk 24221-32	tk 24222-32	tk 24223-32	tk 24224-32	tk 24225-32

1:2

Knochenmeißel
Bone chisels and gouges

Ciseaux-burins, gouges
Cinceles, gubias
Scalpelli, sgorbi

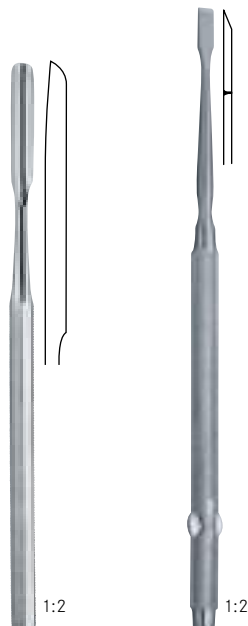

FREER		
	150 mm - 6"	160 mm - 6¼"
6 mm	tk 24251-15	
4 mm		tk 24252-16

Hohlmeißel	Flachmeißel
<i>Gouge</i>	<i>Chisel</i>
Gouge	Ciseau-burin
<i>Gubia</i>	<i>Cinzel</i>
Sgorbio	Scalpello



BALLENGER		
	160 mm - 6¼"	
4 mm	tk 24255-04	
6 mm	tk 24255-06	
8 mm	tk 24255-08	



**MANNERFELT
MODIF.**

	155 mm - 6"	155 mm - 6"
3 mm		tk 24254-03
4 mm	tk 24253-04	
6 mm	tk 24253-06	
8 mm	tk 24253-08	

Osteotome	Hohlmeißel
<i>Osteotomes</i>	<i>Gouge</i>
Ostéotomes	Gouge
<i>Osteótomos</i>	<i>Gubia</i>
Osteotomi	Sgorbio

Meißel zur Nasenplastik
Chisels, osteotomes for rhinoplastic

Ostéotomes, ciseaux-burins pour rhinoplastique
Cinceles para rinoplastica
Scalpelli per plastica nasale



KILIAN

160 mm - 6 1/4"

5 mm

tk 24261-16



KILIAN-CLAUS

160 mm - 6 1/4"

5 mm

tk 24263-16



COTTLE

150 mm - 6"

7 mm

tk 24270-07

12 mm

tk 24270-12



COTTLE

190 mm - 7 1/2"

4 mm

tk 24272-19

6 mm

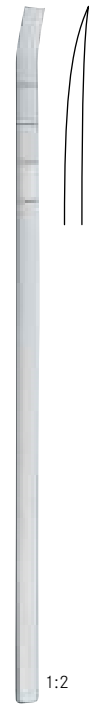

180 mm - 7"

tk 24277-06



FOMON

170 mm - 6 3/4"



4 mm

tk 24278-04



5 mm

tk 24278-05



6 mm

tk 24278-06

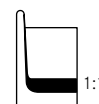

7 mm

tk 24278-07

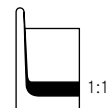

8 mm

tk 24278-08

Meißel zur Nasenplastik
Chisels, osteotomes for rhinoplastic

Ostéotomes, ciseaux-burins pour rhinoplastique
Cinceles para rinoplastica
Scalpelli per plastica nasale



1:2

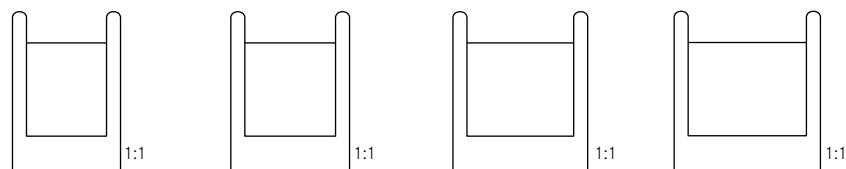

CINELLI

	10 mm	12 mm	14 mm	16 mm
180 mm - 7"	tk 24279-10	tk 24279-12	tk 24279-14	tk 24279-16



1:2



COTTLE

	4 mm	7 mm	9 mm	12 mm
180 mm - 7"	tk 24280-04	tk 24280-07	tk 24280-09	tk 24280-12



COTTLE

	4 mm	7 mm	9 mm	12 mm
180 mm - 7"	tk 24281-04	tk 24281-07	tk 24281-09	tk 24281-12

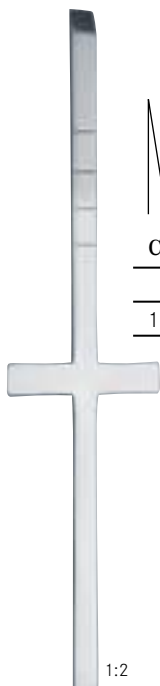

1:2

Meißel zur Nasenplastik
Chisels, osteotomes for rhinoplastic

Ostéotomes, ciseaux-burins pour rhinoplastique
Cinceles para rinoplastica
Scalpelli per plastica nasale

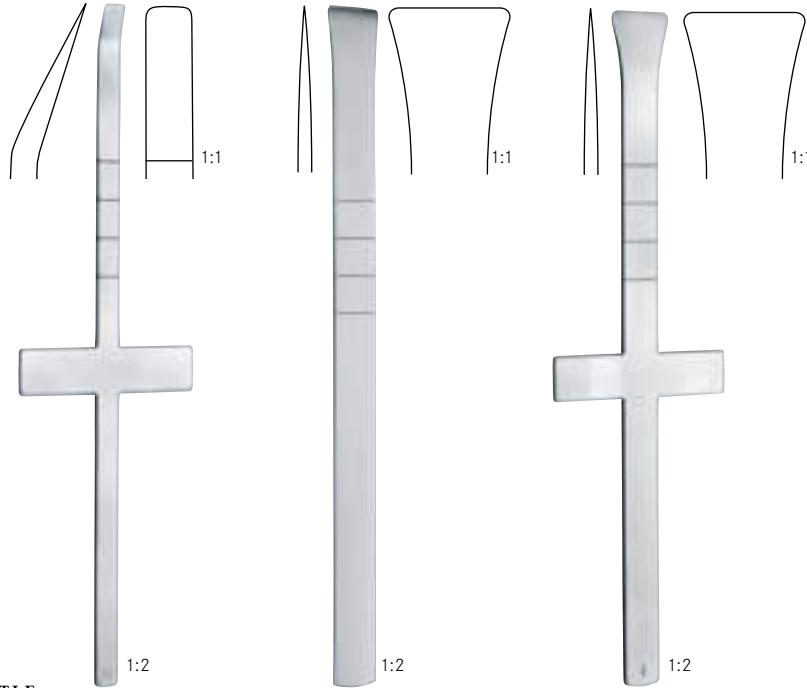

COTLE

	6 mm	16 mm	16 mm
180 mm - 7"	tk 24283-06	tk 24284-16	tk 24286-16



RUBIN





	10 mm	12 mm	14 mm
180 mm - 7"	tk 24290-10	tk 24290-12	tk 24290-14

Meißel zur Nasenplastik
Chisels, osteotomes for rhinoplastic

Ostéotomes, ciseaux-burins pour rhinoplastique
Cinceles para rinoplastica
Scalpelli per plastica nasale





1:2

COTTLE	 1:1	 1:1	 1:1	 1:1
	200 mm - 8"	4 mm tk 24287-04	7 mm tk 24287-07	9 mm tk 24287-09











1:2

WALTER	 1:1	 1:1
	190 mm - 7½"	3 mm tk 24292-03



1:2

SHEEHAN	 1:1	 1:1	 1:1	 1:1
	160 mm - 6¼"	2 mm tk 24295-02	4 mm tk 24295-04	6 mm tk 24295-06

	 1:1	 1:1	 1:1	 1:1
		10 mm tk 24295-10	12 mm tk 24295-12	15 mm tk 24295-15

Meißel zur Nasenplastik
Chisels, osteotomes for rhinoplastic

Ostéotomes, ciseaux-burins pour rhinoplastique
Cinceles para rinoplastica
ScalPELLI per plastica nasale



1:2

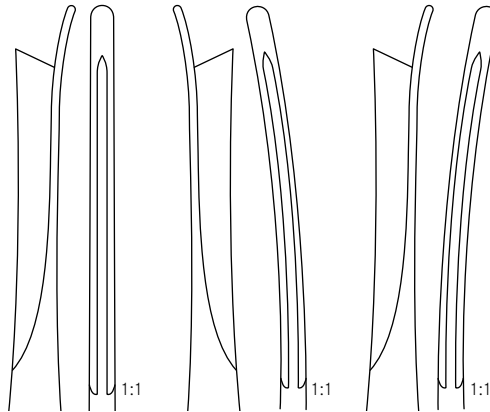

SILVER

180 mm - 7"	tk 24296-01	tk 24296-02	tk 24296-03
gerade straight	rechts right	links left	
droit recta retta	droite derecha destra	gauche izquierda sinistra	



1:2

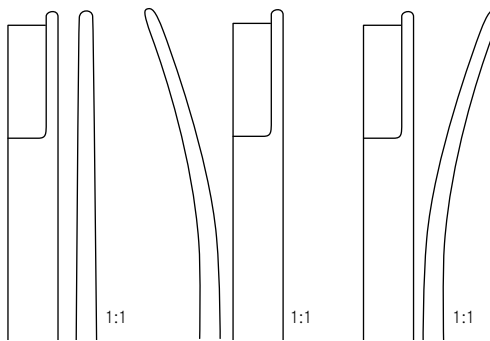

NEIVERT-ANDERSON

200 mm - 8"	tk 24298-01	tk 24298-02	tk 24298-03
gerade straight	rechts right	links left	
droit recta retta	droite derecha destra	gauche izquierda sinistra	

Meißel für die Kieferchirurgie
Osteotomes for maxillo-facial surgery

Ostéotomes pour la chirurgie maxillo-faciale
Cinceles para la cirugía maxilofacial
Scalpelli per chirurgia massilofaciale



OBWEGESER

235 mm - 9 1/4"

11 mm

tk 52744-24

1:2



OBWEGESER

7 mm

10 mm

215 mm - 8 1/2"

tk 52755-21

tk 52756-21

1:2

1:2







Stößel | Piloni
Tampers | Punzones
 Pestoni





1:2



1:2

	 1:1	 1:1	 1:1	 1:1	 1:1	 1:1	 1:1
	2 mm Ø	3 mm Ø	4 mm Ø	5 mm Ø	6 mm Ø	8 mm Ø	10 mm Ø
155 mm - 6"	tk 24250-02	tk 24250-03	tk 24250-04	tk 24250-05	tk 24250-06	tk 24250-08	tk 24250-10

PASSOW

	 1:1	 1:1
	Fig. 1	Fig. 2
	2.5 mm x 2.5 mm	3.5 mm x 3.5 mm
120 mm - 4 3/4"	tk 24239-11	tk 24239-12









1:2



1:2

CASPAR





	 1:1	 1:1	 1:1
	3 mm Ø	5 mm Ø	8 mm Ø
200 mm - 8"	tk 24248-03	tk 24248-05	tk 24248-08





	 1:1	 1:1	 1:1
	12 mm Ø	14 mm Ø	16 mm Ø
200 mm - 8"	tk 24249-12	tk 24249-14	tk 24249-16

Scharfe Löffel
Bone currettes

Curettes tranchantes
Cucharillas cortantes
Cucchiai taglianti









VOLKMANN	 1:1	 1:1	 1:1	 1:1	 1:1
	Fig. 0000	Fig. 000	Fig. 00	Fig. 0	Fig. 1
170 mm - 6 ³ / ₄ "	tk 24450-40	tk 24450-30	tk 24450-20	tk 24450-10	tk 24450-01

 1:1	 1:1	 1:1	 1:1	 1:1
Fig. 2	Fig. 3	Fig. 4	Fig. 5	Fig. 6
tk 24450-02	tk 24450-03	tk 24450-04	tk 24450-05	tk 24450-06

1:2



SCHEDE	 1:1	 1:1	 1:1	 1:1	 1:1
	Fig. 000	Fig. 00	Fig. 0	Fig. 1	Fig. 2
170 mm - 6 ³ / ₄ "	tk 24451-30	tk 24451-20	tk 24451-10	tk 24451-01	tk 24451-02



 1:1	 1:1
Fig. 3	Fig. 4
tk 24451-03	tk 24451-04



1:2



Scharfe Löffel
Bone curettes

Curettes tranchantes
Cucharillas cortantes
Cucchiai taglienti









SPRATT	 1:1	 1:1	 1:1
Fig. 0000	Fig. 000	Fig. 00	
170 mm - 6 ³ / ₄ "	tk 24461-40	tk 24461-30	tk 24461-20



	 1:1	 1:1	 1:1
Fig. 0	Fig. 1	Fig. 2	
tk 24461-10	tk 24461-01	tk 24461-02	

	 1:1	 1:1	 1:1
Fig. 3	Fig. 4	Fig. 5	
tk 24461-03	tk 24461-04	tk 24461-05	



BRUNS	 1:1	 1:1	 1:1
Fig. 000	Fig. 00	Fig. 0	
160 mm - 6 ¹ / ₄ "	tk 24460-30	tk 24460-20	tk 24460-10

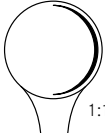





	 1:1	 1:1	 1:1
Fig. 1	Fig. 2	Fig. 3	
tk 24460-01	tk 24460-02	tk 24460-03	

	 1:1	 1:1	 1:1
Fig. 4	Fig. 5	Fig. 6	
tk 24460-04	tk 24460-05	tk 24460-06	





Scharfe Löffel
Bone curettes





Curettes tranchantes
Cucharillas cortantes
Cucchiai taglianti



	 1:1	 1:1	 1:1	 1:1	 1:1	 1:1
VOLKMANN	Fig. 0000	Fig. 000	Fig. 00	Fig. 0	Fig. 1	Fig. 2
185 mm - 7 1/4"	tk 24442-40	tk 24442-30	tk 24442-20	tk 24442-10	tk 24442-01	tk 24442-02

oval, mit Kunststoffgriff
oval, with plastic handle
ovale, avec manche en matière plastique
ovalada, con mango plástico
ovale, con manico in plastica

	 1:1	 1:1	 1:1	 1:1
	Fig. 3	Fig. 4	Fig. 5	Fig. 6
190 mm - 7 1/2"	tk 24442-03	tk 24442-04	tk 24442-05	tk 24442-06

	 1:1	 1:1	 1:1	 1:1	 1:1
	Fig. 0	Fig. 1	Fig. 2	Fig. 3	Fig. 4
275 mm - 10 3/4"	tk 24443-00	tk 24443-01	tk 24443-02	tk 24443-03	tk 24443-04





Scharfe Löffel
Bone curettes

Curettes tranchantes
Cucharillas cortantes
Cucchiai taglienti







1:2







BRUNS	 1:1	 1:1	 1:1	 1:1	 1:1
	Fig. 0000	Fig. 000	Fig. 00	Fig. 0	Fig. 1
230 mm - 9"	tk 24471-00	tk 24471-01	tk 24471-02	tk 24472-00	tk 24472-01





gerade
straight
droit
recta
retto

BRUNS	 1:1	 1:1	 1:1	 1:1	 1:1
	Fig. 2	Fig. 3	Fig. 4	Fig. 5	Fig. 6
230 mm - 9"	tk 24472-02	tk 24472-03	tk 24472-04	tk 24472-05	tk 24472-06

gerade
straight
droit
recta
retto

BRUNS	 1:1	 1:1	 1:1	 1:1	 1:1
	Fig. 0000	Fig. 000	Fig. 00	Fig. 0	Fig. 1
230 mm - 9"	tk 24473-00	tk 24473-01	tk 24473-02	tk 24474-00	tk 24474-01

gebogen
curved
courbe
curva
curvo

BRUNS	 1:1	 1:1	 1:1	 1:1	 1:1
	Fig. 2	Fig. 3	Fig. 4	Fig. 5	Fig. 6
230 mm - 9"	tk 24474-02	tk 24474-03	tk 24474-04	tk 24474-05	tk 24474-06

gebogen
curved
courbe
curva
curvo

Scharfe Löffel
Bone curettes

Curettes tranchantes
Cucharillas cortantes
Cucchiai taglianti



HALLE

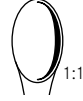
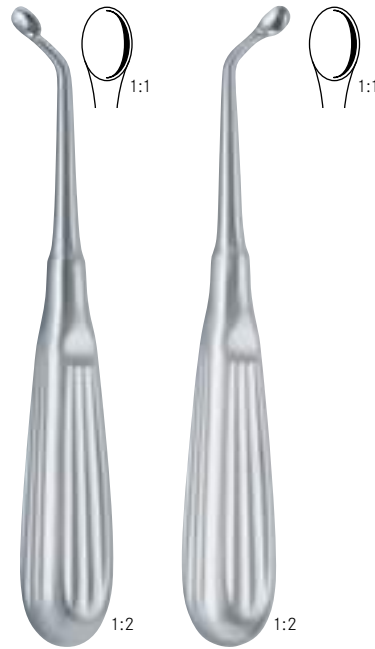

	Fig. 1	Fig. 2	Fig. 3
210 mm - 8 1/4"	tk 24462-01	tk 24462-02	tk 24462-03

flexibel
flexible
flexible
flexible
flessibile



UFFENORDE

	Fig. 1	Fig. 2
170 mm - 6 3/4"	tk 24463-01	tk 24463-02



BRUNS



	Fig. 00	Fig. 0	Fig. 1	Fig. 2
230 mm - 9"	tk 24464-20	tk 24464-10	tk 24464-01	tk 24464-02

massiv
solid
solide
macizo
massiccio

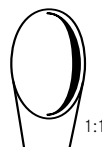
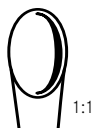

Fig. 3	Fig. 4	Fig. 5	Fig. 6
tk 24464-03	tk 24464-04	tk 24464-05	tk 24464-06

Scharfe Löffel
Bone curettes

Curettes tranchantes
Cucharillas cortantes
Cucchiai taglienti



SCHROEDER

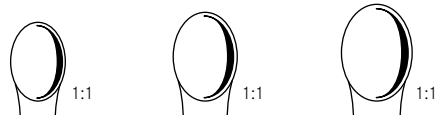

	Fig. 1	Fig. 2	Fig. 3
300 mm - 12"	tk 24448-01	tk 24448-02	tk 24448-03

scharf / fest
sharp / rigid
tranchante / rigide
cortante / rigida
tagliente / rigido

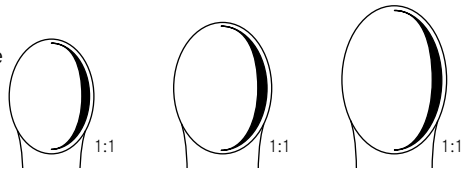

Fig. 4	Fig. 5	Fig. 6
tk 24448-04	tk 24448-05	tk 24448-06



SIMON



	Fig. 0000	Fig. 000	Fig. 00	Fig. 0
240 mm - 9 1/2"	tk 24440-40	tk 24440-30	tk 24440-20	tk 24440-10

scharf / fest
sharp / rigid
tranchante / rigide
cortante / rigida
tagliente / rigido

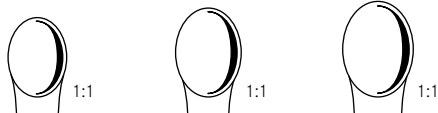

SIMON

	Fig. 1	Fig. 2	Fig. 3
250 mm - 9 3/4"	tk 24445-01	tk 24445-02	tk 24445-03

scharf / fest
sharp / rigid
tranchante / rigide
cortante / rigida
tagliente / rigido

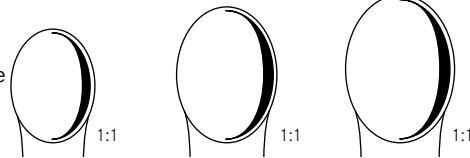

Fig. 4	Fig. 5	Fig. 6
tk 24445-04	tk 24445-05	tk 24445-06

Scharfe Löffel
Bone currettes

Curettes tranchantes
Cucharillas cortantes
Cucchiai taglianti



1:2



	Fig. 000	Fig. 00	Fig. 0
200 mm - 8"	tk 24390-30	tk 24390-20	tk 24390-10

gerade
straight
droit
recta
retto



Fig. 1	Fig. 2	Fig. 3
tk 24390-01	tk 24390-02	tk 24390-03

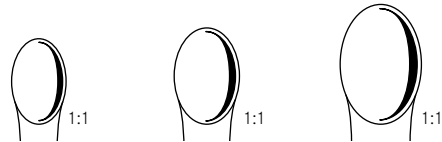

Fig. 4	Fig. 5	Fig. 6
tk 24390-04	tk 24390-05	tk 24390-06



1:2



	Fig. 000	Fig. 00	Fig. 0
200 mm - 8"	tk 24391-30	tk 24391-20	tk 24391-10

gebogen
curved
courbe
curva
curvo



Fig. 1	Fig. 2	Fig. 3
tk 24391-01	tk 24391-02	tk 24391-03

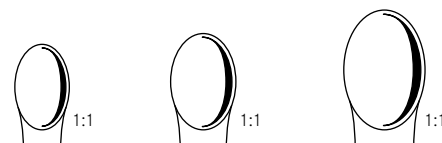

Fig. 4	Fig. 5	Fig. 6
tk 24391-04	tk 24391-05	tk 24391-06

Scharfe Löffel
Bone curettes

Curettes tranchantes
Cucharillas cortantes
Cucchiai taglienti



1:2

gerade
straight
droit
recta
retto



	Fig. 000	Fig. 00	Fig. 0	Fig. 1
	3.6 mm	4.4 mm	5.2 mm	6.8 mm
250 mm - 9 ³ / ₄ "	tk 24392-30	tk 24392-20	tk 24392-10	tk 24392-01



1:2

DAUBENSPECK



	Fig. 0000	Fig. 000	Fig. 00	Fig. 0
	2.8 mm	3.6 mm	4.4 mm	5.2 mm
200 mm - 8"	tk 24394-40	tk 24394-30	tk 24394-20	tk 24394-10

Scharfe Löffel
Bone currettes

Curettes tranchantes
Cucharillas cortantes
Cucchiai taglianti



SCOVILLE



	Fig. 1	Fig. 2	Fig. 3
250 mm - 9¾"	tk 24465-01	tk 24465-02	tk 24465-03

oval
oval
ovale
ovalada
ovale

1:2



LEMPERT

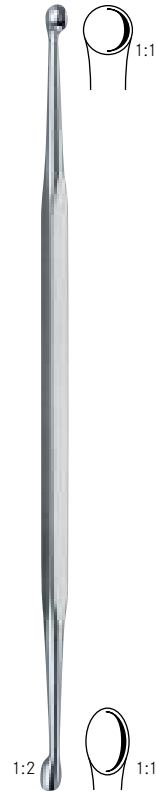

	Fig. 00000	Fig. 0000	Fig. 000	Fig. 00	Fig. 0
	1.8 mm	2.0 mm	2.4 mm	2.6 mm	2.8 mm
215 mm - 8½"	tk 24395-50	tk 24395-40	tk 24395-30	tk 24395-20	tk 24395-10

1:2

Scharfe Doppellöffel
Bone curettes, double-ended

Curettes doubles
Cucharillas de doble extremo
Curette doppia



VOLKMANN

130 mm - 5"	tk 24400-13	tk 24410-13
140 mm - 5½"	tk 24400-14	
160 mm - 6¼"		tk 24410-16
170 mm - 6¾"	tk 24400-17	
200 mm - 8"		tk 24410-20

oval / oval
oval / oval
ovale / ovale
ovalada / ovalada
ovale / ovale

rund / oval
round / oval
ronde / ovale
redonda / ovalada
rotondo / ovale

210 mm - 8¼"

tk 24412-21

rund / oval
round / oval
ronde / ovale
redonda / ovalada
rotondo / ovale

Scharfe Doppellöffel
Bone curettes, double-ended

Curettes doubles
Cucharillas de doble extremo
Curette doppia



1:2

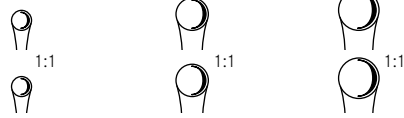

MARTINI

	Fig. 00	Fig. 0	Fig. 1
	Fig. 0	Fig. 1	Fig. 2
135 mm - 5 1/4"	tk 24485-00	tk 24485-01	tk 24485-12



1:2

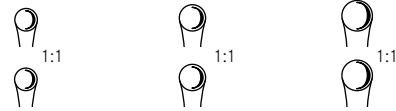

MARTINI

	Fig. 00	Fig. 0	Fig. 1
	Fig. 00	Fig. 0	Fig. 1
155 mm - 6"	tk 24489-20	tk 24489-10	tk 24489-01



1:2

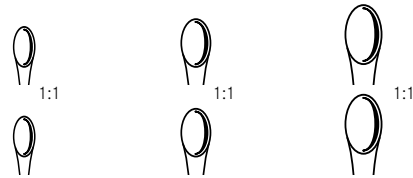

WILLIGER

	Fig. 00	Fig. 0	Fig. 1
	Fig. 0	Fig. 1	Fig. 2
135 mm - 5 1/4"	tk 24487-00	tk 24487-01	tk 24487-12



1:2

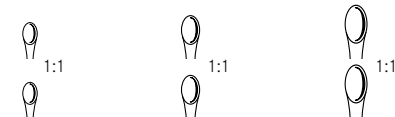

WILLIGER

	Fig. 00	Fig. 0	Fig. 1
	Fig. 00	Fig. 0	Fig. 1
155 mm - 6"	tk 24490-20	tk 24490-10	tk 24490-01

Raspatorien für die Kieferchirurgie
Periosteal elevators for maxillo-facial surgery

Rugines - Décolleurs pour la chirurgie maxillo-faciale
Periostótomos para la cirugía maxilofacial
Rasparatori per chirurgia massilofaciale

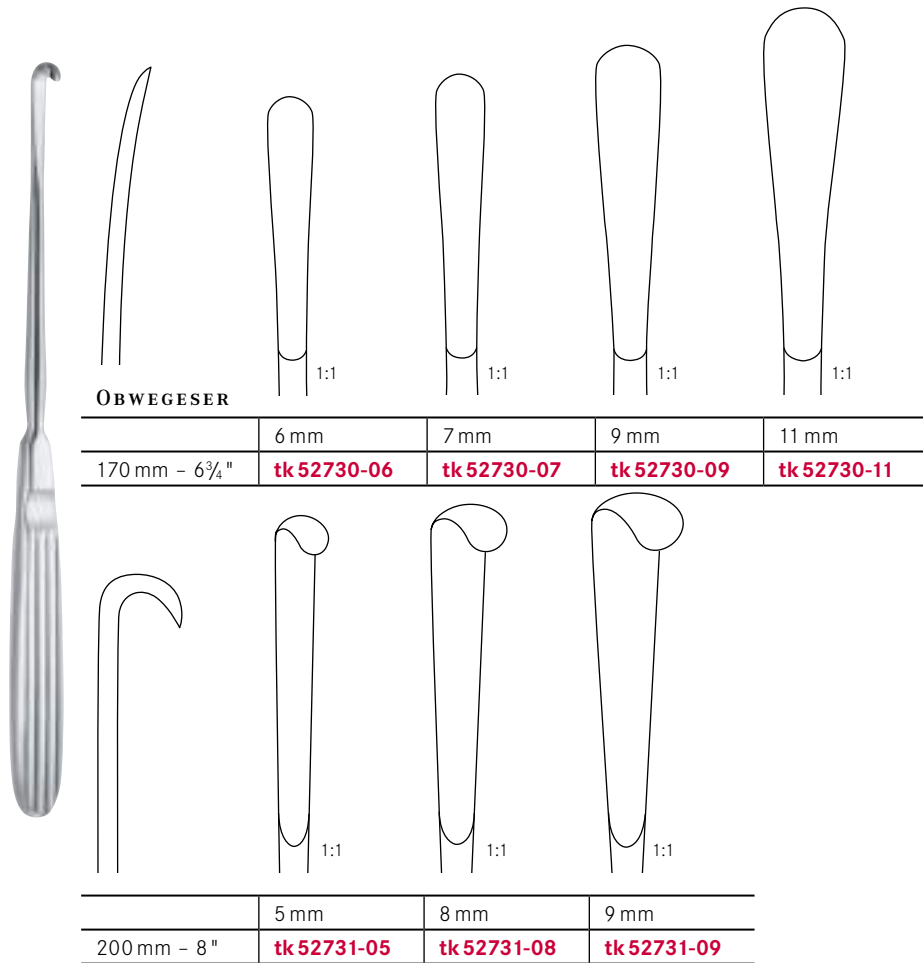

Raspatorien und Ahlen für die Kieferchirurgie
Periosteal elevators and awls for maxillo-facial surgery

Rugines, décolleurs et passe-fils pour chirurgie maxillo-faciale
Periostótomos y leznas para la cirugía maxilofacial
 Raspatori, punteruoli per chirurgia massilofaciale

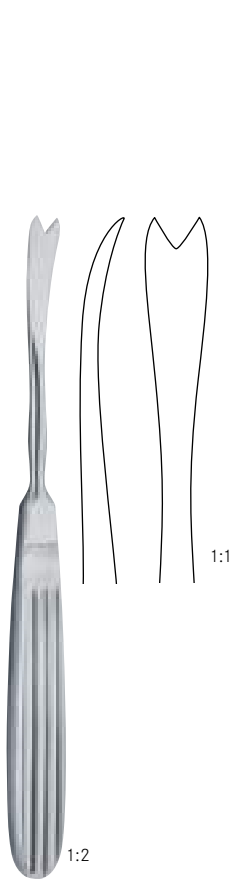

OBWEGESER
 175 mm - 7"
tk 52735-01



OBWEGESER
 230 mm - 9"
tk 52751-23



OBWEGESER
 180 mm - 7"
tk 52749-18



OBWEGESER
 140 mm - 5½"
tk 52750-14

Raspatorien – Elevatorien
Periosteal raspatories – Elevators

Rugines – Elevateurs
Raspatorios – Elevadores
Periostotomi – Elevatori

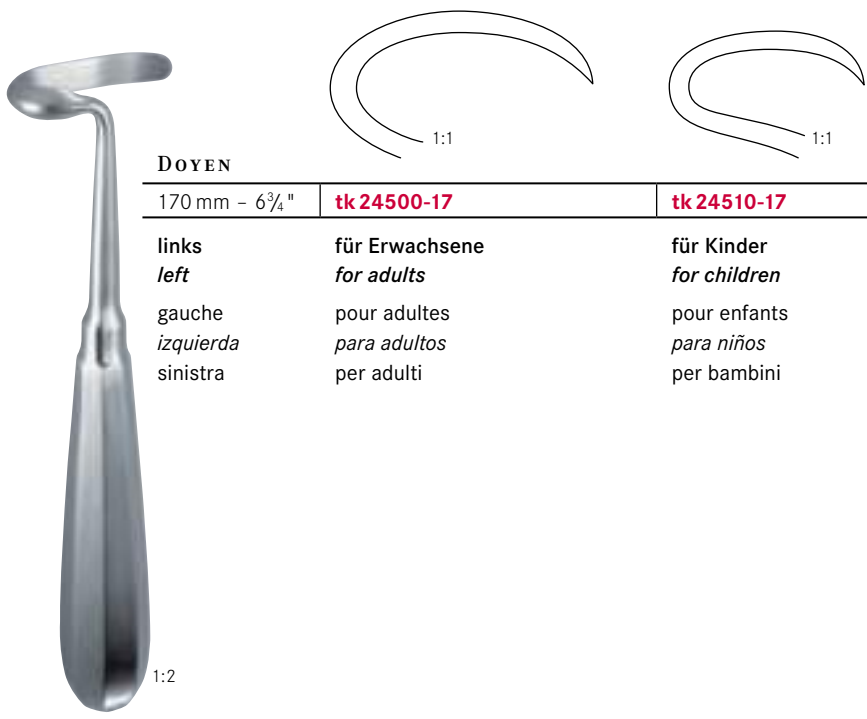

DOYEN		
170 mm – 6¾"	tk 24500-17	tk 24510-17
links <i>left</i> gauche <i>izquierda</i> sinistra	für Erwachsene <i>for adults</i> pour adultes <i>para adultos</i> per adulti	für Kinder <i>for children</i> pour enfants <i>para niños</i> per bambini

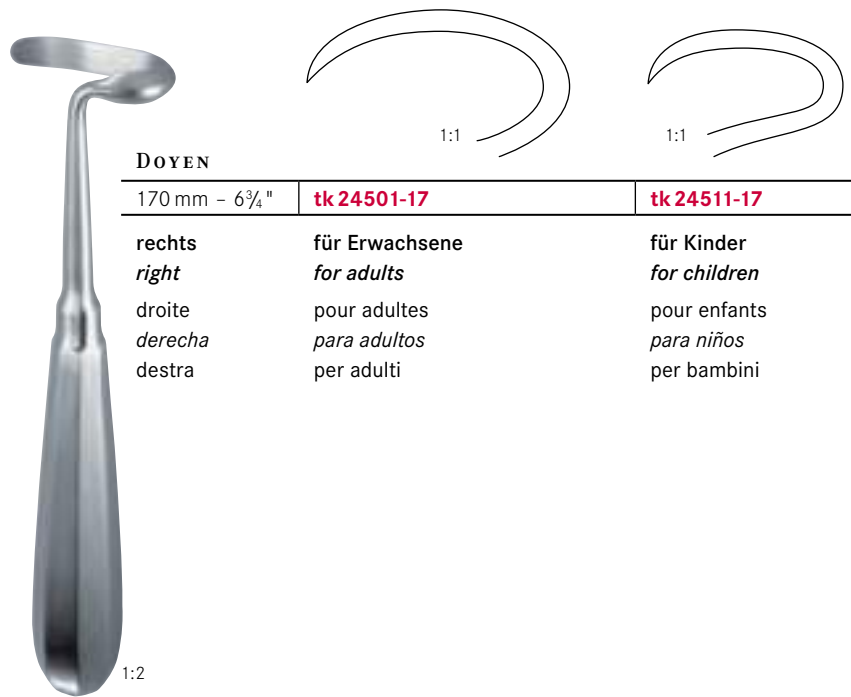

DOYEN		
170 mm – 6¾"	tk 24501-17	tk 24511-17
rechts <i>right</i> droite <i>derecha</i> destra	für Erwachsene <i>for adults</i> pour adultes <i>para adultos</i> per adulti	für Kinder <i>for children</i> pour enfants <i>para niños</i> per bambini

Raspatorien – Elevatorien
Periosteal raspatories – Elevators

Rugines – Elevateurs
Raspatorios – Elevadores
 Periostotomi – Elevatori

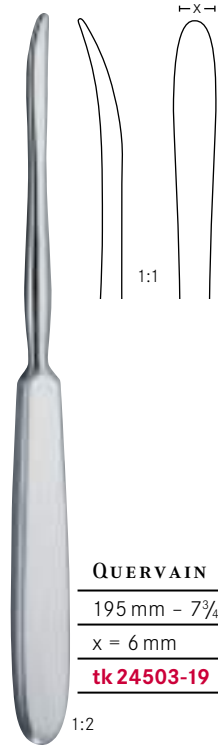

QUERVAIN
 195 mm – 7¾"

 x = 6 mm

tk 24503-19

1:2

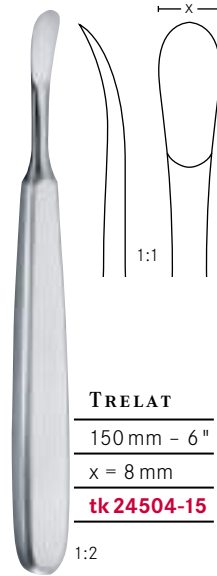

TRELAT
 150 mm – 6"

 x = 8 mm

tk 24504-15

1:2

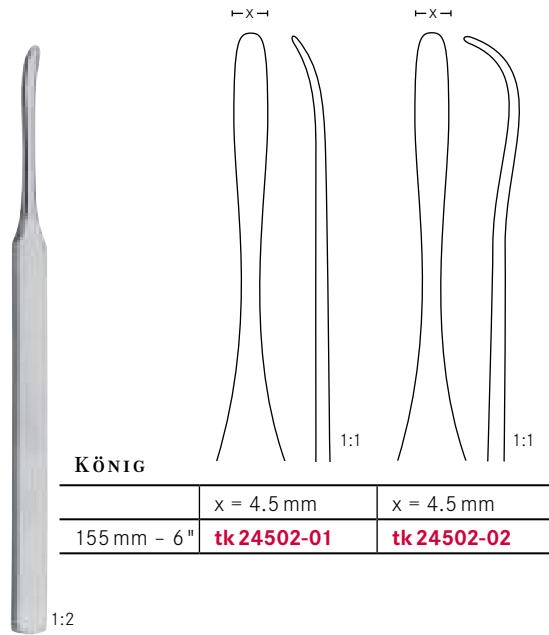

KÖNIG

	x = 4.5 mm	x = 4.5 mm
155 mm – 6" <hr/>	tk 24502-01	tk 24502-02

1:2

Raspatorien - Elevatorien
Periosteal raspatories - Elevators

Rugines - Elevateurs
Raspatorios - Elevadores
Periostotomi - Elevatori

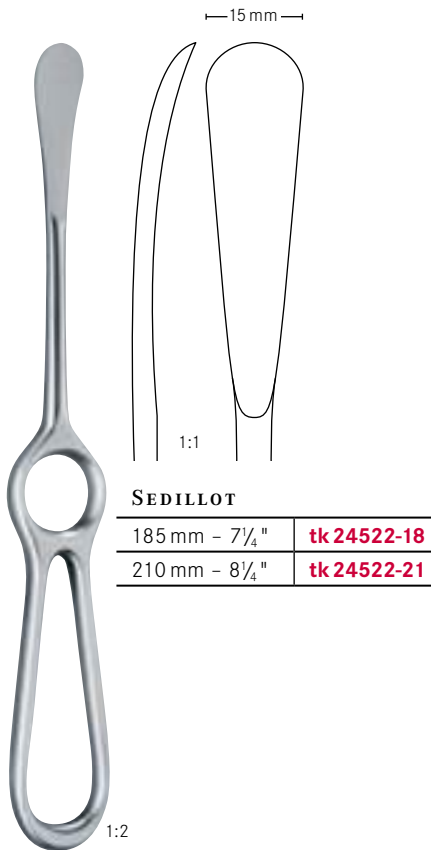
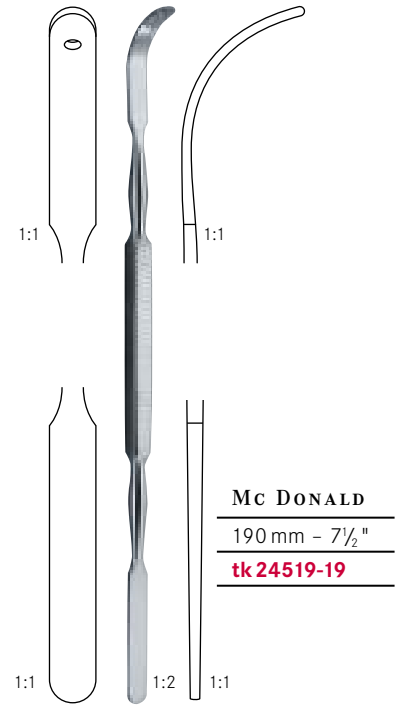
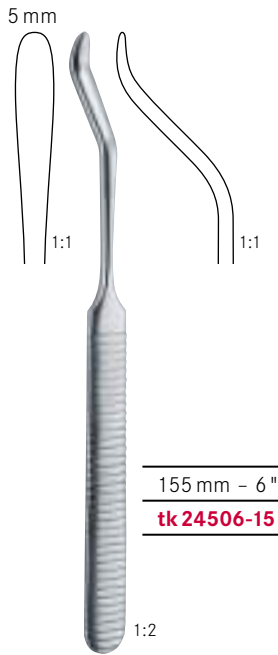

Raspatorien – Elevatorien
 Periosteal raspatories – Elevators

Rugines – Elevateurs
 Raspatorios – Elevadores
 Periostotomi – Elevatori

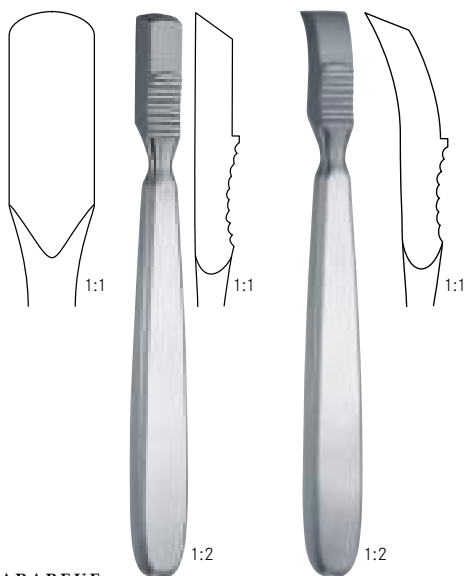

FARABEU
 150 mm – 6" **tk 24520-15** **tk 24521-15**

gerade	gebogen
straight	curved
droit	courbe
recta	curva
retto	curvo

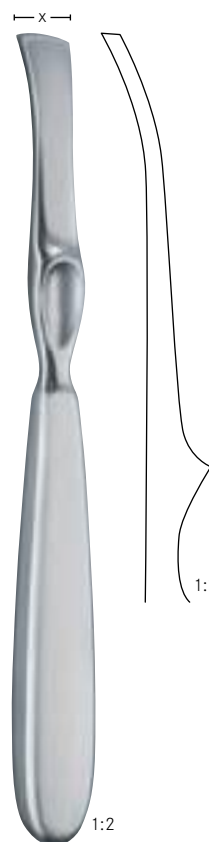

LAMBOTTE
 210 mm – 8 1/4"
 x = 5 mm **tk 24523-05**
 x = 10 mm **tk 24523-10**
 x = 15 mm **tk 24523-15**
 x = 20 mm **tk 24523-20**
 x = 25 mm **tk 24523-25**

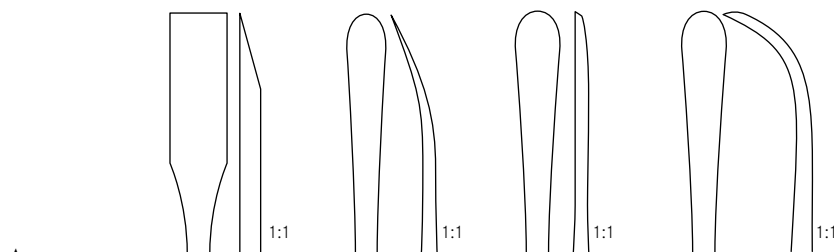

ADSON

	Fig. 1	Fig. 2	Fig. 3	Fig. 4
170 mm – 6 3/4"	tk 24535-01	tk 24535-02	tk 24535-03	tk 24535-04

Raspatorien – Elevatorien
Periosteal raspatories – Elevators

Rugines – Elevateurs
Raspatorios – Elevadores
Periostotomi – Elevatori

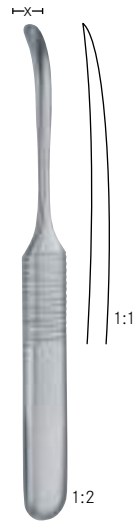

WILLIGER

	x = 5 mm
130 mm – 5"	tk 24525-13

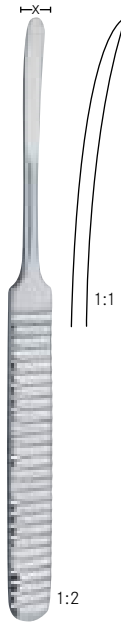

WILLIGER

	160 mm – 6¼"
x = 4 mm	tk 24525-16
x = 6 mm	tk 24526-16

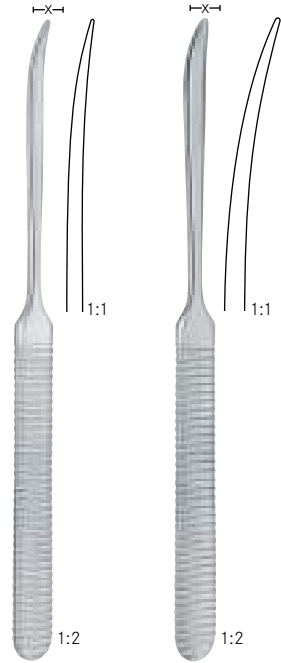

WILLIGER

	x = 5 mm	x = 6.5 mm
160 mm – 6¼"	tk 24532-16	tk 24533-17



**FARABEUF-
COLLIN**

	x = 11 mm	x = 11 mm
160 mm – 6¼"	tk 24528-01	tk 24528-02



Raspatorien – Elevatorien
Periosteal raspatories – Elevators

Rugines – Elevateurs
Raspatorios – Elevadores
 Periostotomi – Elevatori

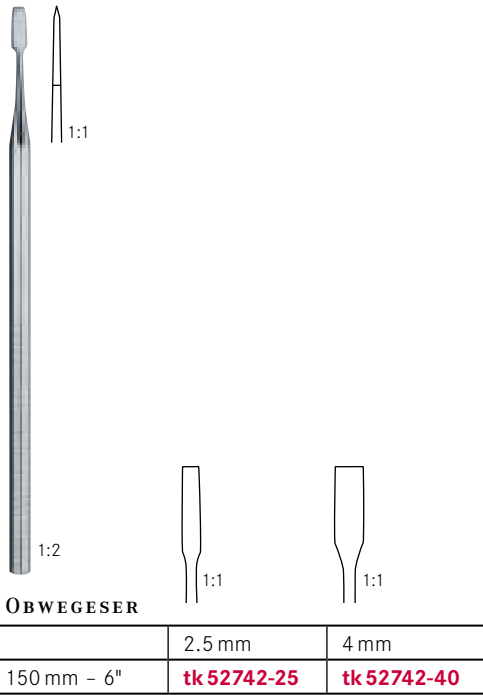

Raspatorien - Elevatorien
Periosteal raspatories - Elevators

Rugines - Elevateurs
Raspatorios - Elevadores
Periostotomi - Elevatori



1:2



1:2



1:2



1:2



1:2



1:2

SEMB

175 mm - 7"	210 mm - 8¼"	175 mm - 7"	210 mm - 8¼"	225 mm - 8¾"	220 mm - 8¾"
12 mm	12 mm	13 mm	13 mm	13 mm	15 mm
tk 24536-01	tk 24536-02	tk 24536-03	tk 24536-04	tk 24536-05	tk 24536-06

Raspatorien - Elevatorien
Periosteal raspatories - Elevators

Rugines - Elevateurs
Raspatorios - Elevadores
 Periostotomi - Elevatori



HOWARTH

215 mm - 8½"

tk 24534-21

scharf / stumpf
sharp / blunt
 pointu / mousse
aguda / roma
 acuta / smussa

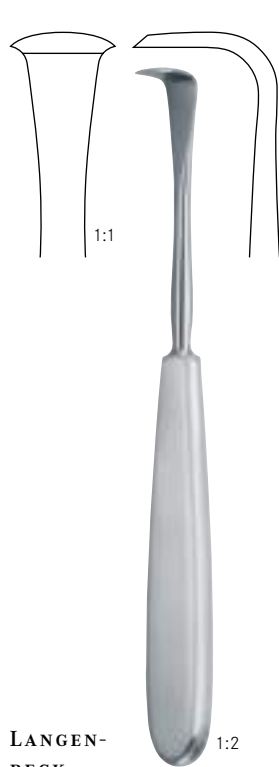

**LANGEN-
BECK**

180 mm - 7"

tk 24537-18

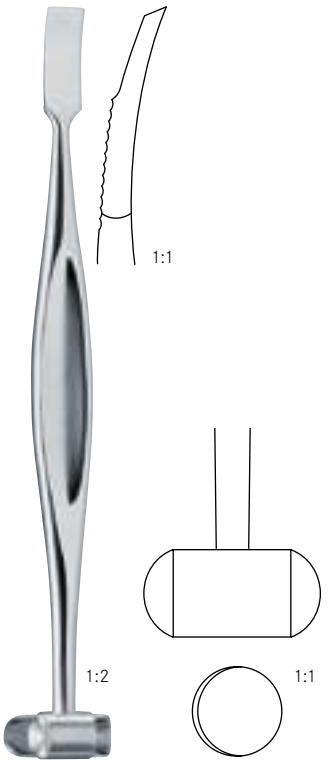

ALEXANDER

200 mm - 8"

tk 24539-20

Raspatorien - Elevatorien
Periosteal raspatories - Elevators

Rugines - Elevateurs
Raspatorios - Elevadores
Periostotomi - Elevatori



LANGENBECK

	x = 8 mm	x = 10 mm
200 mm - 8"	tk 24540-20	tk 24542-20

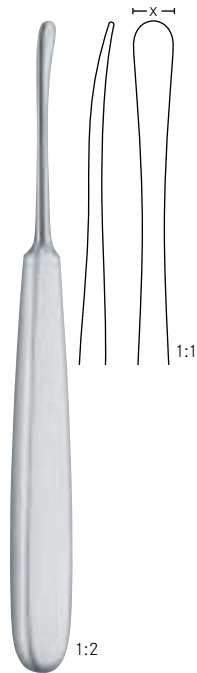

SEBILEAU

	x = 5 mm
175 mm - 7"	tk 24544-17

175 mm - 7"	tk 24546-17
-------------	--------------------

extrem leicht
extremely light
extrêmement léger
extremamente ligero
estremamente leggera

Raspatorien – Elevatorien
Periosteal raspatories – Elevators

Rugines – Elevateurs
Raspatorios – Elevadores
 Periostotomi – Elevatori



1:2

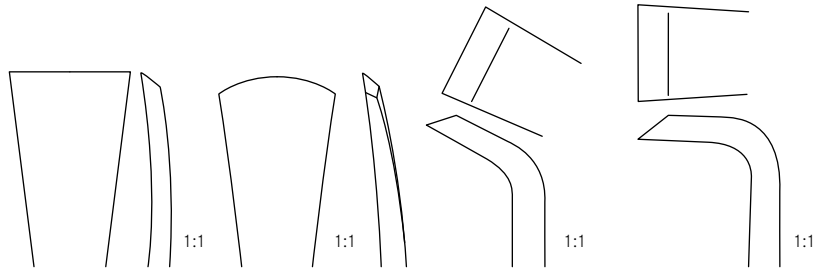

MARTIN-LANGENBECK

190 mm – 7½"	tk 24543-01	tk 24543-02	tk 24543-03	tk 24543-04
--------------	--------------------	--------------------	--------------------	--------------------



1:2

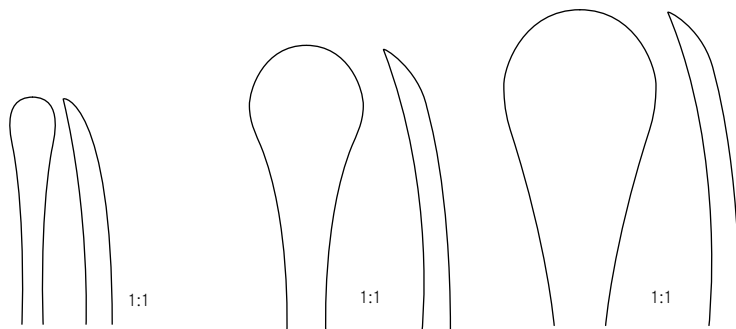

MARTIN-HOEN

160 mm – 6¼"	tk 24514-10		
185 mm – 7¼"		tk 24514-11	
190 mm – 7½"			tk 24514-12

Raspatorien - Elevatorien
Periosteal raspatories - Elevators

Rugines - Elevateurs
Raspatorios - Elevadores
 Periostotomi - Elevatori



1:2

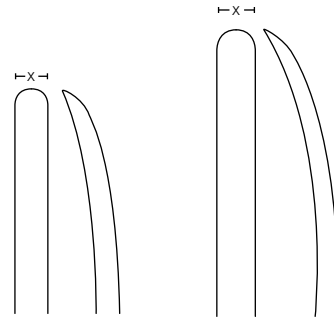

MARTIN-CUSHING

	x = 4 mm	x = 5 mm
175 mm - 7"	tk 24515-04	tk 24515-06

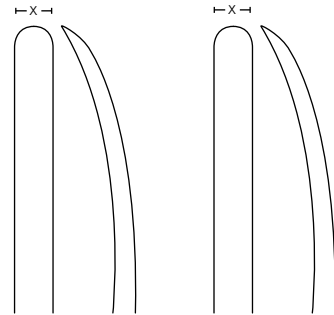

MARTIN-CUSHING

	x = 6 mm	x = 7 mm
195 mm - 7¾"	tk 24515-05	tk 24515-07

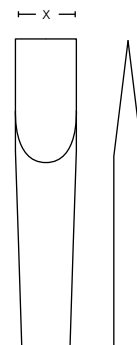

MARTIN-CUSHING

	x = 8 mm
170 mm - 6¾"	tk 24516-08

Raspatorien – Elevatorien
 Periosteal raspatories – Elevators

Rugines – Elevateurs
 Raspatorios – Elevadores
 Periostotomi – Elevatori

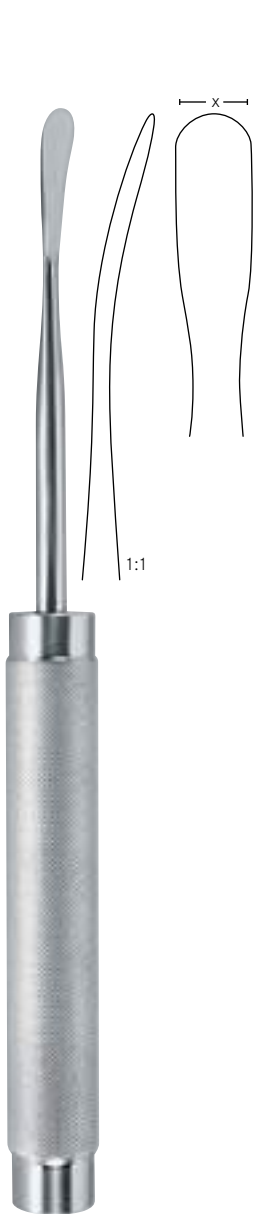

COBB

	280 mm - 11 ^{1/2} "
x = 10 mm	tk 24541-80
x = 13 mm	tk 24541-81
x = 19 mm	tk 24541-82
x = 25 mm	tk 24541-83
x = 32 mm	tk 24541-84

COBB

	290 mm - 11 ^{1/2} "	290 mm - 11 ^{1/2} "
x = 10 mm	tk 24541-10	tk 24541-50
x = 13 mm	tk 24541-13	tk 24541-53
x = 19 mm	tk 24541-19	tk 24541-59
x = 25 mm	tk 24541-25	tk 24541-65
x = 32 mm	tk 24541-32	tk 24541-72
x = 38 mm	tk 24541-38	tk 24541-78

Wirbelsäulen-Raspatorium
 Spinal raspatory

Aluminium Griff
 Aluminium handle

Stahl
 Steel

Rugine vertebral
 Raspatorio vertebral
 Periostotomo vertebrale

manche d'Aluminium
 mango de aluminio
 manico i alluminio

Acier
 Acero
 Acciaio

Raspatorien - Elevatorien
Periosteal raspatories - Elevators

Rugines - Elevateurs
Raspatorios - Elevadores
Periostotomi - Elevatori

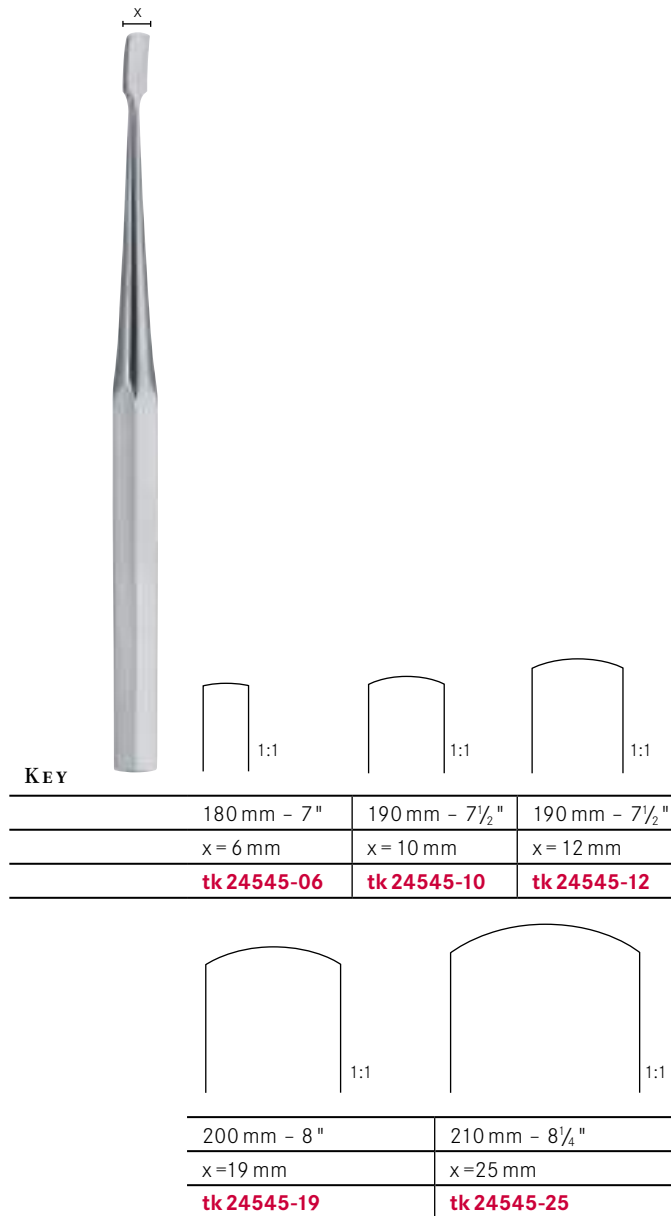

Raspatorien
Periosteal raspatories

Rugines
Raspatorios
 Periostotomi

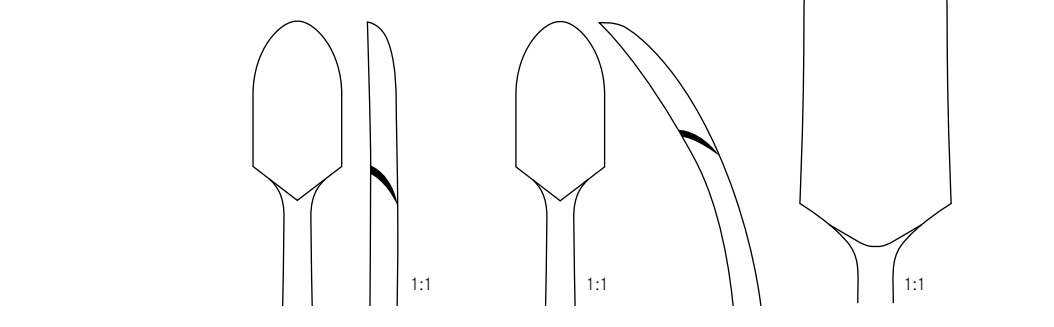

	Fig. 1	Fig. 2	Fig. 3
	14 mm	14 mm	20 mm
200 mm - 8"	tk 24548-01	tk 24548-02	tk 24548-03

Ferrozellgriff	gerade	gebogen	gerade
<i>Ferrozell handle</i>	<i>straight</i>	<i>curved</i>	<i>straight</i>
Manche en Ferrozell	droit	courbe	droit
<i>Mango en Ferrozell</i>	<i>recta</i>	<i>curva</i>	<i>recta</i>
Manico di Ferrozell	rette	curve	rette

1:2

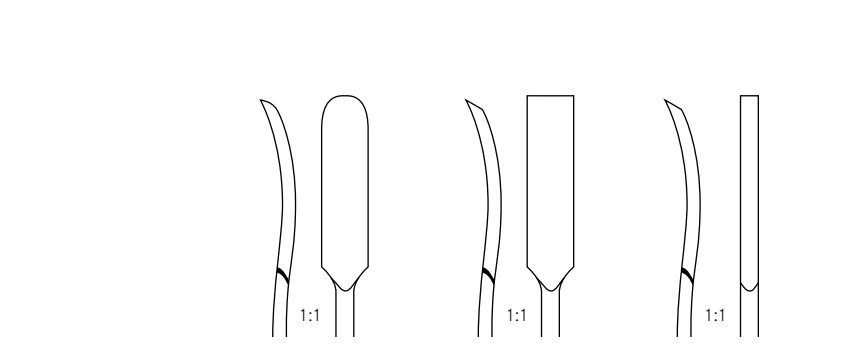

	Fig. 1	Fig. 2	Fig. 3
	6 mm	6 mm	3 mm
180 mm - 7"	tk 24549-01	tk 24549-02	tk 24549-03

Ferrozellgriff
<i>Ferrozell handle</i>
Manche en Ferrozell
<i>Mango en Ferrozell</i>
Manico di Ferrozell

1:2

Knochenhebel
Bone levers

Leviers à os
Elevadores para huesos
Elevatori per ossa



HOHMANN

220 mm - 8¾"	240 mm - 9½"	240 mm - 9½"	240 mm - 9½"
x = 8 mm	x = 18 mm	x = 43 mm	x = 70 mm
tk 24550-08	tk 24550-18	tk 24550-43	tk 24550-70

Knochenhebel
Bone levers

Leviers à os
Elevadores para huesos
Elevatori per ossa



HOHMANN

245 mm - 9 $\frac{3}{4}$ "	260 mm - 10 $\frac{1}{4}$ "	280 mm - 11"	265 mm - 10 $\frac{1}{2}$ "	260 mm - 10 $\frac{1}{4}$ "
x = 43 mm	x = 22 mm	x = 33 mm	x = 24 mm	x = 22 mm
tk 24558-43	tk 24558-22	tk 24558-33	tk 24559-24	tk 24561-22

Knochenhebel
Bone levers

Leviers à os
Elevadores para huesos
Elevatori per ossa



1:2

MINI-HOHMANN

	6 mm	8 mm
160 mm - 6 1/4"	tk 24551-06	tk 24551-08



1:1



1:1



1:2

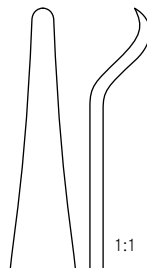

1:1

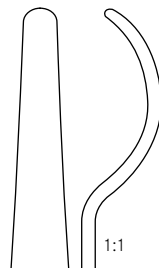

1:1

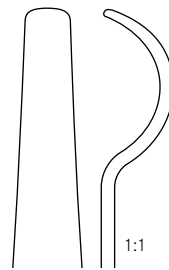

1:1

	2.8 mm	4.5 mm	6 mm
140 mm - 5 1/2"	tk 24552-02	tk 24552-04	tk 24552-06



1:2

BRISTOW

230 mm - 9"	tk 24552-23
-------------	--------------------



1:2

LANE

210 mm - 8 1/4"	tk 24552-21
-----------------	--------------------

Knochenhebel
Bone levers

Leviers à os
Elevadores para huesos
Elevatori per ossa



	x = 15 mm
150 mm - 6"	tk 24553-15



	x = 16 mm
160 mm - 6 1/4"	tk 24554-16



	x = 15 mm
160 mm - 6 1/4"	tk 24554-17



SHOULDER

32 x 81 mm	tk 24554-50
38 x 81 mm	tk 24554-51



FUKUDA

x = 32 mm	tk 24554-52
x = 40 mm	tk 24554-53



FUKUDA

x = 35 mm	tk 24554-54
-----------	--------------------

Knochenhebel
Bone levers

Leviers à os
Elevadores para huesos
Elevatori per ossa

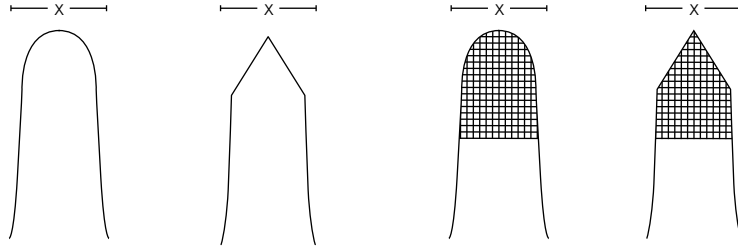

COBRA

	x = 32 mm	x = 32 mm	x = 32 mm	x = 32 mm
260 mm - 10¼"	tk 24557-01	tk 24557-02	tk 24557-03	tk 24557-04

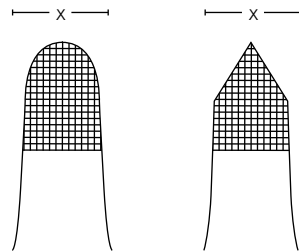

COBRA

	x = 44 mm	x = 44 mm
266 mm - 10½"	tk 24557-05	tk 24557-06

CHANDLER

	180 mm - 7"	200 mm - 8"	230 mm - 9"	250 mm - 9¾"
x = 13 mm	tk 24577-13			
x = 19 mm		tk 24577-19		
x = 25 mm			tk 24577-25	
x = 32 mm				tk 24577-32



Knochenhebel
Bone levers

Leviers à os
Elevadores para huesos
Elevatori per ossa



BENNETT	
	240 mm - 9 1/2"
x = 43 mm	tk 24555-01
x = 60 mm	tk 24555-02

1:2



MURPHY-LANE	
	300 mm - 12"
	tk 24556-34

Luxationshebel
Luxation lever
Levier de luxation
Palanca de luxación
Leva per luxazione

1:2

Knochenhebel
Bone levers

Leviers à os
Elevadores para huesos
Elevatori per ossa



BLOUNT

	260 mm - 10 $\frac{1}{4}$ "	260 mm - 10 $\frac{1}{4}$ "
	x = 38 mm	x = 42 mm
	tk 24562-26	tk 24563-26



**LANGE-
HOHMANN MOD.**

	265 mm - 10 $\frac{1}{2}$ "	280 mm - 11"
	x = 30 mm	x = 33 mm
	tk 24561-26	tk 24561-28

Knochenhebel
Bone levers

Leviers à os
Elevadores para huesos
Elevatori per ossa

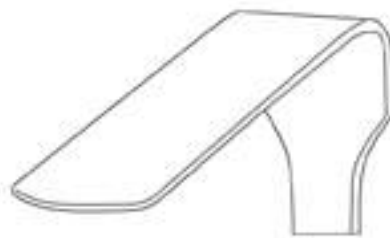

SMILIE

x	y		
19 mm	32 mm	tk 24574-01	
19 mm	45 mm		tk 24574-02

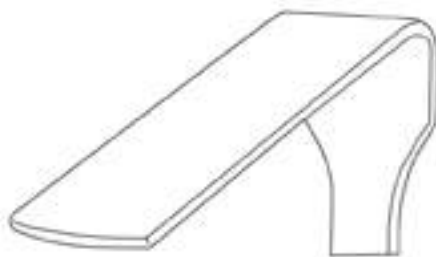

SMILIE

x	y		
19 mm	60 mm	tk 24574-03	
13 mm	15 mm		tk 24574-04



SMILIE

x	y		
13 mm	55 mm	tk 24574-05	

Knochenhebel
Bone levers

Leviers à os
Elevadores para huesos
Elevatori per ossa

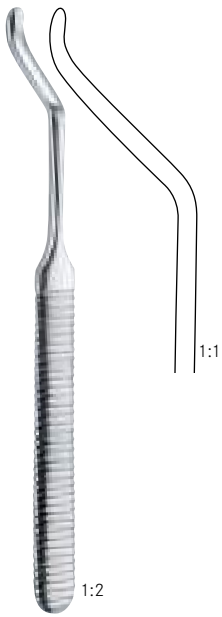

**HOHMANN-
WILLIGER**

160 mm - 6¼"

tk 24560-16

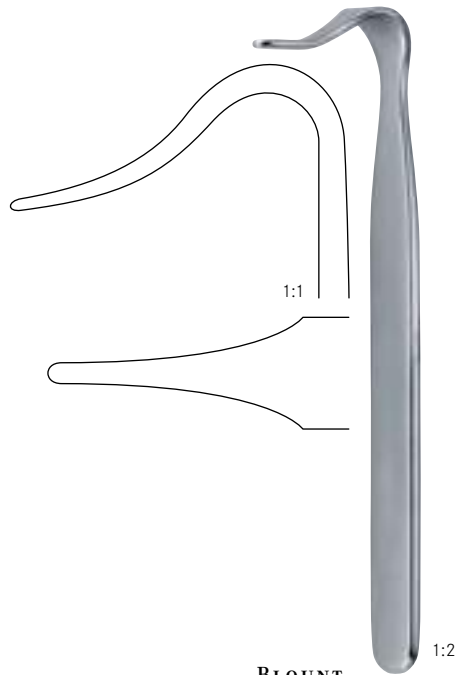

BLOUNT

175 mm - 7"

tk 24564-17



TAYLOR

165 mm - 6½"

a = 75 mm - b = 30 mm

tk 24566-16

a = 100 mm - b = 30 mm

tk 24567-16

Meniskotome
Meniscotomy knives

Bistouries à ménisques
Bisturías para meniscos
Bisturi per menisco



BIRCHER

190 mm - 7½" **tk 24563-19**

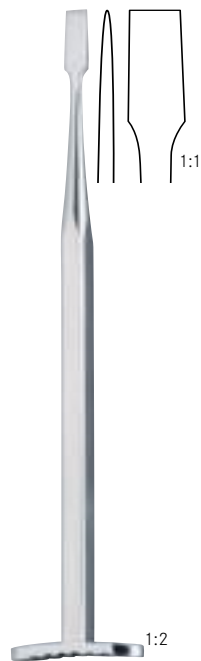

SMILLIE

170 mm - 6¾" **tk 24568-17**



tk 24569-17



tk 24570-17

Sehnenstripper
Tendon strippers

Instruments à écorcher les tendons
Enucleadores de tendones
Scollatendini



	○ 1:1	○ 1:1	○ 1:1
	4.0 mm Ø	4.5 mm Ø	5.5 mm Ø
230 mm - 9"	tk 24578-40	tk 24578-45	tk 24578-55

Schaft biegsam
Malleable shaft
Tige malléable
Tija maleable
Asta malleabile

1:2



BUNNELL	○ 1:1	○ 1:1	○ 1:1
	Fig. 1	Fig. 2	Fig. 3
150 mm - 6"	tk 24575-01	tk 24575-02	tk 24575-03

○ 1:1	○ 1:1
Fig. 4	Fig. 5
tk 24575-04	tk 24575-05

1:2

Sehnenstripper
Tendon strippers

Instruments à écorcher les tendons
Enucleadores de tendones
Scollatendini



FISCHER
310 mm - 12 1/4"
tk 24580-31



BUNNELL
230 mm - 9"
tk 24582-23

Sehnen durchzugs sonde
Tendon passer

Sonde conductrice pour tendons
Sonda conductora de tendones
Sonda conduttrice per tendini





**KLEINERT-
KUTZ**
200 mm - 8"
20 mm Ø
tk 24588-20



Sehnenfazzangen
Tendon holding forceps

Pinces pour saisir les tendons
Pinzas para coger tendones
Pinze per afferrare tendini





	 1:1	 1:1	 1:1
BRAND	150 mm - 6"	190 mm - 7½"	240 mm - 9½"
	tk 24585-15	tk 24585-19	tk 24585-24

gerade
straight
dróite
recta
retta

	 1:1	 1:1
BRAND	150 mm - 6"	185 mm - 7¼"
	tk 24586-15	tk 24586-18

gebogen
curved
courbe
curva
curva

	 1:1	 1:1	 1:1
BRAND	150 mm - 6"	190 mm - 7½"	240 mm - 9½"
	tk 24585-04	tk 24585-05	tk 24585-06

gerade, mit Sperre
straight, with ratchet
dróite, avec crémaillère
recta, con cierre
retta, con cremagliera

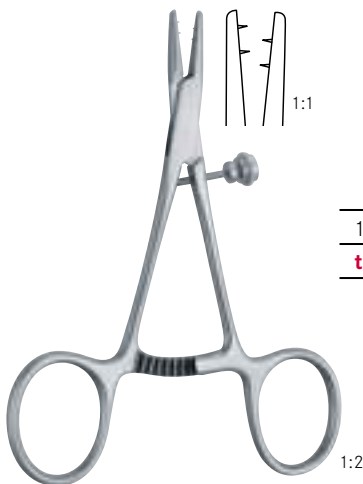

130 mm - 5"
tk 38724-13

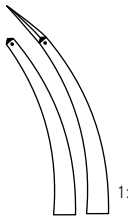

	 1:1	 1:1
150 mm - 6"	tk 24589-15	tk 24590-15

Hohlmeißelzangen | Pincés gougés
Bone rongeurs | Pinzas gubias
 Pinze sgorbie

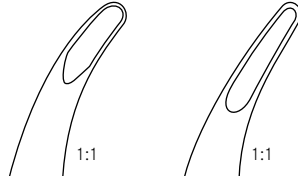

LUER	Fig. 1	Fig. 2
150 mm - 6"	tk 24601-15	tk 24602-15

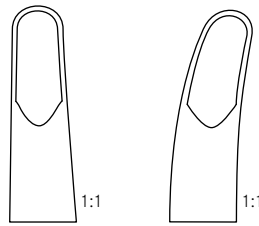

LUER	Fig. 1	Fig. 2
170 mm - 6¾"	tk 24603-17	tk 24604-17



MINI-FRIEDMANN
120 mm - 4¾"
tk 24605-12

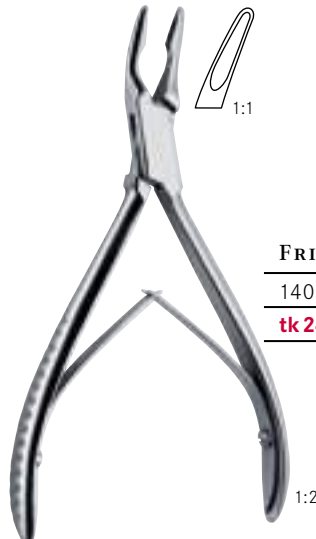

FRIEDMANN
140 mm - 5½"
tk 24605-14

Hohlmeißelzangen
Bone rongeurs

Pinces gouges
Pinzas gubias
Pinze sgorbie



BLUMENTHAL

	Fig. 1	Fig. 2	Fig. 3
155 mm - 6"	tk 24606-01	tk 24606-02	tk 24606-03

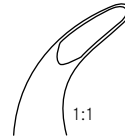

JANSEN

	Fig. 1	Fig. 2
180 mm - 7"	tk 24607-01	tk 24607-02

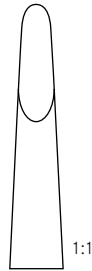

Hohlmeißelzangen
Bone rongeurs

Pinces gouges
Pinzas gubias
Pinze sgorbie



JANSEN

190 mm - 7½"

tk 24608-19



ADSON

200 mm - 8"

tk 24609-20



BACON

210 mm - 8¼"

tk 24610-21

Hohlmeißelzangen
Bone rongeurs

Pinces gouges
Pinzas gubias
Pinze sgorbie



LEMPERT

190 mm - 7½"

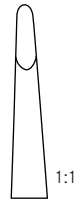

1:1

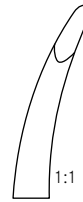

1:1

tk24612-19

tk24611-19

1:2



STELBRINK

175 mm - 7"



1:1

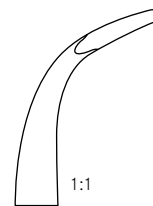

1:1

tk24614-01

tk24614-02

leicht gebogen

slightly curved

légèrement courbe

ligeramente curvada

legermente curvata

stark gebogen

strongly curved

très courbe

fuertemente curvada

fortemente curvata

1:2

Hohlmeißelzangen
Bone rongeurs

Pinces gouges
Pinzas gubias
Pinze sgorbie

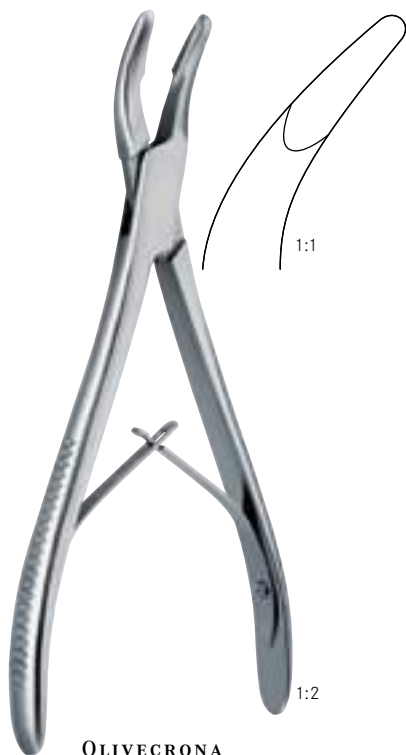

OLIVECRONA

205 mm - 8"

tk 24620-20

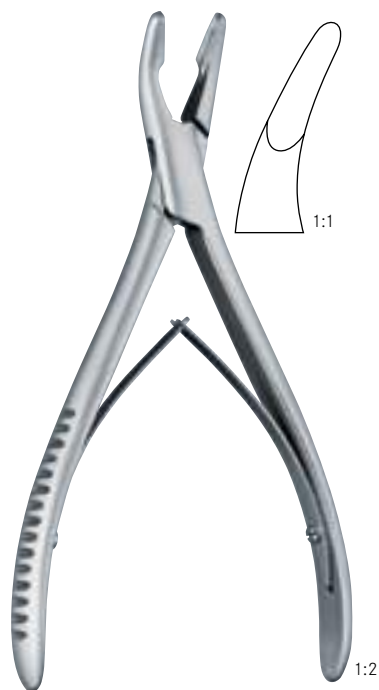

HARTMANN

175 mm - 7"

tk 24622-18

Hohlmeißelzangen
Bone rongeurs

Pinces gouges
Pinzas gubias
Pinze sgorbie



MEAD

165 mm - 6½"

tk 24631-16



CLEVELAND

170 mm - 6¾"

tk 24637-17



CLEVELAND

140 mm - 5½"

tk 24635-14

Hohlmeißelzangen
Bone rongeurs

Pinces gouges
Pinzas gubias
Pinze sgorbie

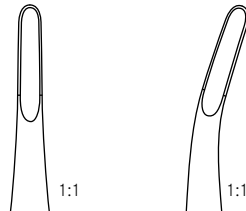

BÖHLER

150 mm - 6"

tk 24613-00

tk 24613-02

1:2

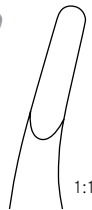

ZAUFAL-JANSEN

180 mm - 7"

tk 24614-18

1:2



MARQUARDT

200 mm - 8"

tk 24614-20

1:2

Hohlmeißelzangen
Bone rongeurs

Pinces gouges
Pinzas gubias
Pinze sgorbie



1:1

BEYER

180 mm - 7"

tk 24615-18

1:2

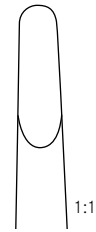

1:1

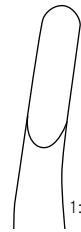

1:1

RUSKIN

180 mm - 7"

tk 24616-05

tk 24616-04

1:2



1:1

MAYFIELD

175 mm - 7"

tk 24627-17

1:2

Hohlmeißelzangen | Pincés gougés
 Bone rongeurs | Pinzas gubias
 Pinze sgorbie

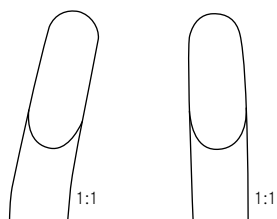

**STILLE-
RUSKIN**

230 mm - 9"	tk 24617-23	tk 24618-23
-------------	--------------------	--------------------

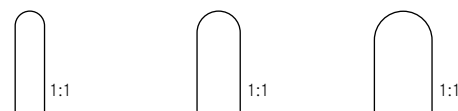

STILLE





	4 mm	6 mm	8 mm
230 mm - 9"	tk 24619-04	tk 24619-06	tk 24619-08



Hohlmeißelzangen
Bone rongeurs

Pinces gouges
Pinzas gubias
Pinze sgorbie



1:2

LEKSELL	 1:1	 1:1	 1:1	 1:1
	2 mm	3 mm	4 mm	5 mm
240 mm - 9½"	tk 24621-02	tk 24621-13	tk 24621-04	tk 24621-15

 1:1	 1:1
6 mm	8 mm
tk 24621-06	tk 24621-08

Hohlmeißelzangen
Bone rongeurs

Pinces gouges
Pinzas gubias
Pinze sgorbie

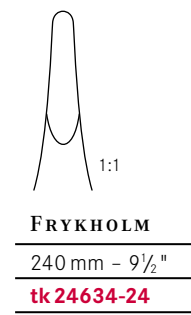
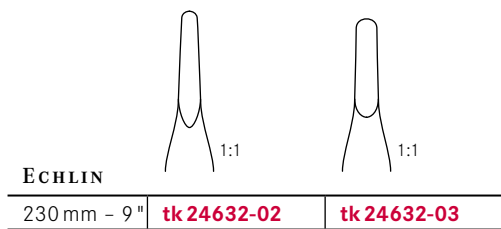

Hohlmeißelzangen
Bone rongeurs

Pinces gouges
Pinzas gubias
Pinze sgorbie

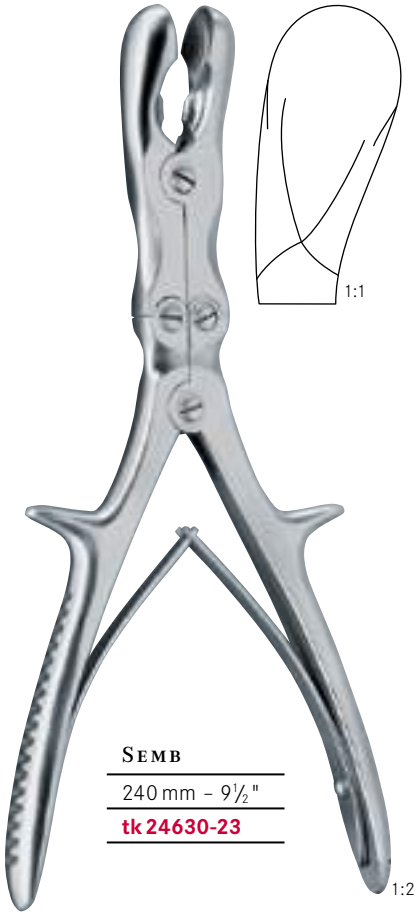

Hohlmeißelzangen
Bone rongeurs
 Pincas gougas
Pinzas gubias
 Pinze sgorbie

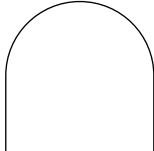

SAUERBRUCH	 1:1	 1:1
	Fig. 1	Fig. 2
300 mm - 12"	tk 24633-01	tk 24633-02

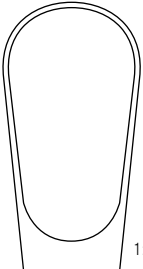
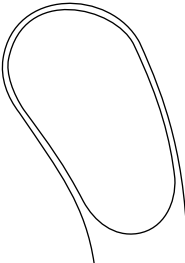

LUER-STILLE	 1:1	 1:1
	270 mm - 10 ³ / ₄ "	tk 24646-27

Knochensplitterzangen
Bone cutting forceps

Pincés coupantes à os
Pinzas cortantes para huesos
Cesoie per ossa



**COTTLE-
KAZANJIAN**

190 mm - 7½"

tk 24649-19

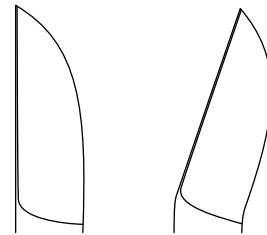

LISTON

140 mm - 5½"	tk 24650-14	tk 24651-14
170 mm - 6¾"	tk 24650-17	tk 24651-17
190 mm - 7½"	tk 24650-19	tk 24651-19
220 mm - 8¾"	tk 24650-22	tk 24651-22

Knochensplitterzangen
Bone cutting forceps

Pinces coupantes à os
Pinzas cortantes para huesos
Cesoie per ossa



BÖHLER

150 mm - 6"

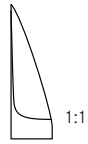

1:1



1:1

tk 24654-15

tk 24655-15

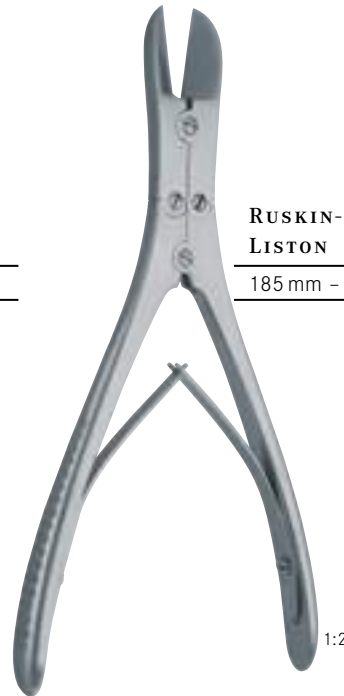

**RUSKIN-
LISTON**

185 mm - 7 1/4"



1:1

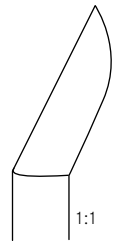

1:1

tk 24660-18

tk 24661-18



**STILLE-
LISTON**

270 mm - 10 3/4"

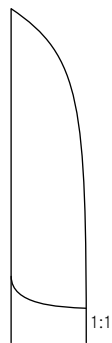

1:1

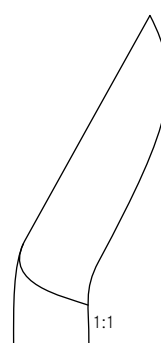

1:1

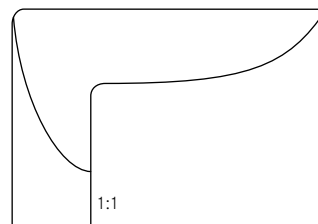

1:1

tk 24670-27

tk 24671-27

tk 24673-27

Knochensplitterzangen
Bone cutting forceps

Pincés coupantes à os
Pinzas cortantes para huesos
Cesoie per ossa



SEM B

240 mm - 9½"

tk 24677-24



LISTON-KEY HORSLEY

270 mm - 10¾"

tk 24675-27

Knochenhalteklammern – Knochenhaltezangen
 Bone holding clamps – Bone holding forceps

Daviers à os – Daviers porte-os
 Pinzas porta huesos – Pinzas para huesos
 Tenaglie per ossa



GERSTER-LOWMANN

180 mm - 7"	x = 28 mm	tk 24696-18
200 mm - 8"	x = 35 mm	tk 24696-20
220 mm - 8¾"	x = 40 mm	tk 24696-22

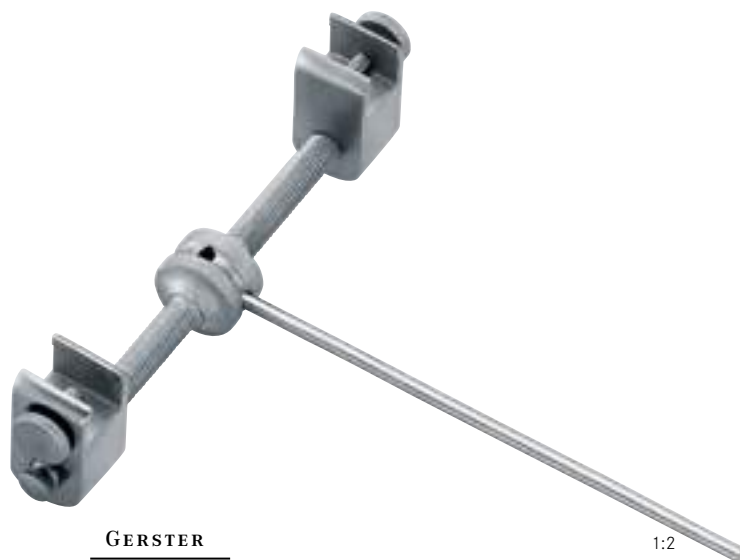

GERSTER

150 mm - 6"	tk 24698-00
-------------	--------------------

Knochenhaltezangen - Repositionszangen
Bone holding forceps - Reposition forceps

Daviers porte-os - Pincas de reposition
Pinzas para huesos - Pinzas para reposición
Tenaglie per ossa - Pinze per riposizioni



135 mm - 5 1/4"
tk 24740-14



LEWIN
175 mm - 7"
tk 24726-17



140 mm - 5 1/2"
tk 24735-14

Knochenhalteklammern – Knochenhaltezangen
Bone holding clamps – Bone holding forceps

Daviers à os – Daviers porte-os
Pinzas porta huesos – Pinzas para huesos
Tenaglie per ossa

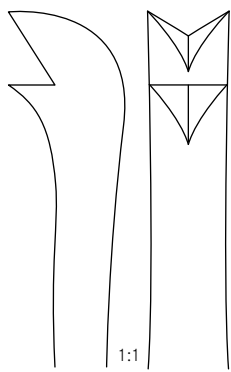

FERGUSSON

210 mm - 8 1/4"

tk 24700-21

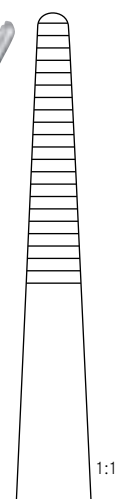

VAN BUREN

230 mm - 9"

tk 24701-23

Knochenhaltezangen
Bone holding forceps

Daviers porte-os
Pinzas para huesos
Tenaglie per ossa



LANGENBECK

210 mm - 8 $\frac{1}{4}$ "

tk 24702-21



SEMB

190 mm - 7 $\frac{1}{2}$ "

tk 24704-19

Knochenhaltezangen
Bone holding forceps

Daviers porte-os
Pinzas para huesos
Tenaglie per ossa

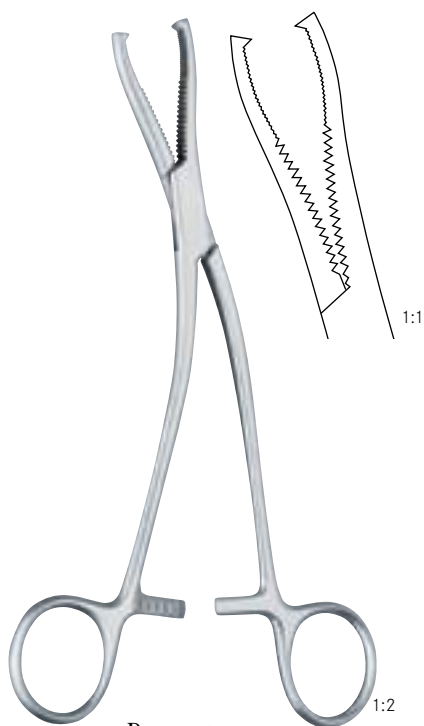

DINGMANN

190 mm - 7½"

tk 24705-19



200 mm - 8"

tk 24706-20

tk 24707-20

Sequesterzange

Sequestrum forceps

Pince pour Sequestrum

Pinza para Sequestrum

Pinza per Sequestrum

Knochenhalte­zangen
Bone holding forceps

Daviers porte-os
Pinzas para huesos
Tenaglie per ossa

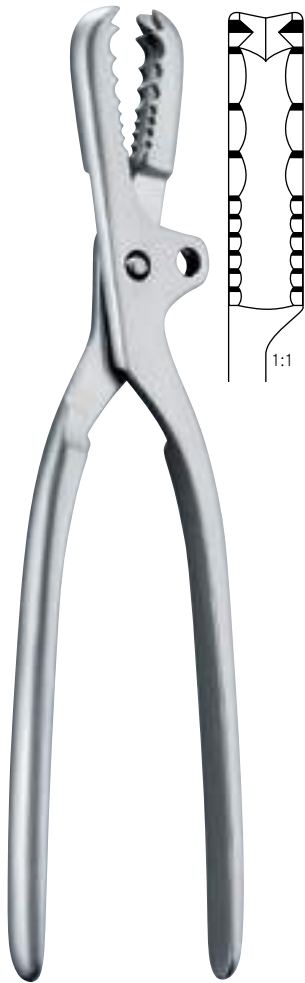

FARABEU

230 mm - 9"	tk 24709-23
260 mm - 10¼"	tk 24709-26



FARABEU-LAMBOTTE

260 mm - 10¼"	tk 24710-26
---------------	--------------------

Knochenhaltezangen
Bone holding forceps

Daviers porte-os
Pinzas para huesos
Tenaglie per ossa



1:1

MARTIN

190 mm - 7½"

tk 24712-19

1:2



1:1

**BIRCHER-
GANSKE**

200 mm - 8"



1:1

tk 24713-20



1:1

tk 24714-20

1:2

Knochenhaltezangen
Bone holding forceps

Daviers porte-os
Pinzas para huesos
Tenaglie per ossa



HEY GROVES

210 mm - 8¼"	x = 6.5 mm	tk 24724-21
270 mm - 10¾"	x = 7.5 mm	tk 24724-27
305 mm - 12"	x = 8.5 mm	tk 24724-30

Knochenhaltezangen
Bone holding forceps

Daviers porte-os
Pinzas para huesos
Tenaglie per ossa

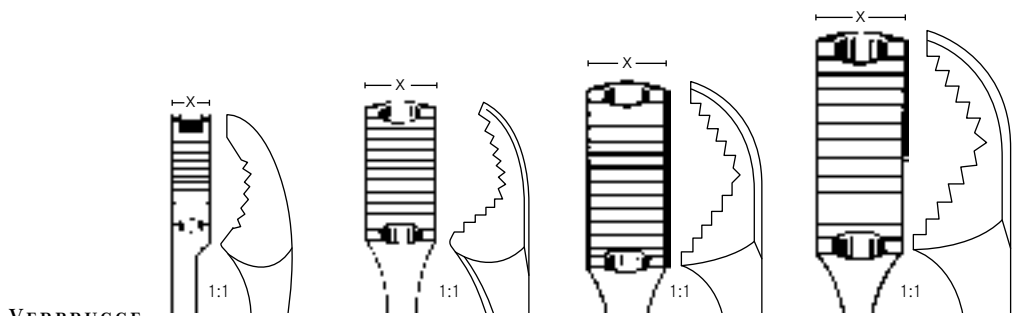

VERBRUGGE			
175 mm - 7"	250 mm - 10"	260 mm - 10¼"	270 mm - 10¾"
x = 5.0 mm	x = 9.5 mm	x = 10.5 mm	x = 12.0 mm
tk 24730-17	tk 24730-25	tk 24730-26	tk 24730-27

Knochenhaltezangen
Bone holding forceps

Daviers porte-os
Pinzas para huesos
Tenaglie per ossa



KERN

170 mm - 6 $\frac{3}{4}$ "	tk 24720-17	tk 24721-17
210 mm - 8 $\frac{1}{4}$ "	tk 24720-21	tk 24721-21

Knochenhaltezangen
Bone holding forceps

Daviers porte-os
Pinzas para huesos
Tenaglie per ossa



LANE

330 mm - 13"	tk 24722-33	tk 24723-33
450 mm - 17 ³ / ₄ "	tk 24722-45	tk 24723-45

Knochenhaltezangen
Bone holding forceps

Daviers porte-os
Pinzas para huesos
Tenaglie per ossa

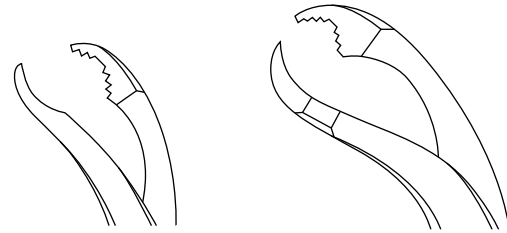

150 mm - 6 "	x = 2.5 mm	tk 24733-15	
190 mm - 7½ "	x = 6.5 mm		tk 24733-00

selbstzentrierend
self-centering
auto-centreur
autocentrante
autocentrante

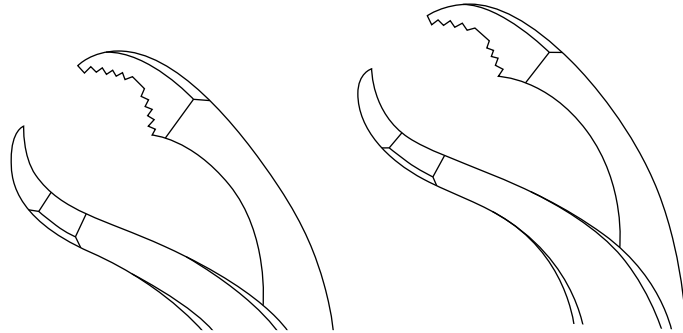

240 mm - 9½ "	x = 9.5 mm	tk 24733-01	
260 mm - 10¼ "	x = 10.0 mm		tk 24733-02

selbstzentrierend
self-centering
auto-centreur
autocentrante
autocentrante

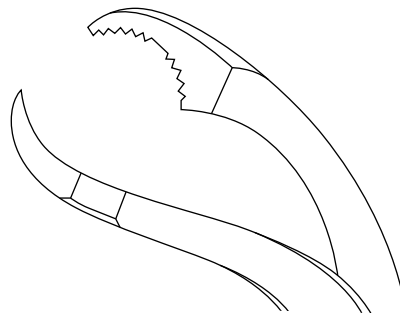

280 mm - 11 "	x = 11.0 mm	tk 24733-03	
---------------	-------------	--------------------	--

selbstzentrierend
self-centering
auto-centreur
autocentrante
autocentrante



Knochenhaltezangen
Bone holding forceps

Daviers porte-os
Pinzas para huesos
Tenaglie per ossa

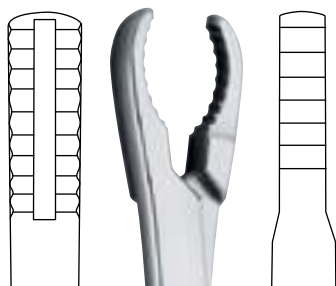

ULRICH

230 mm - 9"	tk 24736-23	tk 24737-23
250 mm - 9¾"	tk 24736-25	tk 24737-25
280 mm - 11"	tk 24736-28	tk 24737-28

kniegebogen
angular
coudée
acodada
angolata

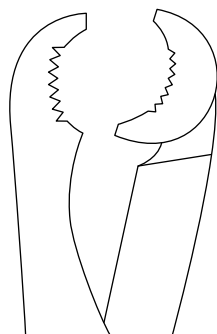

LAMBOTTE

220 mm - 8¾"	tk 24732-22
270 mm - 10¾"	tk 24732-27
300 mm - 12"	tk 24732-30

ein Maulteil beweglich
one jaw mobile

un mors mobile
una boca mobile
una parte del morso mobile

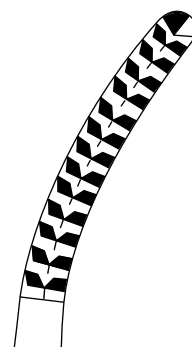

160 mm - 6¼"	tk 24738-16
240 mm - 9½"	tk 24738-24

Knochenhaltezangen – Repositionszangen
Bone holding forceps – Reposition forceps

Daviers porte-os – Pincas de reposition
Pinzas para huesos – Pinzas para reposición
Tenaglie per ossa – Pinze per riposizione

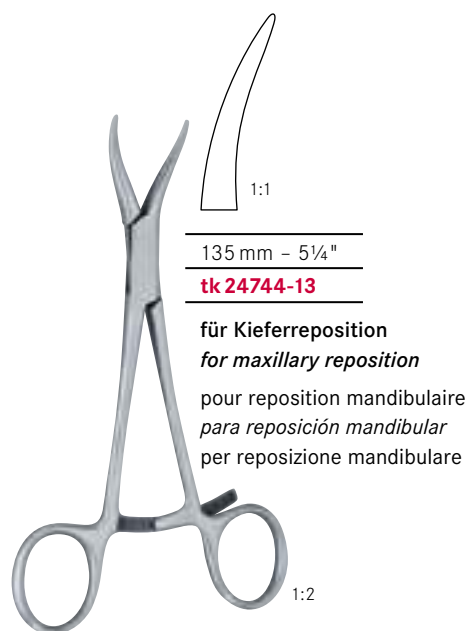
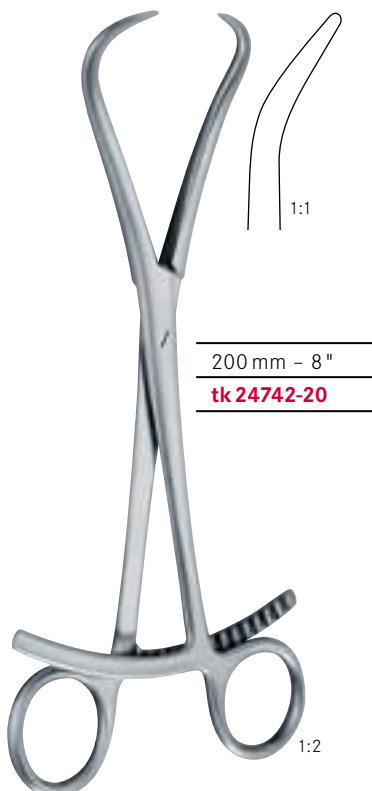

Repositionszangen
Reposition forceps

Pinces de reposition
Pinzas para reposición
Pinze per riposizione

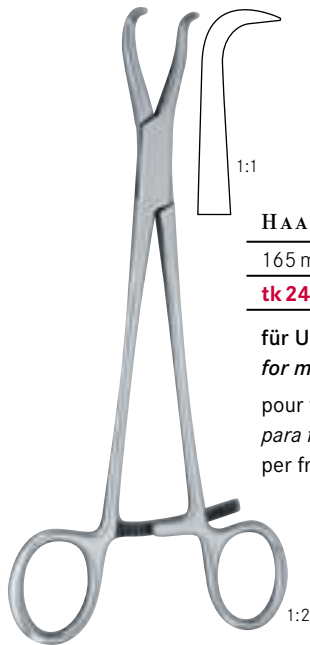

HAASE

165 mm - 6½"

tk 24745-16

für Unterkieferfrakturen
for mandibular fractures
pour fractures mandibulaires
para fracturas del mandibulo
per fratture mandibulare

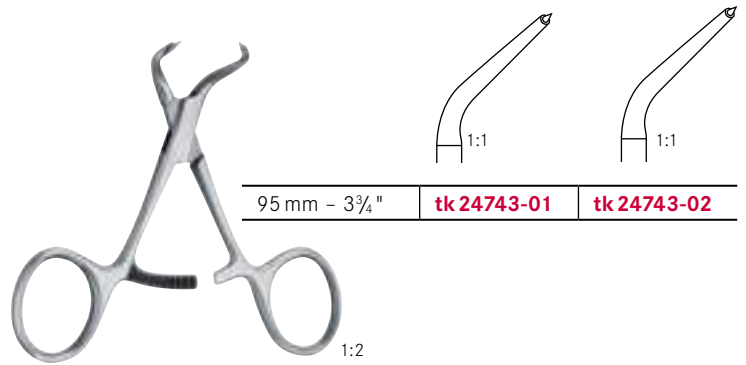

95 mm - 3¾"

tk 24743-01

tk 24743-02



185 mm - 7¼"

tk 24748-18

Patellazange
Patella forceps
Pince pour la rotule
Pinza para la rótula
Pinza per rotula



210 mm - 8¼"

tk 24749-21

Knöchelfasszange
Malleolar forceps
Pince pour le malléole
Pinza para el maleolo
Pinza per malleolo

Draht-Instrumentarium
Wire instruments

Instruments pour cerclage
Instrumental para cerclaje
Strumenti per filo di cerchiaggio



DEMEL	
	280 mm - 11 "
x = 32 mm	tk 38517-01
x = 45 mm	tk 38517-02
x = 62 mm	tk 38517-03



DEMEL	
	280 mm - 11 "
	tk 38518-28

Draht-Instrumentarium
Wire instruments

Instruments pour cerclage
Instrumental para cerclaje
Strumenti per filo di cerchiaggio



LOUTE

210 mm - 8 1/4"

tk 38520-21

1:2



130 mm - 5"

tk 38532-13

1:2



0.2 mm Ø	tk 38550-02
0.3 mm Ø	tk 38550-03
0.4 mm Ø	tk 38550-04
0.5 mm Ø	tk 38550-05
0.6 mm Ø	tk 38550-06
0.7 mm Ø	tk 38550-07
0.8 mm Ø	tk 38550-08
0.9 mm Ø	tk 38550-09
1.0 mm Ø	tk 38550-10
1.2 mm Ø	tk 38550-12
1.5 mm Ø	tk 38550-15

Knochendraht, weich, in Ringen à 10 m
Bone wire, soft, in coils of 10 m

Fil de cerclage, souple, de 10 m
Alambre de cerclaje, blando, de 10 m
Filo per ossa, morbida, anelli da 10 m



0.8 mm Ø x 280 mm	tk 38552-08
1.0 mm Ø x 280 mm	tk 38552-10
1.2 mm Ø x 280 mm	tk 38552-12
1.0 mm Ø x 600 mm	tk 38553-10
1.2 mm Ø x 600 mm	tk 38553-12

Knochendraht mit Auge, weich, Packung à 10 Stück
Bone wire with eye, soft, package of 10 pieces

Fil de cerclage, souple, paquet de 10 pièces
Alambre de cerclaje, blando, paquete de 10 piezas
Filo per ossa con ansa, morbida, pacchetto di 10 pezzi

Drahtschneidezangen
Wire cutting forceps

Pinces coupantes
Alicates para cortar alambre
Pinze taglia filo

TUCARTK



220 mm - 8 $\frac{3}{4}$ "

tk 38561-22 tucart

für harte Drähte bis 2.5 mm Ø
for hard wires up to 2.5 mm Ø
pour fils durs à diam. 2.5 mm Ø
para alambres duros hasta 2.5 mm Ø
per fili duri fina 2.5 mm Ø



220 mm - 8 $\frac{3}{4}$ "

tk 38554-22 tucart

für harte Drähte bis 2.2 mm Ø
for hard wires up to 2.2 mm Ø
pour fils durs à 2.2 mm Ø
para alambres duros hasta 2.2 mm Ø
per fili duri fina 2.2 mm Ø



230 mm - 9"

tk 38554-23 tucart

für harte Drähte bis 2.2 mm Ø
for hard wires up to 2.2 mm Ø
pour fils durs à 2.2 mm Ø
para alambres duros hasta 2.2 mm Ø
per fili duri fina 2.2 mm Ø

Drahtschneidezangen
Wire cutting forceps

Pinces coupantes
Alicates para cortar alambre
Pinze taglia filo



1:2

180 mm - 7"

tk38555-18 tucar

für harte Drähte bis 1.5 mm Ø
for hard wires up to 1.5 mm Ø
pour fils durs à 1.5 mm Ø
para alambres duros hasta 1.5 mm Ø
per fili duri fina 1.5 mm Ø



1:2

180 mm - 7"

tk 38557-18 tucar

für harte Drähte bis 1.5 mm Ø
for hard wires up to 1.5 mm Ø
pour fils durs à 1.5 mm Ø
para alambres duros hasta 1.5 mm Ø
per fili fina 1.5 mm Ø



1:2

150 mm - 6"

tk38556-15 tucar

für harte Drähte bis 1 mm Ø
for hard wires up to 1 mm Ø
pour fils durs à 1 mm Ø
para alambres duros hasta 1 mm Ø
per fili duri fina 1 mm Ø



1:2

145 mm - 5¾"

tk38561-14 tucar

für harte Drähte bis 1 mm Ø
for hard wires up to 1 mm Ø
pour fils durs à 1 mm Ø
para alambres duros hasta 1 mm Ø
per fili duri fino a 1 mm Ø

Drahtschneidezangen
Wire cutting forceps

Pinces coupantes
Alicates para cortar alambre
Pinze taglia filo



570 mm - 22½" | **tk 38558-57**

für Kirschner Drähte und Steinmann Nägel bis 6 mm Ø
for Kirschner wires and Steinmann pins up to 6 mm Ø

pour des broches Kirschner et clous Steinmann à 6 mm Ø
para agujas de Kirschner y clavos de Steinmann hasta 6 mm Ø
per fili Kirschner e chiodi Steinmann fino a 6 mm Ø

1:3

Drahtschneidezangen
Wire cutting forceps

Pinces coupantes
Alicates para cortar alambre
Pinze taglia filo



185 cm - 7 $\frac{1}{4}$ "

tk 38560-04

Kopfschneider, durchbohrt für harte Drähte bis 1.6 mm Ø
Wire cutting forceps for hard wires up to 1.6 mm Ø

Pince coupante pour fils durs à 1.6 mm Ø
Alicates para alambres duros hasta 1.6 mm Ø
Pinza taglia fili per fili duri fino a 1.6 mm Ø



260 mm - 10 $\frac{1}{4}$ "

tk 38560-26 tucar

für harte Drähte bis 3 mm Ø
for hard wires up to 3 mm Ø

pour fils durs à 3 mm Ø
para alambres duros hasta 3 mm Ø
per fili duri fino a 3 mm Ø

TUCAR

Technische Zangen
Technical forceps

Pinces techniques
Pinzas tecnicas
Pinze tecniche



130 mm - 5"	tk 38562-13
180 mm - 7"	tk 38562-18



140 mm - 5½"	tk 38563-14
170 mm - 6¾"	tk 38563-17



	180 mm - 7"	180 mm - 7"
x = 5 mm	tk 38564-05	tk 38571-05 tucar
x = 7 mm	tk 38564-07	tk 38571-07 tucar

TUCAR

Technische Zangen
Technical forceps

Pinces techniques
Pinzas tecnicas
Pinze tecniche



170 mm - 6¾"
tk38565-17



220 mm - 8¾" **tk38565-22 tucar**

Grip-Zange, kombiniert mit TC-Schneider
Grip forceps, combined with TC-Cutter

Pince grip, avec partie coupante TC
Pinza grip, con parte cortante TC
Pinza grip, con morso tagliante a TC



190 mm - 7½" **tk38565-19**

Technische Zange, verstellbar
Technical forceps, adjustable

Pince technique, ajustable
Pinza tecnica, ajustable
Pinza tecnica, regolabile

Technische Zangen
Technical forceps

Pinces techniques
Pinzas técnicas
Pinze tecniche



185 mm - 7 1/4" **tk 38569-17**

Flachzange
Flat nose plier

Pince platte
Alicate plano
Pinza piatta



185 mm - 7 1/4" **tk 38569-01**

Flachzange mit Seitenschneider, parallel-
fassend, für harte Drähte bis 1.6 mm Ø

Flat nose plier, parallel grip, incorporated
cutter, for hard wires up to 1.6 mm Ø

Pince à couder avec coupe latéral,
pour des fils durs à de 1.6 mm Ø

Pinza para torcer con corte lateral,
para alambres hasta 1.6 mm Ø

Pinza, morso piatto parallelo e taglia
fili laterale fino a 1.6 mm Ø



180 mm - 7" **tk 38573-18**

200 mm - 8" **tk 38573-20**

240 mm - 9 1/2" **tk 38573-24**

Feststellzange
Locking plier

Pince à caler
Pinza de fijar
Pinza bloccante

Technische Zangen
Technical forceps

Pinces techniques
Pinzas tecnicas
Pinze tecniche



	a	b	c
tk 38573-05	220 mm	4,5 mm	54 mm
tk 38573-03	250 mm	5,5 mm	66 mm
tk 38573-04	300 mm	7,0 mm	78 mm

Feststellzange, allein
Locking plier, only

Pince à caler, seul
Pinza de fijar, sola,
Pinza bloccante, sola

300 mm - 12" **tk 38573-08**

Feststellzange mit Aufnahmestift
Locking plier with holding pins

Pince à caler avec groupilles
Pinza de fijar con pivotes
Pinza bloccante con perni per estrattore

460 mm - 18" **tk 38573-09**

Feststellzange mit Ausschlagvorrichtung
Locking plier with extraction device

Pince à caler avec devis d'extraction
Pinza de fijar con dispositivo de extracción
Pinza bloccante con estrattore

Technische Zangen
Technical forceps

Pinces techniques
Pinzas tecnicas
Pinze tecniche



200 mm - 8" | **tk 38573-01**

Plattenbiegezange für Knochenplatten bis 2.7 mm Stärke
Plate bending plier for plates up to 2.7 mm
Pince à couder pour des plaques de 2.7 mm
Pinza para torcer, placas hasta 2.7 mm
Pinza piega placche fino a 2.7 mm

240 mm - 9½" | **tk 38573-02**

Plattenbiegezange für Knochenplatten bis 4 mm Stärke
Plate bending plier for plates up to 4 mm
Pince à conder pour des plaques de 4 mm
Pinza para torcer, para placas hasta 4 mm
Pinza piega placche fino a 4 mm



Bitte fordern Sie unseren Spezialkatalog für Traumatologie an.
Please ask for our special catalogue for traumatology.

Veillez demander pour notre catalogue spécial pour la traumatologie.

Por favor preguntan para el catalogo especial para la traumatología.

Per favore domandate per il nostro catalogo speciale per la traumatologia.

Extensionsbügel
Extension bows

Etriers pour extension
Estribos para extensión
Archi per estensione



tk 38583-18 180 mm - 7"

Spannschlüssel für Kirschner Drähte
Wire strainer for Kirschner wires
Tendeur pour fils de Kirschner
Tensor para agujas de Kirschner
Chiave per estensione di fili Kirschner

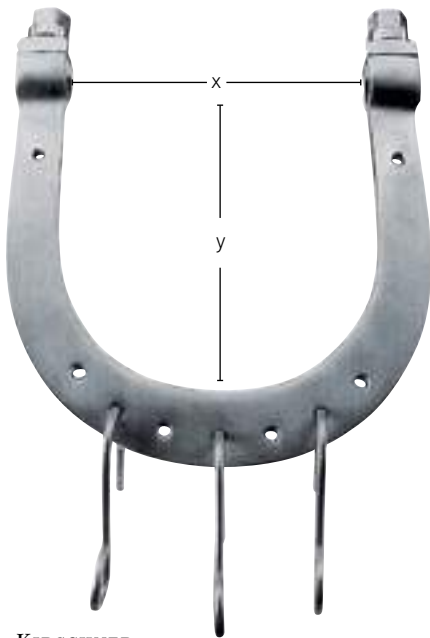

KIRSCHNER

x = 95 mm y = 70 mm	tk 38580-01
x = 100 mm y = 100 mm	tk 38580-02
x = 120 mm y = 120 mm	tk 38580-03
x = 155 mm y = 155 mm	tk 38580-04
x = 200 mm y = 155 mm	tk 38580-05

mit 3 Zughaken
with 3 traction hooks
avec 3 crochets d'attelage
con 3 ganchos de tracción
con 3 ganci di trazione



KIRSCHNER

x = 130 mm	tk 38581-01
x = 185 mm	tk 38581-02
x = 220 mm	tk 38581-03

mit 3 Zughaken
with 3 traction hooks
avec 3 crochets d'attelage
con 3 ganchos de tracción
con 3 ganci di trazione

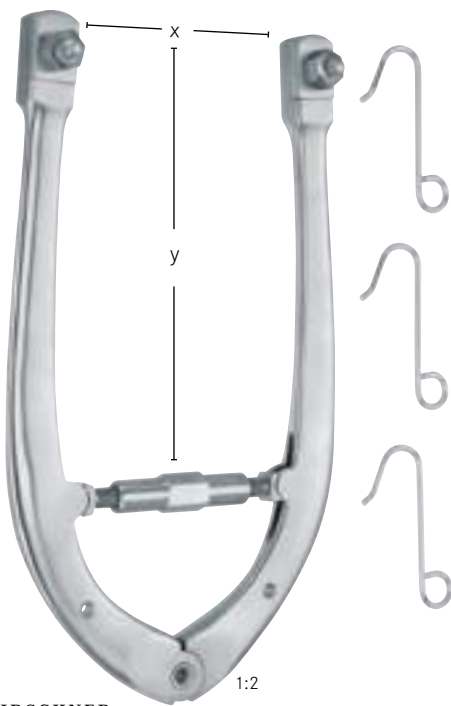
Extensionsbügel
Extension bows
Etriers pour extension
Estribos para extensión
Archi per estensione

KIRSCHNER

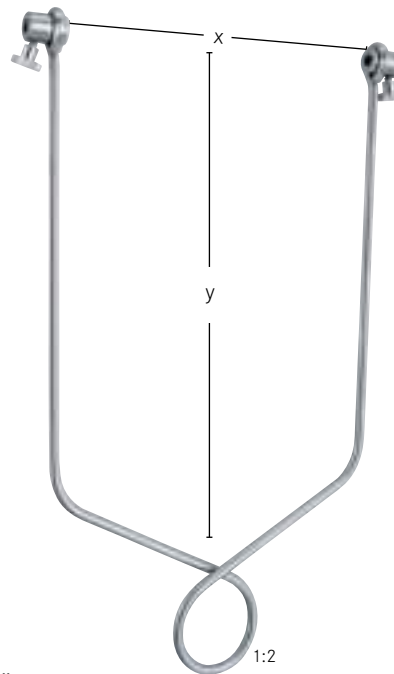
x = 180 mm	y = 100 mm	tk 38582-01
x = 270 mm	y = 160 mm	tk 38582-02

mit 3 Zughaken
with 3 traction hooks
avec 3 crochets d'attelage
con 3 ganchos de tracción
con 3 ganci di trazione

BÖHLER

x = 75 mm	y = 90 mm	tk 38596-75
x = 90 mm	y = 160 mm	tk 38597-90
x = 110 mm	y = 210 mm	tk 38598-11
x = 150 mm	y = 210 mm	tk 38598-21



	14 mm / 17 mm
190 mm - 7½"	tk 38584-19

Gabelschlüssel
Wrench
Clé de serrage
Llave de tuercas
Chiave per madreviti

Amputationsretraktor – Komprimeter
Amputation retractor – Comprimeter

Rétracteur pour amputation – Comprimètre
Retractor para amputación – Comprimetro
 Retrattore per amputazione – Comprimetro



PERCY

1:3

tk 38599-00

Griffe abnehmbar, einfaches Modell
Handles detachable, simple pattern
 Manches à détacher, modèle simple
Mango desmontable, modelo simple
 Manici demontabili, modello semplice



tk 4720-00

Komprimeter, bestehend aus Arm- und Oberschenkelmanschette,
 Manometer justiert bis 700 mm Hg und Metallpumpe
*Comprimeter, consisting of arm and upper thigh cuff,
 manometer calibrated up to 700 mm Hg, with metal pump*
 Comprimètre se composant du brassard pour bras et cuisse,
 manomètre calibré jusqu'à 700 mm Hg, avec pompe métallique
*Comprimetro, se compuesto de brazaletes para brazo y muslo,
 manómetro calibrado hasta 700 mm Hg, con bomba metálica*
 Comprimetro, composto da torniquete, due bracciali e pompa d'aria
 e manometro graduato fino a 700 mm Hg

Handbohrapparate
Hand drills

Perforateurs à main
Perforadores de mano
Perforatori a mano



Leichtmetallgehäuse
Light metal housing
Carcasse en métal léger
Carcasa en metal ligero
In scatola di alluminio

Längsdurchbohrt
Longitudinally cannulated
À perforation axiale
Taladrado longitudinalmente
Forato longitudinalmente

BUNELL

160 mm - 6 1/4" **tk 24860-00**

Öffnung bis 4 mm Ø
Opening up to 4 mm Ø

Ouverture jusqu'à 4 mm Ø
Apertura hasta 4 mm Ø
Apertura fino à 4 mm Ø



RALK

160 mm - 6 1/4" **tk 24862-00**

Öffnung bis 6,35 mm Ø
Opening up to 6.35 mm Ø

Ouverture jusqu'à 6.35 mm Ø
Apertura hasta 6.35 mm Ø
Apertura fino à 6.35 mm Ø

Leichtmetallgehäuse
Light metal housing

Carcasse en métal léger
Carcasa en metal ligero
In scatola di alluminio

Längsdurchbohrt
Longitudinally cannulated

À perforation axiale
Taladrado longitudinalmente
Forato longitudinalmente

tk 24860-01

Ersatzschlüssel für tk 24860-00 und 24862-00
Spare key for tk 24860-00 and 24862-00

Clé de réchange pour tk 24860-00 et 24862-00
Llave de recambio para tk 24860-00 y 24862-00
Chiave di ricambio per tk 24860-00 e 24862-00

Handbohrapparate
Hand drills

Perforateurs à main
Perforadores de mano
Perforatori a mano



STILLE

200 mm - 8"

tk 24855-00

komplett mit 9 Bohrern (Fig. 1 - Fig. 9)
complete with 9 twist drills (Fig. 1 - Fig. 9)

complet avec 9 mèches (Fig. 1 - Fig. 9)

completa con 9 fresas (Fig. 1 - Fig. 9)

completa con 9 frese (Fig. 1 - Fig. 9)

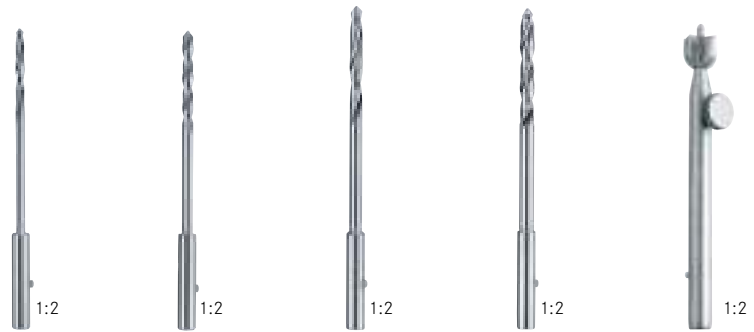

Fig. 1	Fig. 2	Fig. 3	Fig. 4	Fig. 5
2.5 mm Ø	3.0 mm Ø	3.5 mm Ø	4.0 mm Ø	10.0 mm Ø
tk 24855-01	tk 24855-02	tk 24855-03	tk 24855-04	tk 24855-05



Fig. 6	Fig. 7	Fig. 8	Fig. 9
5.0 mm Ø	8.0 mm Ø	12.0 mm Ø	16.0 mm Ø
tk 24855-06	tk 24855-07	tk 24855-08	tk 24855-09



Fig. 10	Fig. 11	Fig. 12
1.0 mm Ø	1.5 mm Ø	2.0 mm Ø
tk 24855-10	tk 24855-11	tk 24855-12

Handbohrapparate
Hand drills

Perforateurs à main
Perforadores de mano
Perforatori a mano

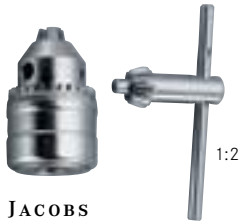

JACOBS

280 mm – 11"

tk 24864-06

Öffnung bis 6,35 mm Ø
Opening up to 6.35 mm Ø
Ouverture jusqu'à 6.35 mm Ø
Apertura hasta 6.35 mm Ø
Apertura fino à 6.35 mm Ø



tk 24859-06

Öffnung bis 6,35 mm Ø
Opening up to 6.35 mm Ø
Ouverture jusqu'à 6.35 mm Ø
Apertura hasta 6.35 mm Ø
Apertura fino à 6.35 mm Ø



280 mm – 11"

tk 24863-00

Handbohrapparat, rostfrei, beweglicher Griff, mit „Jacobs“-Spannfutter und Schlüssel
Hand drill, stainless, adjustable handle, with „Jacobs“-chuck and key

Perceuse mécanique en acier inox, manche mobil, avec mandrin «Jacobs» et clé
Taladradora a mano, mango mobil, acero inoxidable, porta brocas «Jacobs» y llave
Perforatore a mano, inossidabile, manico da muovere, con morso «Jacobs» e chiave

1:3



Bitte fordern Sie unseren Spezialkatalog für die Akku betriebenen „MOBI Power Tools“ an.
Please ask for our special catalogue about battery powered “MOBI Power Tools”.

Veuillez demander pour notre catalogue special «MOBI Power Tools» fonctionnement à piles.

Por favor pida por nuestro catalogo especial “MOBI Power Tools” con batteria.

Per favore domandate per il nostro catalogo special per i “MOBI Power Tools” a batteria.

Spiralbohrer – Pfrieme
Twist drills – Reamers

Mêches – Alênes
Taladros espirales – Escariadores
Punte a spirale – Perforatori a mano

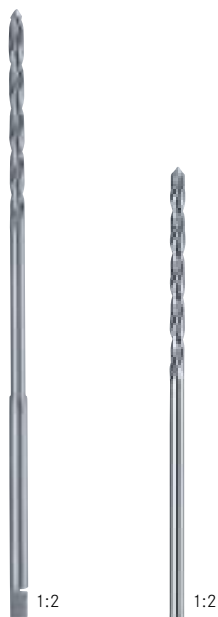

1.0 mm Ø		tk 24885-10
1.5 mm Ø		tk 24885-15
2.0 mm Ø	tk 24880-20	tk 24885-20
2.5 mm Ø	tk 24880-25	tk 24885-25
2.8 mm Ø		tk 24885-28
3.0 mm Ø	tk 24880-30	tk 24885-30
3.2 mm Ø	tk 24880-32	tk 24885-32
3.5 mm Ø	tk 24880-35	tk 24885-35
4.0 mm Ø	tk 24880-40	tk 24885-40
5.0 mm Ø	tk 24880-50	tk 24885-50
6.0 mm Ø	tk 24880-60	tk 24885-60
7.0 mm Ø	tk 24880-70	tk 24885-70

PERTHES

180 mm – 7"	tk 24899-18
210 mm – 8¼"	tk 24899-21

AO Schaft <i>AO shank</i>	Rundschaft <i>Round shank</i>
Raccord AO <i>Connector AO</i>	Tige ronde <i>Tija redonda</i>
Attacco AO	Asta rotondo

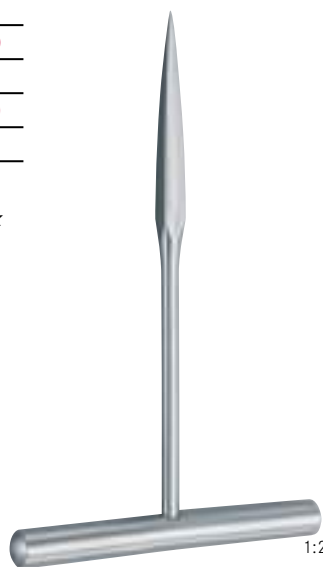

140 mm – 5½"
tk 24864-14



140 mm – 5½"
tk 24898-14



Mikro- und Neurochirurgie
Micro- and neuro surgery

Chirurgie micro et neuro
Cirugía micro y neuro
Micro- e Neuro-Chirurgia

Schädelhalter
Cervical traction tongs

Pinces de traction crânienne
Pinzas de traccion cranial
Pinze per trazione craniale



CRUTCHFIELD
tk 24900-00

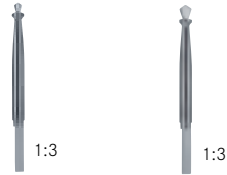

	3.5 mm Ø	5.0 mm Ø
tk 24901-02	x	x



CRUTCHFIELD
tk 24901-00

Satz à 2 Stück für tk 24900-00 und tk 24901-00
Set of 2 pieces for tk 24900-00 and tk 24901-00

Jeu à 2 pièces pour tk 24900-00 et pour tk 24901-00
Juego con 2 piezas para tk 24900-00 y para tk 24901-00
Completo con 2 pezzi per tk 24900-00 e per tk 24901-00



tk 24903-00

grosses Modell, für Extension der Halswirbel – kein Vorbohren erforderlich – Dorne verstellbar

large type, cervical traction tongs – pins adjustable no drilling to be done

modèle large, distracteur cervicale – poinçons ajustables pas de perçage nécessaire

modelo grande, distractor cervical – espigas ajustables sin necesidad de trepanar

modello grande, distrattore cervicale, pin ajustabili, non necessita di perforare, regolabili

tk 24903-01

Ersatzdorn für tk 24903-00
Spare pin for tk 24903-00

Goupille de rechange pour tk 24903-00
Pivote de cambio para tk 24903-00

Punta di ricambio tk 24903-00



tk 38584-19

Gabelschlüssel, doppelendig zu tk 24903-00
Wrench, double-ended for tk 24903-00

Clé de fixation, pour tk 24903-00
Llave de tuercas, para tk 24903-00

Chiave per tk 24903-00

Handbohrapparate
Hand drills

Perforateurs à main
Perforadores a mano
Perforatori a mano



HUDSON

270 mm - 10³/₄" **tk 24850-00**

komplett mit 4 Bohrern (Fig. 1 - Fig. 4) und Verlängerungsstück
complete with 4 twist drills (Fig. 1 - Fig. 4) and extension piece
complet avec 4 mèches (Fig. 1 - Fig. 4) et pièce d'extension
completa con 4 fresas (Fig. 1 - Fig. 4) y pieza de prolongación
completo con 4 frese (Fig. 1 - Fig. 4) e pezzo di prolungazione



tk 24851-00

Verlängerungsstück
Extension piece
Pièce d'extension
Pieza de prolongación
Pezzo di prolungazione



Fig. 1	Fig. 2	Fig. 3	Fig. 4
9 mm Ø	14 mm Ø	16 mm Ø	22 mm Ø
tk 24851-01	tk 24851-02	tk 24851-03	tk 24851-04



CUSHING

14 mm Ø

tk 24854-05



MCKENZIE

13 mm Ø

tk 24854-09

Instrumente zur Schädelöffnung
Instruments for cranial opening

Instrumentos para l'apertura del crâne
Strumenti per l'apertura del cranio



1:2

DE MARTEL

330 mm - 13"

tk 24912-33



1:2

ADSON

150 mm - 6"

tk 24907-15



1:2

DE VILBISS

210 mm - 8 1/4"

tk 24909-21

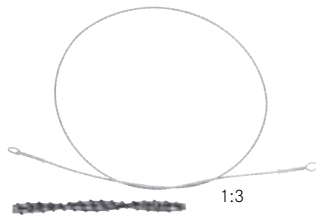

1:3

OLIVECRONA

300 mm - 12" - 1.2 mm Ø

tk 24915-30

400 mm - 16" - 1.2 mm Ø

tk 24915-40

500 mm - 20" - 1.2 mm Ø

tk 24915-50

600 mm - 23 1/2" - 1.2 mm Ø

tk 24915-60

700 mm - 27 1/2" - 1.2 mm Ø

tk 24915-70

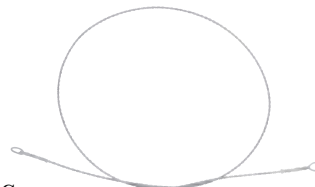

1:3

GIGLI

300 mm - 12" - 1.4 mm Ø

tk 24917-30

400 mm - 16" - 1.4 mm Ø

tk 24917-40

500 mm - 20" - 1.4 mm Ø

tk 24917-50



1:2

GIGLI

tk 24916-00

Selbsthaltender Retraktor
Self-retaining retractor

Retracteur autostatique
Separador autostatico
Retratore autostatico



tk 24920-00

Selbsthaltender Retraktor, flexibel mit 1 Spannarm, komplett, bestehend aus: Fixierungsvorrichtung für 1 Spannarm, Spannarm und Spatelhalter für flache Spatel

Retractor self-retaining, with 1 flexible arm, complete, consisting of: fixation base for 1 flexible arm, flexible arm only, support for flat brain spatulas

Retracteur autostatique, flexible avec 1 tendeur, complét avec support pour 1 tendeur, tendeur et porte-spatule pour spatules plates

Separador autostatico, 1 brazo flexible con soporte, completo con brazo y soporte para spatulas llanas

Retratore autostatico, flessibile Completo, contiene: supporto di fissaggio per un braccio, 1 braccio flessibile con supporto di fissaggio per spatole piatte

tk 24922-00

Selbsthaltender Retraktor, flexibel mit 2 Spannarmen, komplett, bestehend aus: Fixierungsvorrichtung für 2 Spannarme, 2 Spannarme und 2 Spatelhalter für flache Spatel

Retractor self-retaining, with 2 flexible arms, complete, consisting of: fixation base for 2 flexible arms, 2 flexible arms, 2 supports for flat brain spatulas

Retracteur autostatique, flexible avec 2 tendeurs, complét avec supports pour 2 tendeurs, 2 tendeurs et 2 portes-spatule pour spatules plates

Separador autostatico, 2 brazos flexibles con soporte, completo con brazos y soporte para 2 spatulas llanas

Retratore autostatico, flessibile con 2 bracci completi, contiene: supporto di fissaggio per bracci per 2 spatole piatte

Selbsthaltender Retraktor
Self-retaining retractor

Retracteur autostatique
Separador autostatico
Retrattore autostatico



tk 24922-02

Fixierungsvorrichtung allein, für 2 Spannarme
Fixation base only, holding 2 flexible arms

Support seul pour 2 tendeurs
Soporte solo para 2 brazos de separador
Supporto di fissaggio per 2 bracci, solo

tk 24920-02

Fixierungsvorrichtung allein, für 1 Spannarm
Fixation base only, holding 1 flexible arm

Support seul pour 1 tendeur
Soporte solo para 1 brazo de separador
Supporto di fissaggio per 1 braccio, solo

tk 24925-02

Spatelhalter allein, für Flachspatel
Support only, for flat brain spatulas

Porte-spatule seul, pour spatules plates
Soporte solo, para spatulas planos
Supporto solo, per fissaggio di spatole piatte

tk 24925-01

Spatelhalter allein, für Spatel mit Rundschaft
von 4 mm und 5 mm Ø, zum Befestigen am Spannarm

*Support only, for brain spatulas with round shaft
of 4 mm and 5 mm Ø to fix on the flexible arm*

Porte-spatule seul pour la fixation des spatules
de 4 mm et 5 mm Ø diam

*Soporte solo para la fijación de spatulas
de 4 mm y 5 mm Ø al brazo*

Supporto solo per spatole con asta tonda
di Ø 4 mm e 5 mm

tk 24926-00

Spannarm allein – zum Aufstecken auf Kupplungsköpfe
und Fixierungsvorrichtungen

*Flexible arm only – for attaching coupling heads and
for fixation bases*

Tendeur flexible seul – pour le montage sur supports
et accouplements

Brazo flexible solo para montar sobre soportes

Braccio flessibile solo – per il montaggio sul supporto
di fissaggio

McKenzie Instrumentarium
McKenzie instruments

McKenzie instruments
Instrumentos McKenzie
Strumenti McKenzie

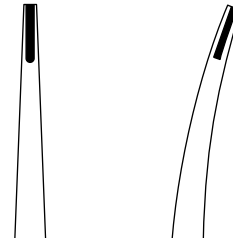

MCKENZIE

150 mm – 6"	tk 25020-15	tk 25021-15
190 mm – 7½"	tk 25020-19	tk 25021-19

Zangen zum Anlegen der Klammern

Clip applying forceps

Pinces pour poser des agrafes

Pinzas para poner grapas

Pinze per mettere leagraffes



1:2

MCKENZIE

148 mm x 40 mm x 6 mm – 5¾" x 1½" x ½"	tk 25001-00
--	--------------------

Klammerblock für 20 Klammern

Brain clip-rack for 20 clips

Porte-agrafes pour 20 agrafes

Porta-grapas para 20 grapas

Supporto port'agraffes per 20 agraffes

Clips und Anlegezangen
Clips and applying forceps

Clips et pinces à appliquer
Clips y aplicadores
Clips e pinze per mettere clips



OLIVECRONA-TOENNIS
(SCOVILLE)

x = 140 mm - 5 1/2" | **tk 25010-24**



RANEY

150 mm - 6" | **tk 25040-15**

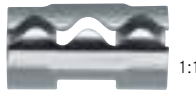

tk 25039-00

Kopfhautklammer „Raney“
Scalpclip „Raney“

Agrafes pour le cuir chevelu «Raney»
Grapa para cuero cabelludo "Raney"
Agrafes per il cuoio capelluto „Raney“

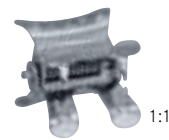

tk 25038-00

Kopfhautklammer „Köln“
Scalpclip „Köln“

Agrafes pour le cuir chevelu «Köln»
Grapa para cuero cabelludo "Köln"
Agrafes per il cuoio capelluto „Köln“

Anlegezangen für Yasargil Clips
Applying forceps for Yasargil clips

Pince à poser pour des clips Yasargil
Aplicadora para clips Yasargil
Pinze per mettere clips Yasargil

Biegbares Memory-Metall: verformt sich bei Sterilisation (> 80°C) automatisch in den ursprünglich geraden Zustand.

Malleable Memory Metal: transforms during sterilization (> 80°C) automatically into originally straight form.

Malléable Memory-Métal: se retransforme pendant la stérilisation (> 80°) automatiquement dans la forme originale droit.

Malleable Memory-Metal: se transforma durante la esterilización (> 80°C) automáticamente en la forma original recta.

Metallo malleabile con effetto memoria: se deformato ritorna automaticamente alla forma originale con una sterilizzazione ad una temperatura maggiore di 80°C.



1:2





STANDARD		
PHYNOX 	x = 70 mm - 2¾"	tk 25091-07
	x = 90 mm - 3½"	tk 25091-09
	x = 110 mm - 4⅓"	tk 25091-11

MINI		
PHYNOX 	x = 70 mm - 2¾"	tk 25191-07
	x = 90 mm - 3½"	tk 25191-09
	x = 110 mm - 4⅓"	tk 25191-11

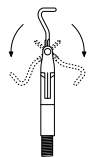
drehbar
rotating
rotatif
rotatorio
rotante



STANDARD		
TITAN 	x = 70 mm - 2¾"	tk 25291-07
	x = 90 mm - 3½"	tk 25291-09
	x = 110 mm - 4⅓"	tk 25291-11

MINI		
TITAN 	x = 70 mm - 2¾"	tk 25391-07
	x = 90 mm - 3½"	tk 25391-09
	x = 110 mm - 4⅓"	tk 25391-11

drehbar
rotating
rotatif
rotatorio
rotante

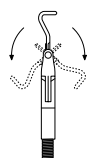

Anlegezangen für Yasargil Clips
Applying forceps for Yasargil clips

Pince à poser pour des clips Yasargil
Aplicadora para clips Yasargil
 Pinze per mettere clips Yasargil



STANDARD

TITAN		x = 90 mm - 3 1/2"	tk 25093-06	tk 25095-06
		x = 110 mm - 4 1/3"	tk 25093-07	tk 25095-07

MINI

TITAN		x = 90 mm - 3 1/2"	tk 25092-06	tk 25094-06
		x = 110 mm - 4 1/3"	tk 25092-07	tk 25094-07

nicht drehbar
non rotating
 non rotatif
no rotatorio
 non rotante

drehbar
rotating
 rotatif
rotatorio
 rotante

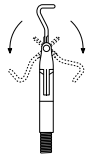

1:2

Anlegezangen für Yasargil Clips
Applying forceps for Yasargil clips

Pince à poser pour des clips Yasargil
Aplicadora para clips Yasargil
 Pinze per mettere clips

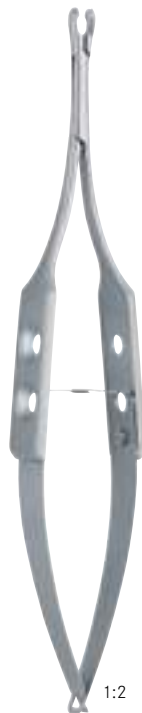

	MINI	STANDARD
170 mm - 6¾"		
180 mm - 7"	tk 25088-18	tk 25089-18
210 mm - 8¼"		
230 mm - 9"		

gerade, mit Sperre
straight, with ratchet
 droit, avec verrou
recta, con cierre
 retta, con cremagliera

	MINI	STANDARD
	tk 25090-17	tk 25091-17
	tk 25090-21	tk 25091-21
	tk 25090-23	tk 25091-23

bayonett-förmig, mit Sperre
bayonett shaped, with ratchet
 en baionette, avec verrou
forma bayoneta, con cierre
 forma baionetta, con cremagliera

Aneurysmen Gefäßclips
Aneurysm vessel-clips

Anévrisme clips
Aneurisma clips
Clips per aneurisma e vasi

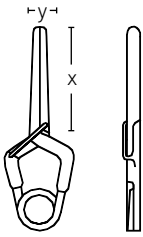

x = Maullänge
x = Jaw length

x = Longueur du mors
x = Longitud de la boca
x = Lunghezza del morso

y = max. Maulöffnung
y = max. opening

y = Ouverture max. du mors
y = Apertura max. de la boca
y = Apertura mass. del morso

gms = Schließkraft
gms = Pressure

gms = Force de fermeture
gms = Presión
gms = Sforza della chiusura



Bei Bestellung von Titan Clips, bitte der Artikelnummer ein „T“ hinzufügen.

For titanium clips, please add a "T" to the reference number.

Pour des clips en titane, veuillez ajouter un «T» à la référence.

Para clips de titanio, por favor añadir und "T" a la referencia.

Per clips in titanio, per favore aggiuntete al numero d'articolo un "T".



YASARGIL-STANDARD

für permanenten Verschluss, aus hochwertigem Implantatstahl, antimagnetisch
for permanent closure, in high quality implant steel, antimagnetic

pour fermeture permanente, acier de haute qualité, anti-magnétique
para oclusión permanente, acero de alta calidad, antimagnetico

per chiusura permanente, acciaio di alta qualità, antimagnetico

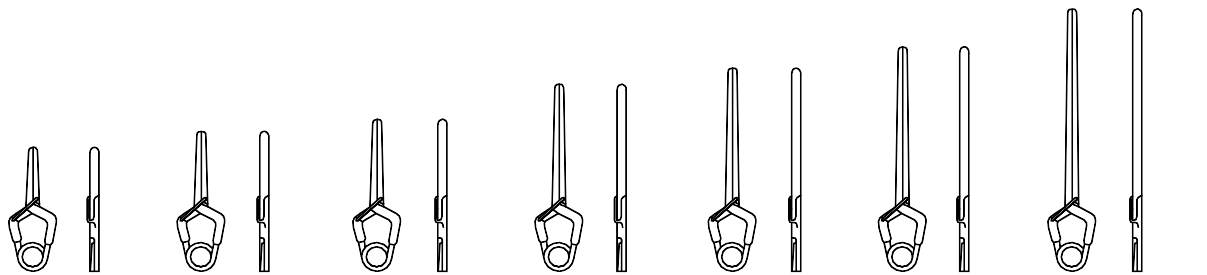

x = 7.0 mm	x = 9.0 mm	x = 11.0 mm	x = 15.0 mm	x = 17.0 mm	x = 20.0 mm	x = 25.0 mm
y = 6.2 mm	y = 7.0 mm	y = 7.8 mm	y = 9.2 mm	y = 10.6 mm	y = 11.4 mm	y = 13.3 mm
gms = 150	gms = 180	gms = 180	gms = 200	gms = 200	gms = 200	gms = 200
tk 25096-00	tk 25097-00	tk 25098-00	tk 25099-00	tk 25100-00	tk 25101-00	tk 25102-00

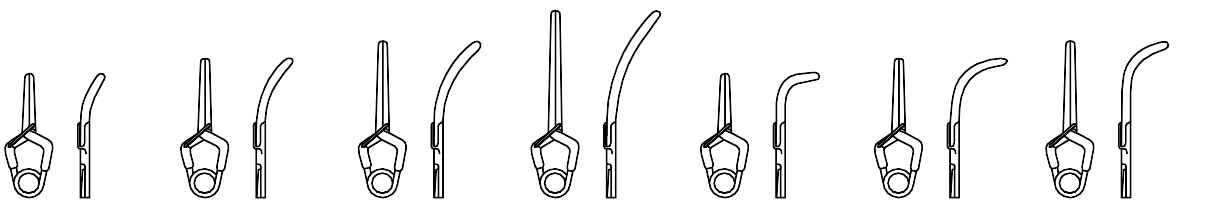

x = 7.0 mm	x = 9.0 mm	x = 11.0 mm	x = 15.0 mm	x = 7.0 mm	x = 9.0 mm	x = 11.0 mm
y = 6.0 mm	y = 6.8 mm	y = 7.5 mm	y = 8.7 mm	y = 5.5 mm	y = 6.1 mm	y = 6.5 mm
gms = 150	gms = 180	gms = 180	gms = 200	gms = 150	gms = 180	gms = 180
tk 25103-00	tk 25104-00	tk 25105-00	tk 25106-00	tk 25107-00	tk 25108-00	tk 25109-00

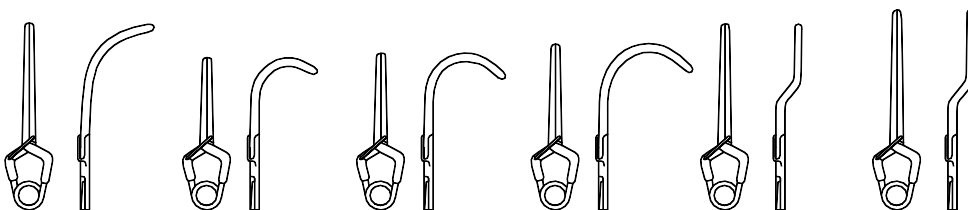

x = 15.0 mm	x = 7.0 mm	x = 9.0 mm	x = 11.0 mm	x = 7.0 mm	x = 9.0 mm
y = 7.4 mm	y = 5.4 mm	y = 5.8 mm	y = 6.2 mm	y = 7.9 mm	y = 8.7 mm
gms = 200	gms = 180	gms = 180	gms = 180	gms = 200	gms = 200
tk 25110-00	tk 25111-00	tk 25112-00	tk 25113-00	tk 25114-00	tk 25115-00

Aneurysmen Gefäßclips
Aneurysm vessel-clips

Anévrisme clips
Aneurisma clips
Clips per aneurisma e vasi

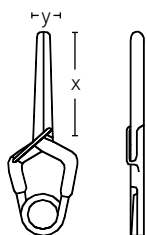

x = Maullänge
x = Jaw length

x = Longueur du mors
x = Longitud de la boca
x = Lunghezza del morso

y = max. Maulöffnung
y = max. opening

y = Ouverture max. du mors
y = Apertura max. de la boca
y = Apertura mass. del morso

gms = Schließkraft
gms = Pressure

gms = Force de fermeture
gms = Presión
gms = Sforza della chiusura



Bei Bestellung von Titan Clips, bitte der Artikelnummer ein „T“ hinzufügen.

For titanium clips, please add a "T" to the reference number.

Pour des clips en titane, veuillez ajouter un «T» à la référence.

Para clips de titanio, por favor añadir und "T" a la referencia.

Per clips in titanio, per favore aggiuntete al numero d'articolo un "T".



YASARGIL-STANDARD

für permanenten Verschluss, aus hochwertigem Implantatstahl, antimagnetisch
for permanent closure, in high quality implant steel, antimagnetic

pour fermeture permanente, acier de haute qualité, anti-magnétique

para oclusión permanente, acero de alta calidad, antimagnético

per chiusura permanente, acciaio di alta qualita, antimagnetico

x = 12.0 mm	x = 17.0 mm	x = 20.0 mm	x = 5.0 mm	x = 7.0 mm	x = 9.0 mm	x = 11.0 mm	
y = 10.2 mm	y = 11.9 mm	y = 13.0 mm	y = 6.2 mm	y = 6.5 mm	y = 7.8 mm	y = 8.4 mm	
gms = 200	gms = 180	gms = 180	gms = 200	gms = 200	gms = 200	gms = 200	gms = 200
tk 25116-00	tk 25117-00	tk 25118-00	tk 25119-00	tk 25120-00	tk 25121-00	tk 25122-00	

x = 5.0 mm	x = 7.0 mm	x = 10.0 mm	x = 8.0 mm	x = 10.0 mm	x = 5.0 mm
y = 5.6 mm	y = 5.6 mm	y = 5.6 mm	y = 5.4 mm	y = 5.6 mm	y = 7.2 mm
gms = 200	gms = 200	gms = 200	gms = 200	gms = 200	gms = 200
tk 25123-00	tk 25124-00	tk 25125-00	tk 25126-00	tk 25127-00	tk 25128-00

x = 9.0 mm	x = 11.0 mm	x = 7.0 mm	x = 11.0 mm	x = 9.0 mm
y = 7.2 mm	y = 8.2 mm	y = 5.7 mm	y = 8.0 mm	y = 6.2 mm
gms = 200	gms = 200	gms = 200	gms = 200	gms = 200
tk 25129-00	tk 25130-00	tk 25131-00	tk 25132-00	tk 25133-00

Aneurysmen Gefäßclips
Aneurysm vessel-clips

Anévrisme clips
Aneurisma clips
Clips per aneurisma e vasi

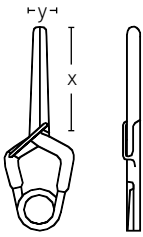

x = Maullänge x = <i>Jaw length</i>	y = max. Maulöffnung y = <i>max. opening</i>	gms = Schließkraft gms = <i>Pressure</i>
x = Longueur du mors x = <i>Longitud de la boca</i>	y = Ouverture max. du mors y = <i>Apertura max. de la boca</i>	gms = Force de fermeture gms = <i>Presión</i>
x = Lunghezza del morso	y = Apertura mass. del morso	gms = Sforza della chiusura



Bei Bestellung von Titan Clips, bitte der Artikelnummer ein „T“ hinzufügen.

For titanium clips, please add a "T" to the reference number.

Pour des clips en titane, veuillez ajouter un «T» à la référence.

Para clips de titanio, por favor añadir und "T" a la referencia.

Per clips in titanio, per favore aggiuntete al numero d'articolo un "T".



YASARGIL-STANDARD

für permanenten Verschluss, mit Fenster 3,5 mm, aus hochwertigem Implantatstahl, antimagnetisch

for permanent closure, with window 3,5 mm, in high quality implant steel, antimagnetic

pour fermeture permanente, avec fenestra 3,5 mm, acier de haute qualité, anti-magnétique

para oclusión permanente, con finestra de 3,5 mm, acero de alta calidad, antimagnetico

per chiusura permanente, con finestra di 3,5 mm, acciaio di alta qualità, antimagnetico

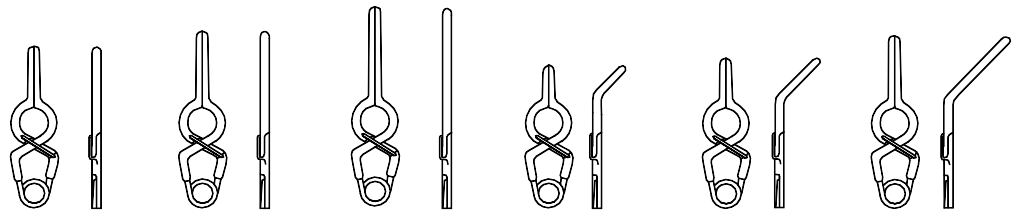

x = 7.0 mm	x = 9.0 mm	x = 12.0 mm	x = 5.0 mm	x = 7.0 mm	x = 11.0 mm
y = 7.4 mm	y = 8.4 mm	y = 9.6 mm	y = 5.8 mm	y = 6.5 mm	y = 7.2 mm
gms = 150	gms = 150	gms = 180	gms = 150	gms = 150	gms = 180
tk 25134-00	tk 25135-00	tk 25136-00	tk 25137-00	tk 25138-00	tk 25139-00

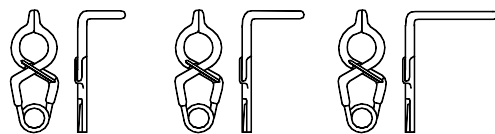

x = 5.0 mm	x = 7.0 mm	x = 11.0 mm
y = 4.9 mm	y = 4.9 mm	y = 4.9 mm
gms = 150	gms = 150	gms = 180
tk 25140-00	tk 25141-00	tk 25142-00



Aneurysmen Gefäßclips sind auch steril erhältlich
Aneurysm vessel-clips are also available sterile

Clips pour anévrismes sont également disponibles stériles

Clips para aneurisma son también disponibles estériles

Clips per aneurisma sono anche disponibili sterili

Für sterile Clips bitte der Artikelnummer ein „S“ hinzufügen
For sterile clips please add an "S" to the article number

Pour des clips stériles, ajouter un «S» à la référence

Para clips estériles añadir un "S" a la referencia

Per clips sterili, aggiuntete un "S" al numero d'articolo

Aneurysmen Gefäßclips
Aneurysm vessel-clips

Anévrisme clips
Aneurisma clips
Clips per aneurisma e vasi

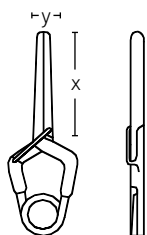

- | | | |
|-------------------------|------------------------------|-----------------------------|
| x = Maullänge | y = max. Maulöffnung | gms = Schließkraft |
| x = Jaw length | y = max. opening | gms = Pressure |
| x = Longueur du mors | y = Ouverture max. du mors | gms = Force de fermeture |
| x = Longitud de la boca | y = Apertura max. de la boca | gms = Presión |
| x = Lunghezza del morso | y = Apertura mass. del morso | gms = Sforza della chiusura |

Bei Bestellung von Titan Clips, bitte der Artikelnummer ein „T“ hinzufügen.

For titanium clips, please add a "T" to the reference number.

Pour des clips en titane, veuillez ajouter un «T» à la référence.

Para clips de titanio, por favor añadir und "T" a la referencia.

Per clips in titanio, per favore aggiuntete al numero d'articolo un "T".



YASARGIL-STANDARD

für permanenten Verschluss, mit Fenster 3,5 mm, aus hochwertigem Implantatstahl, antimagnetisch

for permanent closure, with window 3.5 mm, in high quality implant steel, antimagnetic

pour fermeture permanente, avec fenestra 3.5 mm, acier de haute qualité, anti-magnétique

para oclusión permanente, con finestra de 3.5 mm, acero de alta calidad, antimagnetico

per chiusura permanente, con finestra di 3.5 mm, acciaio di alta qualita, antimagnetico

x = 7.0 mm	x = 9.0 mm	x = 12.0 mm	x = 5.0 mm	x = 7.0 mm	x = 11.0 mm
y = 7.9 mm	y = 9.1 mm	y = 10.3 mm	y = 6.5 mm	y = 7.2 mm	y = 7.8 mm
gms = 150	gms = 150	gms = 180	gms = 150	gms = 150	gms = 180
tk 25143-00	tk 25144-00	tk 25145-00	tk 25146-00	tk 25147-00	tk 25148-00

x = 5.0 mm	x = 7.0 mm	x = 11.0 mm
y = 5.5 mm	y = 5.5 mm	y = 5.5 mm
gms = 150	gms = 150	gms = 180
tk 25149-00	tk 25150-00	tk 25151-00



Aneurysmen Gefäßclips sind auch steril erhältlich
Aneurysm vessel-clips are also available sterile

Clips pour anévrismes sont également disponibles stériles
Clips para aneurisma son también disponibles estériles
Clips per aneurisma sono anche disponibili sterili

Für sterile Clips bitte der Artikelnummer ein „S“ hinzufügen
For sterile clips please add an "S" to the article number

Pour des clips stériles, ajouter un «S» à la référence
Para clips estériles añadir un "S" a la referencia
Per clips sterili, aggiuntete un "S" al numero d'articolo

Aneurysmen Gefäßclips
Aneurysm vessel-clips

Anévrisme clips
Aneurisma clips
Clips per aneurisma e vasi

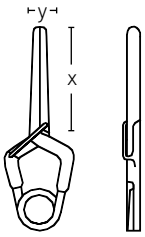

x = Maullänge
x = *Jaw length*

x = Longueur du mors
x = *Longitud de la boca*
x = Lunghezza del morso

y = max. Maulöffnung
y = *max. opening*

y = Ouverture max. du mors
y = *Apertura max. de la boca*
y = Apertura mass. del morso

gms = Schließkraft
gms = *Pressure*

gms = Force de fermeture
gms = *Presión*
gms = Sforza della chiusura



Bei Bestellung von Titan Clips, bitte der Artikelnummer ein „T“ hinzufügen.

For titanium clips, please add a "T" to the reference number.

Pour des clips en titane, veuillez ajouter un «T» à la référence.

Para clips de titanio, por favor añadir und "T" a la referencia.

Per clips in titanio, per favore aggiuntete al numero d'articolo un "T".



YASARGIL-STANDARD

für permanenten Verschluss, mit Fenster 5.0 mm, aus hochwertigem Implantatstahl, antimagnetisch

for permanent closure, with window 5.0 mm, in high quality implant steel, antimagnetic

pour fermeture permanente, avec fenestra 5.0 mm, acier de haute qualité, anti-magnétique

para oclusión permanente, con finestra de 5.0 mm, acero de alta calidad, antimagnetico

per chiusura permanente, con finestra di 5.0 mm, acciaio di alta qualità, antimagnetico

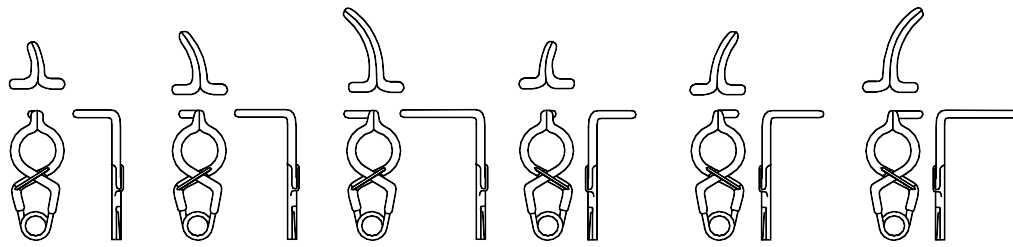

x = 5.0 mm	x = 7.0 mm	x = 10.0 mm	x = 5.0 mm	x = 7.0 mm	x = 10.0 mm
y = 5.8 mm	y = 5.8 mm	y = 5.8 mm	y = 5.8 mm	y = 5.8 mm	y = 5.8 mm
gms = 150	gms = 150	gms = 150	gms = 150	gms = 150	gms = 150
tk 25155-00	tk 25156-00	tk 25157-00	tk 25158-00	tk 25159-00	tk 25160-00

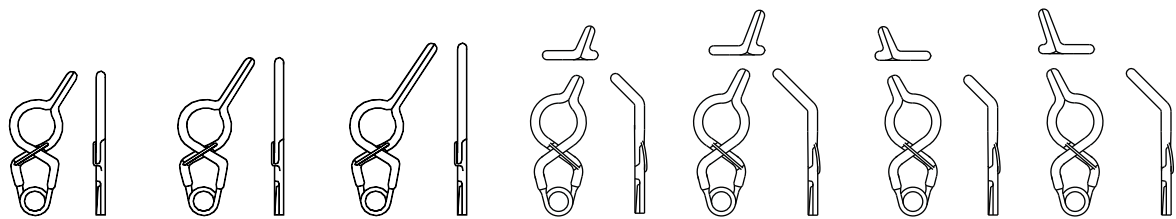

x = 5.0 mm	x = 7.0 mm	x = 10.0 mm	x = 5.0 mm	x = 7.0 mm	x = 5.0 mm	x = 7.0 mm
y = 7.0 mm	y = 7.8 mm	y = 8.8 mm	y = 5.8 mm	y = 6.2 mm	y = 5.8 mm	y = 6.2 mm
gms = 150	gms = 150	gms = 150	gms = 150	gms = 150	gms = 150	gms = 150
tk 25161-00	tk 25162-00	tk 25163-00	tk 25164-00	tk 25165-00	tk 25166-00	tk 25167-00

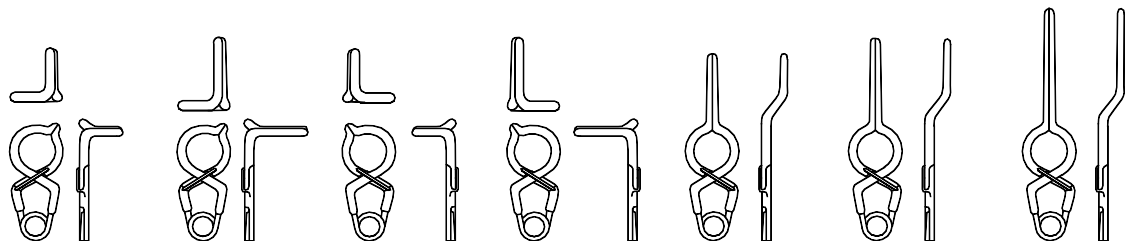

x = 5.0 mm	x = 7.0 mm	x = 5.0 mm	x = 7.0 mm	x = 5.0 mm	x = 7.0 mm	x = 11.0 mm
y = 5.6 mm	y = 5.6 mm	y = 5.6 mm	y = 5.6 mm	y = 7.9 mm	y = 8.8 mm	y = 10.0 mm
gms = 150	gms = 150	gms = 150	gms = 150	gms = 150	gms = 150	gms = 180
tk 25168-00	tk 25169-00	tk 25170-00	tk 25171-00	tk 25152-00	tk 25153-00	tk 25154-00

Aneurysmen Gefäßclips
Aneurysm vessel-clips

Anévrisme clips
Aneurisma clips
Clips per aneurisma e vasi

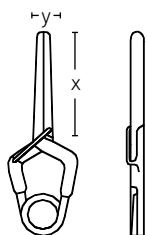

- | | | |
|-------------------------|------------------------------|-----------------------------|
| x = Maullänge | y = max. Maulöffnung | gms = Schließkraft |
| x = Jaw length | y = max. opening | gms = Pressure |
| x = Longueur du mors | y = Ouverture max. du mors | gms = Force de fermeture |
| x = Longitud de la boca | y = Apertura max. de la boca | gms = Presión |
| x = Lunghezza del morso | y = Apertura mass. del morso | gms = Sforza della chiusura |

Bei Bestellung von Titan Clips, bitte der Artikelnummer ein „T“ hinzufügen.

For titanium clips, please add a "T" to the reference number.

Pour des clips en titane, veuillez ajouter un «T» à la référence.

Para clips de titanio, por favor añadir und "T" a la referencia.

Per clips in titanio, per favore aggiuntete al numero d'articolo un "T".



YASARGIL-STANDARD

für temporären Verschluss, aus hochwertigem Implantatstahl, antimagnetisch
for temporary closure, in high quality implant steel, antimagnetic
pour fermeture temporaire, acier de haute qualité, anti-magnétique
para oclusión temporal, acero de alta calidad, antimagnetico
per uso temporaneo, acciaio di alta qualita, antimagnetico

x = 9.0 mm	x = 9.0 mm	x = 9.0 mm	x = 15.0 mm	x = 15.0 mm	x = 15.0 mm	x = 9.0 mm
y = 7.0 mm	y = 6.8 mm	y = 6.1 mm	y = 9.2 mm	y = 8.7 mm	y = 7.4 mm	y = 7.8 mm
gms = 90	gms = 90	gms = 110	gms = 90	gms = 110	gms = 110	gms = 110
tk 25172-00	tk 25173-00	tk 25174-00	tk 25175-00	tk 25176-00	tk 25177-00	tk 25178-00

x = 20.0 mm	x = 20.0 mm	x = 17.0 mm	x = 13.0 mm
y = 11.4 mm	y = 11.0 mm	y = 9.9 mm	y = 7.5 mm
gms = 110	gms = 90	gms = 90	gms = 90
tk 25179-00	tk 25180-00	tk 25181-00	tk 25182-00



Aneurysmen Gefäßclips sind auch steril erhältlich
Aneurysm vessel-clips are also available sterile

Clips pour anévrismes sont également disponibles stériles
Clips para aneurisma son también disponibles estériles
Clips per aneurisma sono anche disponibili sterili

Für sterile Clips bitte der Artikelnummer ein „S“ hinzufügen
For sterile clips please add an "S" to the article number

Pour des clips stériles, ajouter un «S» à la référence
Para clips estériles añadir un "S" a la referencia
Per clips sterili, aggiuntete un "S" al numero d'articolo

Aneurysmen Gefäßclips
Aneurysm vessel-clips

Anévrisme clips
Aneurisma clips
Clips per aneurisma e vasi

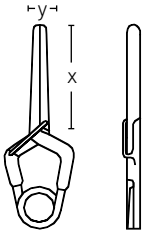

x = Maullänge	y = max. Maulöffnung	gms = Schließkraft
x = Jaw length	y = max. opening	gms = Pressure
x = Longueur du mors	y = Ouverture max. du mors	gms = Force de fermeture
x = Longitud de la boca	y = Apertura max. de la boca	gms = Presión
x = Lunghezza del morso	y = Apertura mass. del morso	gms = Sforza della chiusura



Bei Bestellung von Titan Clips, bitte der Artikelnummer ein „T“ hinzufügen.

For titanium clips, please add a "T" to the reference number.

Pour des clips en titane, veuillez ajouter un «T» à la référence.

Para clips de titanio, por favor añadir und "T" a la referencia.

Per clips in titanio, per favore aggiuntete al numero d'articolo un "T".



YASARGIL-MINI

für permanenten Verschluss, aus hochwertigem Implantatstahl, antimagnetisch
for permanent closure, in high quality implant steel, antimagnetic

pour fermeture permanente, acier de haute qualité, anti-magnétique

para oclusión permanente, acero de alta calidad, antimagnetico

per chiusura permanente, acciaio di alta qualita, antimagnetico

x = 3.0 mm	x = 5.0 mm	x = 3.0 mm	x = 5.0 mm	x = 7.0 mm	x = 3.0 mm	x = 4.0 mm
y = 3.3 mm	y = 4.0 mm	y = 3.3 mm	y = 4.0 mm	y = 4.6 mm	y = 3.2 mm	y = 3.8 mm
gms = 110	gms = 110	gms = 110	gms = 110	gms = 110	gms = 110	gms = 110
tk 25183-00	tk 25184-00	tk 25185-00	tk 25186-00	tk 25187-00	tk 25188-00	tk 25189-00

x = 4.0 mm	x = 5.0 mm	x = 4.0 mm	x = 5.0 mm	x = 7.0 mm	x = 4.0 mm	x = 4.0 mm
y = 3.6 mm	y = 3.8 mm	y = 3.6 mm	y = 4.0 mm	y = 4.4 mm	y = 3.6 mm	y = 3.5 mm
gms = 110	gms = 110	gms = 110	gms = 110	gms = 110	gms = 110	gms = 110
tk 25190-00	tk 25191-00	tk 25192-00	tk 25193-00	tk 25194-00	tk 25195-00	tk 25196-00

Aneurysmen Gefäßclips
Aneurysm vessel-clips

Anévrisme clips
Aneurisma clips
Clips per aneurisma e vasi

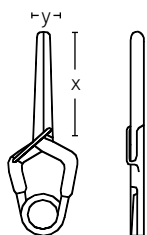

- | | | |
|-------------------------|------------------------------|-----------------------------|
| x = Maullänge | y = max. Maulöffnung | gms = Schließkraft |
| x = Jaw length | y = max. opening | gms = Pressure |
| x = Longueur du mors | y = Ouverture max. du mors | gms = Force de fermeture |
| x = Longitud de la boca | y = Apertura max. de la boca | gms = Presión |
| x = Lunghezza del morso | y = Apertura mass. del morso | gms = Sforza della chiusura |

Bei Bestellung von Titan Clips, bitte der Artikelnummer ein „T“ hinzufügen.

For titanium clips, please add a "T" to the reference number.

Pour des clips en titane, veuillez ajouter un «T» à la référence.

Para clips de titanio, por favor añadir und "T" a la referencia.

Per clips in titanio, per favore aggiuntete al numero d'articolo un "T".



YASARGIL-MINI

für temporären Verschluss, aus hochwertigem Implantatstahl, antimagnetisch
for temporary closure, in high quality implant steel, antimagnetic

pour fermeture temporaire, acier de haute qualité, anti-magnétique
para oclusión temporal, acero de alta calidad, antimagnetico
per chiusura temporanea, acciaio di alta qualita, antimagnetico

x = 5.0 mm	x = 5.0 mm	x = 6.0 mm	x = 4.0 mm	x = 7.0 mm	x = 7.0 mm
y = 4.0 mm	y = 3.5 mm	x = 6.0 mm	y = 7.0 mm	y = 5.7 mm	y = 4.5 mm
gms = 110	gms = 130	gms = 130	gms = 130	gms = 130 gms	gms = 130
tk 25197-00	tk 25198-00	tk 25199-00	tk 25200-00	tk 25201-00	tk 25202-00

x = 3.0 mm	x = 5.0 mm	x = 4.0 mm	x = 7.0 mm	x = 7.0 mm	x = 5.0 mm
y = 3.3 mm	y = 4.0 mm	y = 3.8 mm	y = 4.6 mm	y = 4.4 mm	y = 4.0 mm
gms = 90	gms = 70	gms = 70	gms = 70	gms = 70	gms = 70
tk 25203-00	tk 25204-00	tk 25205-00	tk 25206-00	tk 25207-00	tk 25208-00



Aneurysmen Gefäßclips sind auch steril erhältlich
Aneurysm vessel-clips are also available sterile

Clips pour anévrismes sont également disponibles stériles
Clips para aneurisma son también disponibles estériles
Clips per aneurisma sono anche disponibili sterili

Für sterile Clips bitte der Artikelnummer ein „S“ hinzufügen
For sterile clips please add an "S" to the article number

Pour des clips stériles, ajouter un «S» à la référence
Para clips estériles añadir un "S" a la referencia
Per clips sterili, aggiuntete un "S" al numero d'articolo

Nervenhaken
Nerve hooks

Crochets à nerfs
Ganchos para nervios
Uncini per nervi

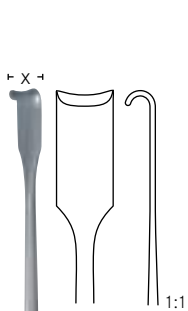

SCOVILLE
230 mm - 9"
x = 8 mm
tk 25236-23

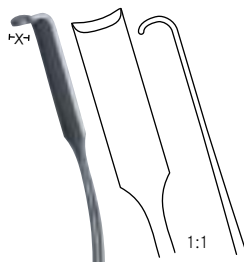

HOLSHER
240 mm - 9½"
x = 7 mm
tk 25237-24

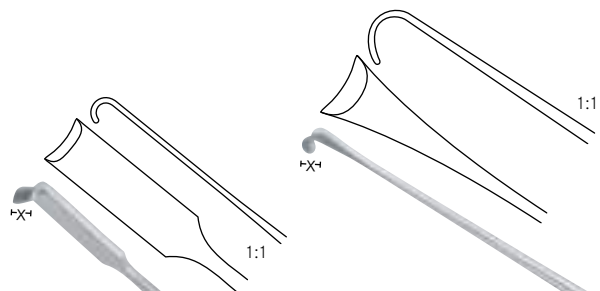

SCOVILLE
200 mm - 8"
x = 7 mm
tk 25238-19



MARTIN
210 mm - 8¼"
x = 7 mm
tk 25239-19

Duramesser
Dura knives

Bistouries pour duremère
Bisturís para duramadre
Bisturi per duramadre



1:2

TOENNIS



1:1



1:1

150 mm - 6"

190 mm - 7½"

tk 25303-13

tk 25303-19



1:2

HALLE



1:1

200 mm - 8"

tk 25304-20

Nervenhaken
Nerve hooks

Crochets à nerfs
Ganchos para nervios
Uncini per nervi



SMITHWICK

170 mm - 6 $\frac{3}{4}$ "	tk 25285-17
210 mm - 8 $\frac{1}{4}$ "	tk 25285-21

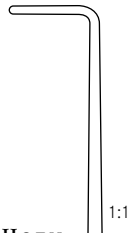

HOEN

220 mm - 8 $\frac{3}{4}$ "	tk 25289-22
----------------------------	--------------------

1:2

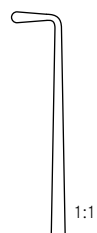
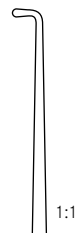

CUSHING

190 mm - 7 $\frac{1}{2}$ "	tk 25301-19	tk 25302-19
280 mm - 11"	tk 25301-28	tk 25302-28

Nervenhaken | Crochets à nerfs
Nerve hooks | Ganchos para nervios
 Uncini per nervi

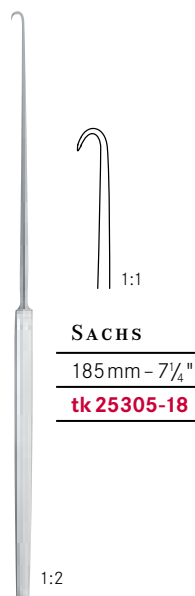

SACHS
 185 mm - 7 1/4"
tk 25305-18

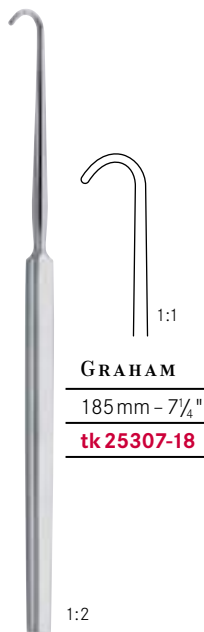

GRAHAM
 185 mm - 7 1/4"
tk 25307-18



FRAZIER
 170 mm - 6 3/4"
tk 25309-17

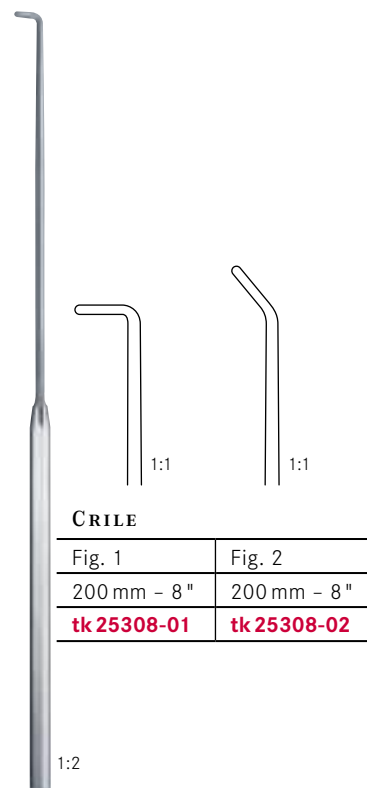

CRILE	
Fig. 1	Fig. 2
200 mm - 8"	200 mm - 8"
tk 25308-01	tk 25308-02



TOENNIS
 150 mm - 6"
tk 25310-15



DANDY
 200 mm - 8" **tk 25315-20**



tk 25316-20



tk 25317-20



ADSON
 200 mm - 8" **tk 25320-20** **tk 25321-20**

Nervenhaken
Nerve hooks

Crochets à nerfs
Ganchos para nervios
Uncini per nervi

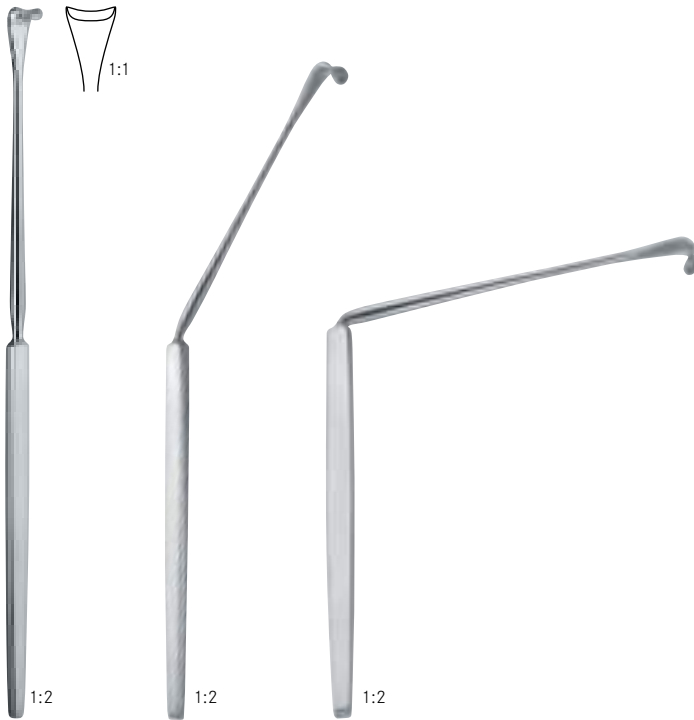

LOVE

190 mm - 7 1/2"	tk 25325-19	tk 25326-19	tk 25327-19
-----------------	--------------------	--------------------	--------------------



YASARGIL

310 mm - 12 1/4"	tk 25399-01
410 mm - 16 1/4"	tk 25399-02

Galeahaken
Galea retractor

Retracteur Galea
Retractor de Galea
Retratore di Galea

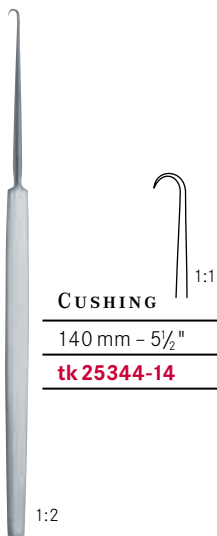

CUSHING

140 mm - 5 1/2"
tk 25344-14

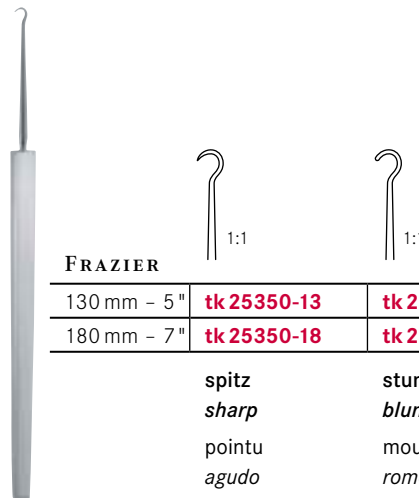

FRAZIER

130 mm - 5"	tk 25350-13	tk 25351-13
180 mm - 7"	tk 25350-18	tk 25351-18

spitz
sharp
pointu
agudo
acuto

stumpf
blunt
mousse
romos
smusso



LAHEY

130 mm - 5"
tk 25340-13

Mikro-Dissektoren | Micro dissecteurs
Micro dissectors | *Micro disectores*
 Mikro dissectori

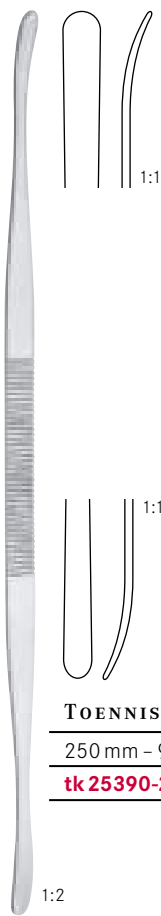

TOENNIS

250 mm - 9¾"

tk 25390-25

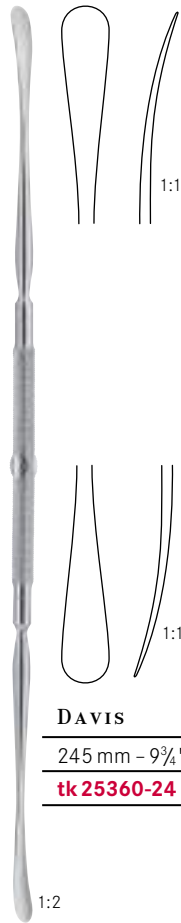

DAVIS

245 mm - 9¾"

tk 25360-24

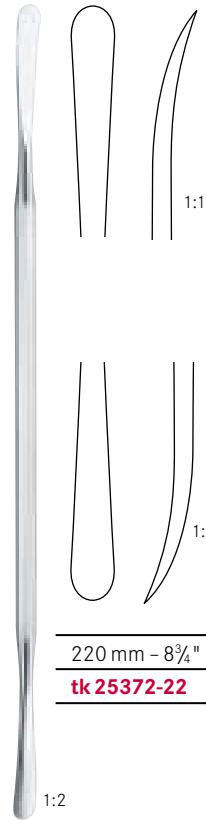

220 mm - 8¾"

tk 25372-22

Mikro-Dissektoren
Micro dissectors

Micro dissecteurs
Micro disectores
Micro dissectori

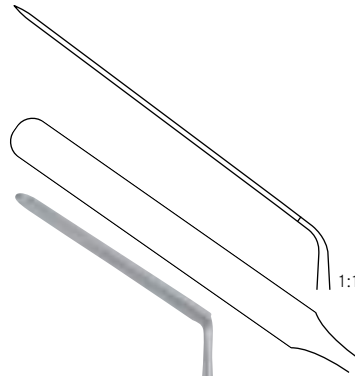

HORSLEY

200 mm - 8"

tk 25379-20

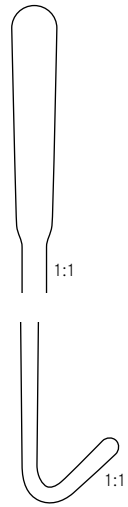

SMITHWICK

290 mm - 11½"

tk 25380-29



1:2

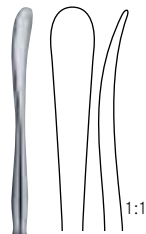

1:2



1:2

SACHS

210 mm - 8¼"

tk 25385-21

tk 25386-21

tk 25387-21

Mikro-Dissektoren | Micro dissecteurs
Micro dissectors | *Micro disectores*
 Mikro dissectori | Micro dissectori

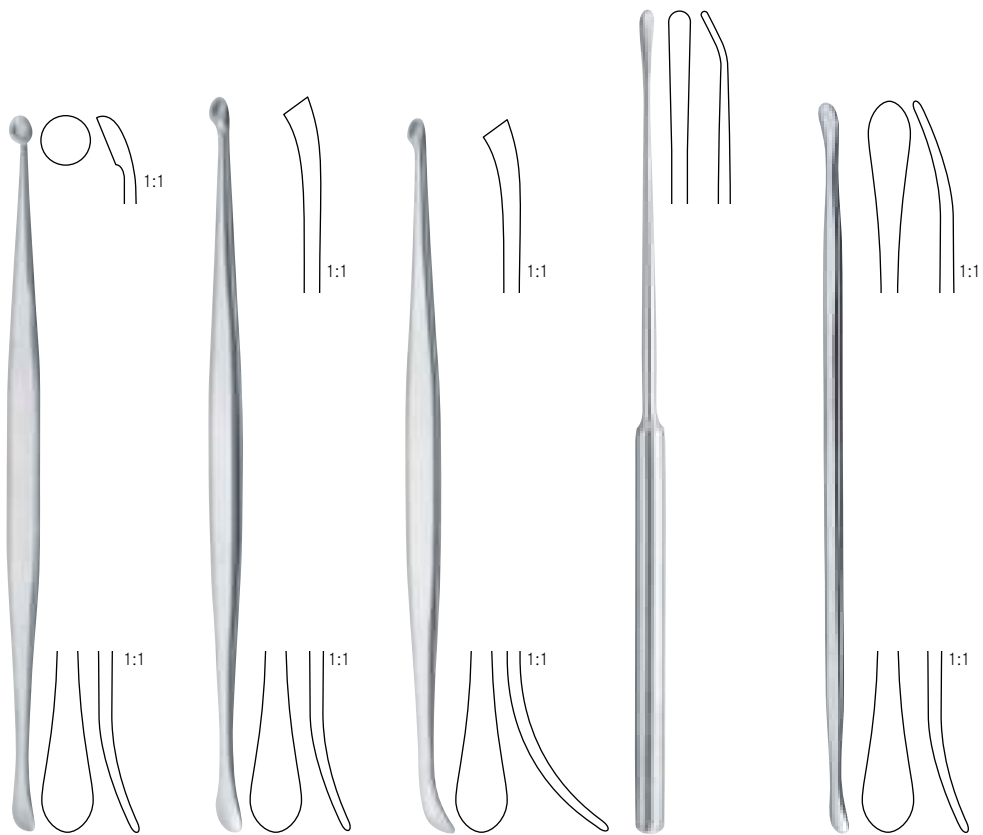

PENFIELD

Fig. 1	Fig. 2	Fig. 3	Fig. 4	Fig. 5
175 mm - 7"	195 mm - 7¾"	195 mm - 7¾"	215 mm - 8½"	185 mm - 7¼"
tk 25395-01	tk 25395-02	tk 25395-03	tk 25395-04	tk 25395-05

Neuro-Mikro-Dissektoren
Neuro-micro dissectors

Neuro-micro dissecteurs
Disectores para micro-neurocirugía
Strumento per micro-neuro chirurgia

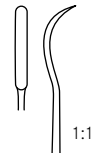

YASARGIL

190 mm - 7 1/2"	tk 25400-01	tk 25400-02	tk 25400-03	tk 25400-04	tk 25400-05
-----------------	--------------------	--------------------	--------------------	--------------------	--------------------

gerade
straight
droit
recta
rette

190 mm - 7 1/2"	tk 25401-01	tk 25401-02	tk 25401-03	tk 25401-04	tk 25401-05
-----------------	--------------------	--------------------	--------------------	--------------------	--------------------

bajonett
bayonet
baionette
bayoneta
baionetta

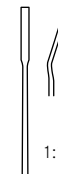
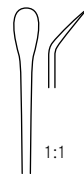

YASARGIL

190 mm - 7 1/2"	tk 25400-06	tk 25400-07	tk 25400-08	tk 25400-09
-----------------	--------------------	--------------------	--------------------	--------------------

gerade
straight
droit
recta
rette

190 mm - 7 1/2"	tk 25401-06	tk 25401-07	tk 25401-08	tk 25401-09
-----------------	--------------------	--------------------	--------------------	--------------------

bajonett
bayonet
baionette
bayoneta
baionetta



190 mm - 7 1/2"	tk 25400-10	tk 25400-11
-----------------	--------------------	--------------------

gerade, mit Dreh-Fixierhaken
straight, with Twist-fixationhook
droit, avec crochet de fixation
recta, con gancho de fijación
rette, con uncino di fissaggio „Twist“

Neuro-Mikro-Dissektoren
Neuro-micro dissectors

Neuro-micro dissecteurs
Disectores para micro-neurocirugía
 Strumento per micro-neuro chirurgia



1:1



1:1

KRAUS



1:1

YASARGIL



1:1

KOOS



1:1

KOOS



1:1

KOOS

190mm - 7½"	tk 25410-19	tk 25410-20	tk 25411-16	tk 25411-17	tk 25411-18
-------------	--------------------	--------------------	--------------------	--------------------	--------------------

bajonett
bayonet
 baionette
bayoneta
 baionetta

Neuro-Mikro-Dissektoren
Neuro-micro dissectors

Neuro-micro dissecteurs
Disectores para micro-neurocirugía
Strumento per micro-neuro chirurgia

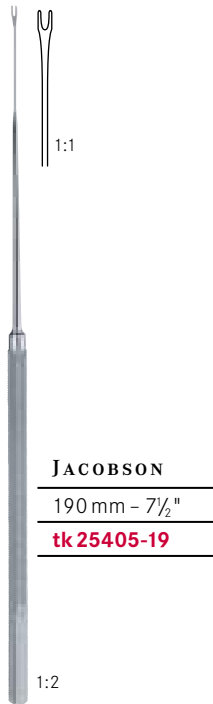

KRAYEN BÜHL	1:1	1:1	1:1	1:1
190 mm - 7 1/2"	tk 25407-01	tk 25407-02	tk 25407-03	tk 25407-04
	ohne Knopf <i>without knob</i> sans boule <i>sin bola</i> senza bottone		mit Knopf <i>with knob</i> avec boule <i>con bola</i> con bottone	



	1:1	JACOBSON	FISCH
190 mm - 7 1/2"	tk 25409-19	tk 25410-15	tk 25410-18

Neuro-Dissektoren und Küretten
Neuro-dissectors and curettes

Neuro-dissecteurs et curettes
Disectores y curetas para neurocirugía
 Scollatori per neuro-chirurgia



HARDY

250 mm - 9 3/4"	tk 25430-01	tk 25430-02	tk 25430-03	tk 25430-04
-----------------	-------------	-------------	-------------	-------------

bajonett, innen scharf
bayonet, sharp inner edge
 baionette, tranchant à l'interno
bayoneta, cortante al interno
 baionetta, acuto all'interno



HARDY

	4 mm Ø	6 mm Ø
270 mm - 10 3/4"	tk 25435-01	tk 25435-02

bajonett, biegsam
bayonet, malleable
 baionette, malléable
bayoneta, maleable
 baionetta, flessibile

Mikro-Federscheren
Micro scissors

Micro ciseaux à ressorts
Micro tijeras con resorte
Forbici per microchirurgia



1:1



1:1



1:1

VANNAS

80 mm - 3¼"

tk 9282-08

tk 9283-08

Vannas-Schneide

Vannas-blade

Lame de Vannas

Hoja de Vannas

Lama Vannas

Mikro-Federscheren
Micro-scissors

Micro ciseaux à ressorts
Micro tijeras con resorte
Forbici per microchirurgia

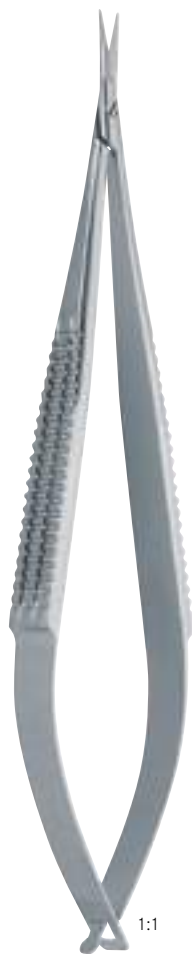

120 mm - 4 3/4"	tk 25753-01	tk 25753-02
Schneide 10 mm, spitz Blade 10 mm, sharp	gerade straight	gebogen curved
Lame 10 mm, pointu Hoja 10 mm, agudas Lama 10 mm, acuta	droite recta retta	courbe curva curva

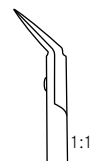
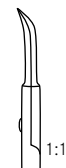
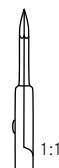

120 mm - 4 3/4"	tk 25753-03	tk 25753-04	tk 25753-05
Vannas-Schneide Vannas-blade	gerade straight	gebogen curved	aufgewinkelt angled up
Lama de Vannas Hoja de Vannas Vannas-lama	droite recta retta	courbe curva curva	angulaire acodada angolata

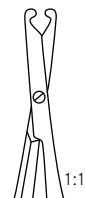

120 mm - 4 3/4"	tk 25753-06
Venen-Schneide (Biemer) Vein-blade (Biemer)	gerade straight
Lame pour vènes (Biemer) Hoja para venas (Biemer) Lama per vene (Biemer)	droite recta retta

Mikro-Federscheren
Micro-scissors

Micro ciseaux à ressorts
Micro tijeras con resorte
Forbici per microchirurgia

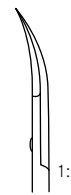
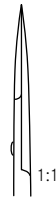
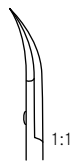
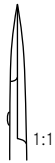

150 mm - 6"	tk 25670-15	tk 25671-15	tk 25672-15	tk 25673-15
	gerade, kurze Schneide <i>straight, short blades</i> droites, lames courtes <i>recta, hojas cortas</i> retta, lama corta	gebogen, kurze Schneide <i>curved, short blades</i> courbes, lames courtes <i>curva, hojas cortas</i> curva, lama corta	gerade, lange Schneide <i>straight, long blades</i> droites, lames longues <i>recta, hojas largas</i> retta, lama lunga	gebogen, lange Schneide <i>curved, long blades</i> courbes, lames longues <i>curva, hojas largas</i> curva, lama lunga

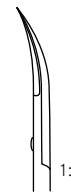
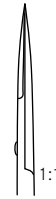

150 mm - 6"	tk 25678-15	tk 25679-15
	gerade, gezahnt <i>straight, saw edge</i> droites, dentelés <i>recta, dentadas</i> retta, dentata	gebogen, gezahnt <i>curved, saw edge</i> courbes, dentelés <i>curva, dentadas</i> curva, dentata

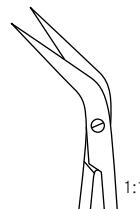

150 mm - 6"	tk 25675-15
180 mm - 7"	tk 25677-18

kniegebogen, 45°
angled on flat, 45°
angulaires, 45°
acodada, 45°
angolata, 45°

Mikro-Federscheren
Micro-scissors

Micro ciseaux à ressorts
Micro tijeras con resorte
Forbici per microchirurgia

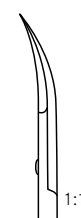
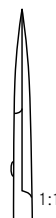

120 mm - 4 ³ / ₄ "	tk 25751-01	tk 25751-02
--	--------------------	--------------------

Lange Schneide 14 mm, glatt, spitz
Long blades 14 mm, smooth, sharp
Lames longues 14 mm, lisses, pointues
Hojas largas 14 mm, lisas, agudas
Lama lunga 14 mm, liscia, acuta

gerade
straight
droites
recta
retta

gebogen
curved
courbes
curva
curva

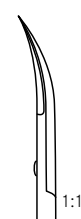

120 mm - 4 ³ / ₄ "	tk 25751-03	tk 25751-04
--	--------------------	--------------------

Lange Schneide 14 mm, spitz
Long blades 14 mm, sharp
Lames longues 14 mm, pointues
Hojas largas 14 mm, agudas
Lama lunga 14 mm, acuta

gerade, gezahnt
straight, saw edge
droites, dentelés
recta, dentadas
retta, dentata

gebogen, gezahnt
curved, saw edge
courbes, dentelés
curva, dentadas
curva, dentata

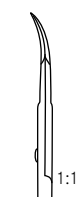
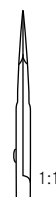

145 mm - 5 ³ / ₄ "	tk 25751-05	tk 25751-06
--	--------------------	--------------------

Vannas-Schneide, glatt, spitz
Vannas-blades, smooth, sharp
Lames de Vannas, lisses, pointues
Hojas de Vannas, lisas, agudas
Vannas-lama, liscia, acuta

gerade
straight
droits
recta
retta

gebogen
curved
courbes
curva
curva

Mikro-Federscheren
Micro-scissors

Micro ciseaux à ressorts
Micro tijeras con resorte
Forbici per microchirurgia

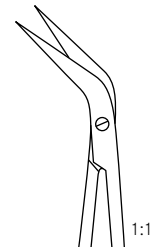
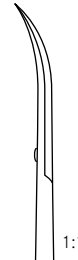
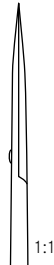

YASARGIL

185 mm - 7 ¹ / ₄ "	tk 25500-18	tk 25501-18	tk 25502-18
gerade <i>straight</i>	gebogen <i>curved</i>	kniegebogen <i>angled on flat</i>	
droits <i>recta</i>	courbes <i>curva</i>	angulaires <i>acodada</i>	
retta	curva	angolata	

Mikro-Federscheren
Micro scissors

Micro ciseaux
Micro tijeras
Forbici per micro chirurgia



1:1

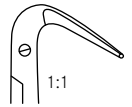
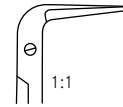
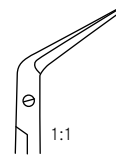
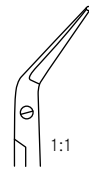

YASARGIL

	25°	45°	60°	90°	125°
170 mm - 6¾"	tk 25754-25	tk 25754-45	tk 25754-60	tk 25754-90	tk 25754-12

mit Knopf
with ball
avec bouton
con botón
con bottone

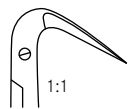
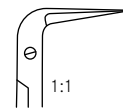
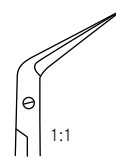
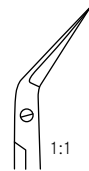

YASARGIL

	25°	45°	60°	90°	125°
170 mm - 6¾"	tk 25755-25	tk 25755-45	tk 25755-60	tk 25755-90	tk 25755-12

ohne Knopf
without ball
sans bouton
sin botón
senza bottone

Mikro-Präparierscheren
Micro dissecting scissors

 Micro ciseaux à dissection
Micro tijeras de disección

Forbici per micro chirurgia con manico rotondo

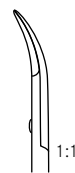
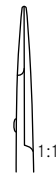
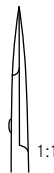

145 mm - 5 $\frac{3}{4}$ "	tk 25602-01	tk 25603-01	tk 25602-02	tk 25603-02
180 mm - 7"	tk 25610-01	tk 25611-01	tk 25610-02	tk 25611-02
kurze Schneide 8 mm, glatt <i>short blades 8 mm, smooth</i>	gerade, spitz <i>straight, sharp</i>	gebogen, spitz <i>curved, sharp</i>	gerade, stumpf <i>straight, blunt</i>	gebogen, stumpf <i>curved, blunt</i>
lames courtes 8 mm, lisses <i>hojas cortas 8 mm, lisos</i> lama corta 8 mm, liscia	droites, pointues <i>rectas, agudas</i> retta, acuta	courbes, pointues <i>curvas, agudas</i> curva, acuta	droites, mousses <i>rectas, romas</i> retta, smussa	courbes, mousses <i>curvas, romas</i> curva, smussa

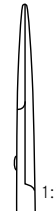
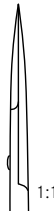

145 mm - 5 $\frac{3}{4}$ "	tk 25602-03	tk 25603-03	tk 25602-04	tk 25603-04
180 mm - 7"	tk 25610-03	tk 25611-03	tk 25610-04	tk 25611-04
lange Schneide 14 mm, glatt <i>long blades 14 mm, smooth</i>	gerade, spitz <i>straight, sharp</i>	gebogen, spitz <i>curved, sharp</i>	gerade, stumpf <i>straight, blunt</i>	gebogen, stumpf <i>curved, blunt</i>
lames longues 14 mm, lisses <i>hojas largas 14 mm, lisos</i> lama lunga 14 mm, liscia	droites, pointues <i>rectas, agudas</i> retta, acuta	courbes, pointues <i>curvas, agudas</i> curva, acuta	droites, mousses <i>rectas, romas</i> retta, smussa	courbes, mousses <i>curvas, romas</i> curva, smussa

Mikroscheren mit Rundgriff
 Micro scissors with round handle

Micro ciseaux avec manche ronde
 Micro tijeras con mango redondo
 Forbici per micro chirurgia con manico rotondo

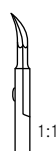
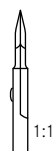

VANNAS

	7 mm Ø	7 mm Ø
120 mm - 5"	tk 25612-12	tk 25613-12

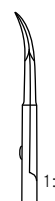
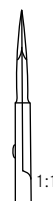

VANNAS

	8 mm Ø	8 mm Ø
150 mm - 6"	tk 25600-15	tk 25601-15



CASTROVIEJO

	8 mm Ø	8 mm Ø
150 mm - 6"	tk 25610-15	tk 25611-15

Mikroscheren mit Rundgriff
Micro scissors with round handle

Micro ciseaux avec manche ronde
Micro tijeras con mango redondo

Forbici per micro chirurgia con manico rotondo

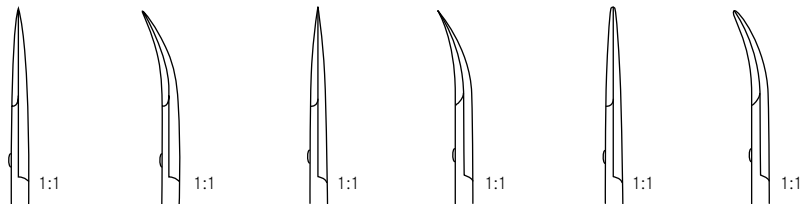

	180 mm - 7"	180 mm - 7"	180 mm - 7"	180 mm - 7"	180 mm - 7"	180 mm - 7"
8 mm Ø	tk 25606-18	tk 25607-18				
10 mm Ø	tk 25602-18	tk 25603-18	tk 25618-18	tk 25619-18	tk 25620-18	tk 25621-18

Mikroscheren mit Rundgriff
Micro scissors with round handle

Micro ciseaux avec manche ronde
Micro tijeras con mango redondo
 Forbici per micro chirurgia con manico rotondo



1:1

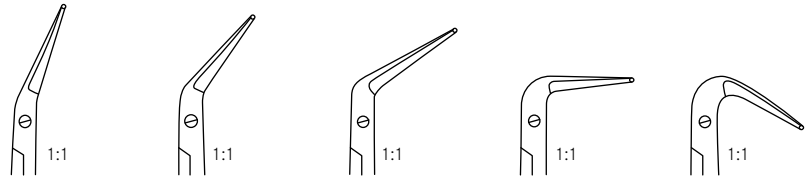

8 mm Ø	25°	45°	60°	90°	125°
180 mm - 7"	tk 25758-25	tk 25758-45	tk 25758-60	tk 25758-90	tk 25758-12

Schneide 10 mm, mit Knopf, spitz
Blade 10 mm, with ball, sharp

Lames 10 mm, avec bouton, pointues
Hojas 10 mm, con botón, agudas
 Lama 10 mm, con bottone, acuta

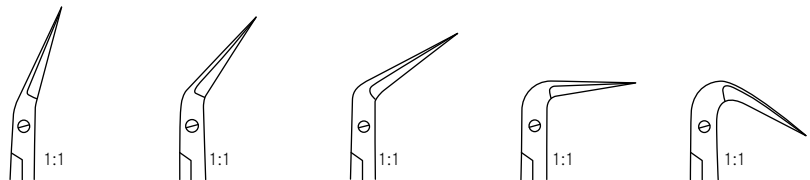

8 mm Ø	25°	45°	60°	90°	125°
180 mm - 7"	tk 25759-25	tk 25759-45	tk 25759-60	tk 25759-90	tk 25759-12

Schneide 10 mm, ohne Knopf, spitz
Blade 10 mm, without ball, sharp

Lames 10 mm, sans bouton, pointues
Hojas 10 mm, sin botón, agudas
 Lama 10 mm, senza bottone, acuta



mit gedrehtem Schluss
90° twisted
 tordus de 90°
giradas de 90°
 girato 90°

Mikroscheren mit Rundgriff
Micro scissors with round handle

Micro ciseaux avec manche ronde
Micro tijeras con mango redondo
 Forbici per micro chirurgia con manico rotondo

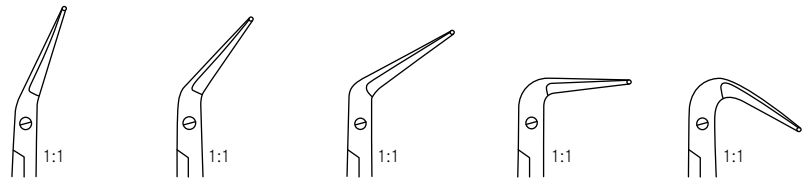

8 mm Ø	25°	45°	60°	90°	125°
180 mm - 7"	tk 25756-25	tk 25756-45	tk 25756-60	tk 25756-90	tk 25756-12

mit Knopf
with ball
 avec bouton
con botón
 con bottone

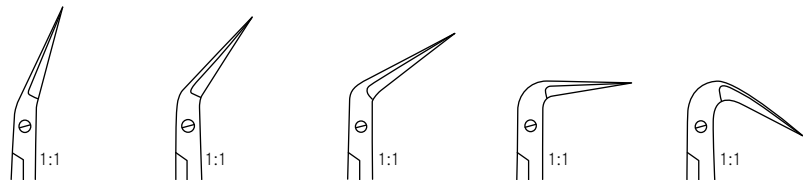

8 mm Ø	25°	45°	60°	90°	125°
180 mm - 7"	tk 25757-25	tk 25757-45	tk 25757-60	tk 25757-90	tk 25757-12

ohne Knopf
without ball
 sans bouton
sin botón
 senza bottone

Mikroscheren mit Rundgriff
Micro scissors with round handle

Micro ciseaux avec manche ronde
Micro tijeras con mango redondo
Forbici per micro chirurgia con manico rotondo



	9 mm Ø	9 mm Ø
150 mm - 6"	tk 25680-15	tk 25681-15

Mikro-Federscheren
Micro scissors

Micro ciseaux à ressorts
Micro tijeras con resorte
Forbici per microchirurgia

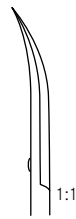
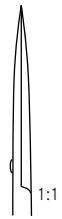

JACOBSON

160 mm - 6 1/4"	tk 25521-16	tk 25522-16	tk 25520-16
180 mm - 7"	tk 25521-18	tk 25522-18	tk 25520-18
gerade <i>straight</i>	gebogen <i>curved</i>	abgewinkelt, 45° <i>angled, 45°</i>	
droits <i>recta</i>	courbes <i>curva</i>	angulaires, 45° <i>acodada, 45°</i>	
retta	curva	angolata, 45°	

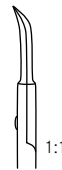
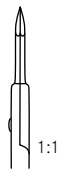

160 mm - 6 1/4"	tk 25526-16	tk 25527-16
180 mm - 7"	tk 25526-18	tk 25527-18

Vannas Schneide

Vannas blade

Lame de Vannas

Hoja de Vannas

Lama Vannas

Mikro-Federscheren
Micro scissors

Micro ciseaux à ressorts
Micro tijeras con resorte
Forbici per microchirurgia

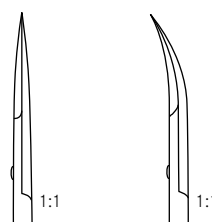

YASARGIL-
MOD.

180 mm - 7"	tk 25556-18	tk 25557-18
225 mm - 8¾"	tk 25556-22	tk 25557-22

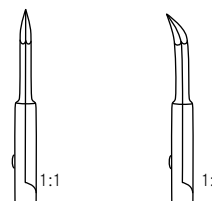

220 mm - 8¾"	tk 25558-22	tk 25559-22
--------------	--------------------	--------------------

Vannas Schneide
Vannas blade

Lame de Vannas
Hoja de Vannas
Lama Vannas

Mikro-Federscheren
Micro scissors

Micro ciseaux à ressorts
Micro tijeras con resorte
Forbici per microchirurgia

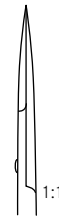
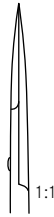

200 mm - 8"	tk 25760-01	tk 25760-02	tk 25760-03	tk 25760-04
225 mm - 8¾"	tk 25761-01	tk 25761-02	tk 25761-03	tk 25761-04
Schneide glatt, spitz <i>Blade smooth, sharp</i>	gerade <i>straight</i>	gebogen <i>curved</i>	gerade, gezahnt <i>straight, saw edge</i>	gebogen, gezahnt <i>curved, saw edge</i>
Lames lisses, pointues <i>Hojas lisas, agudas</i> Lama liscia, acuta	droits <i>recta</i> retta	courbes <i>curva</i> curva	droits, dentelées <i>recta, dentadas</i> retta, dentata	courbes, dentelées <i>curva, dentadas</i> curva, dentata

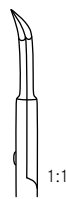
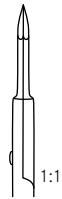

200 mm - 8"	tk 25760-05	tk 25760-06
225 mm - 8¾"	tk 25761-05	tk 25761-06

Vannas Schneide
Vannas blade

Lame de Vannas
Hoja de Vannas
Lama Vannas

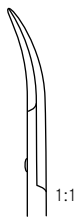
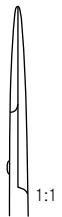

200 mm - 8"	tk 25760-07	tk 25760-08
225 mm - 8¾"	tk 25761-07	tk 25761-08

Präparier-Schneide, stumpf
Dissector blade, blunt

Lames de dissection, moussé
Hojas de disección, roma
Lama da dissezione, smussa

Fixierpinzetten – Gefäßdilatoren
Fixation forceps – Vascular dilators

Pinces à fixation – Dilatateurs vasculaires
Pinzas de fixaciòn – Dilatadores vasculares
 Pinze di fissaggio – Pinze per allargare i vasi



TYP
 JUWELIER

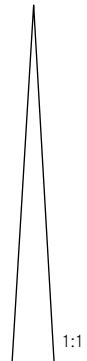
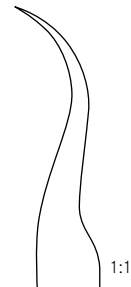
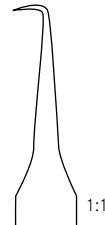
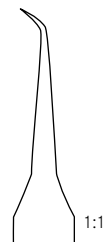
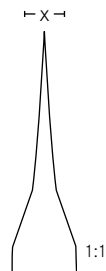

x = 0.2 mm	x = 0.3 mm	x = 0.3 mm	x = 0.2 mm	x = 0.3 mm
110 mm - 4 1/4"	110 mm - 4 1/4"	110 mm - 4 1/4"	120 mm - 4 3/4"	120 mm - 4 3/4"
tk 26001-11	tk 26002-11	tk 26003-11	tk 26005-12	tk 26006-13

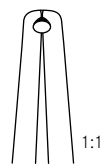

PIERSE

120 mm - 4 3/4"	tk 26009-12
135 mm - 5 1/4"	tk 26009-13

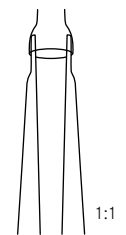
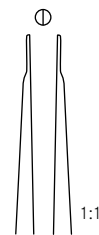

	x = 0.2 mm	x = 0.3 mm
110 mm - 4 1/4"	tk 26015-02	tk 26015-03

sehr fein
very fine
 très fin
muy fino
 molto fino

Mikro-Knüpfpinzetten
Micro suture tying forceps

Micro pinces pour sutures
Micro pinzas para suturas
Pinze per micro-suture

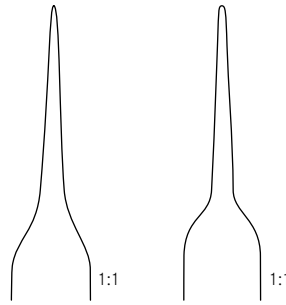

LAZAR

	0.5 mm	0.8 mm
155 mm - 6 "	tk 26016-01	tk 26016-02

Mikro-Knüpppinzetten
Micro suture tying forceps

Micro pinces pour sutures
Micro pinzas para suturas
Pinze per micro-sutura

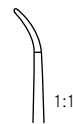

	9 mm Ø	9 mm Ø	9 mm Ø	9 mm Ø
180 mm - 7"	tk 25695-01	tk 25695-02	tk 25695-05	tk 25695-06

Fadenplatte 6,0 mm x 0,4 mm, glatt
Tying platform 6.0 mm x 0.4 mm, smooth
Plate-forme 6.0 mm x 0.4 mm, lisse
Plataforma 6.0 mm x 0.4 mm, lisa
Piano per sutura 6.0 mm x 0.4 mm, liscio

1x2 1x2

	9 mm Ø	9 mm Ø	9 mm Ø	9 mm Ø
180 mm - 7"	tk 25695-09	tk 25695-10	tk 25695-13	tk 25695-14

Fadenplatte 6,0 mm x 0,4 mm, diamantiert
Tying platform 6.0 mm x 0.4 mm, diamond coated
Plate-forme 6.0 mm x 0.4 mm, diamanté
Plataforma 6.0 mm x 0.4 mm, diamantada
Piano per sutura 6.0 mm x 0.4 mm, diamantata

1x2 1x2

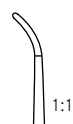

	9 mm Ø	9 mm Ø	9 mm Ø	9 mm Ø
180 mm - 7"	tk 25695-03	tk 25695-04	tk 25695-07	tk 25695-08

Fadenplatte 6,0 mm x 0,8 mm, glatt
Tying platform 6.0 mm x 0.8 mm, smooth
Plate-forme 6.0 mm x 0.8 mm, lisse
Plataforma 6.0 mm x 0.8 mm, lisa
Piano per sutura 6.0 mm x 0.8 mm, liscio

1x2 1x2

	9 mm Ø	9 mm Ø	9 mm Ø	9 mm Ø
180 mm - 7"	tk 25695-11	tk 25695-12	tk 25695-15	tk 25695-16

Fadenplatte 6,0 mm x 0,8 mm, diamantiert
Tying platform 6.0 mm x 0.8 mm, diamond coated
Plate-forme 6.0 mm x 0.8 mm, diamanté
Plataforma 6.0 mm x 0.8 mm, diamantada
Piano per sutura 6.0 mm x 0.8 mm, diamantata

1x2 1x2

Mikropinzetten
Micro forceps

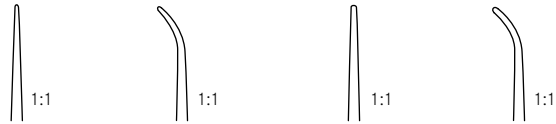
 Micro pincers
Micro pinzas
 Pinze per microchirurgia

8 mm Ø	0.3 mm	0.3 mm	0.7 mm	0.7 mm
150 mm – 6"	tk 25686-01	tk 25686-02	tk 25686-03	tk 25686-04
180 mm – 7"	tk 25687-01	tk 25687-02	tk 25687-03	tk 25687-04
210 mm – 8¼"	tk 25688-01	tk 25688-02	tk 25688-03	tk 25688-04
230 mm – 9"	tk 25689-01	tk 25689-02	tk 25689-03	tk 25689-04

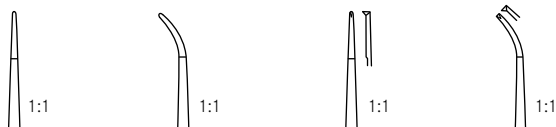
Maul glatt
Jaw smooth
 Mors lisse
Boca lisa
 Morso liscio

8 mm Ø	0.3 mm	0.3 mm	0.7 mm	0.7 mm
150 mm – 6"	tk 25686-05	tk 25686-06	tk 25686-09	tk 25686-10
180 mm – 7"	tk 25687-05	tk 25687-06	tk 25687-09	tk 25687-10
210 mm – 8¼"	tk 25688-05	tk 25688-06	tk 25688-09	tk 25688-10
230 mm – 9"	tk 25689-05	tk 25689-06	tk 25689-09	tk 25689-10

Fadenplatte 6,0 mm x 0,3 mm, glatt 1x2 1x2
Tying platform 6.0 mm x 0.3 mm, smooth
 Plate-forme 6.0 mm x 0.3 mm, lisse
Plataforma 6.0 mm x 0.3 mm, lisa
 Piano per sutura 6.0 mm x 0.3 mm, liscio



8 mm Ø	0.3 mm	0.3 mm	0.7 mm	0.7 mm
150 mm – 6"	tk 25686-07	tk 25686-08	tk 25686-11	tk 25686-12
180 mm – 7"	tk 25687-07	tk 25687-08	tk 25687-11	tk 25687-12
210 mm – 8¼"	tk 25688-07	tk 25688-08	tk 25688-11	tk 25688-12
230 mm – 9"	tk 25689-07	tk 25689-08	tk 25689-11	tk 25689-12

Fadenplatte 6,0 mm x 0,7 mm, glatt 1x2 1x2
Tying platform 6.0 mm x 0.7 mm, smooth
 Plate-forme 6.0 mm x 0.7 mm, lisse
Plataforma 6.0 mm x 0.7 mm, lisa
 Piano per sutura 6.0 mm x 0.7 mm, liscio

Mikropinzetten
Micro forceps

Micro pincers
Micro pinzas
Pinze per microchirurgia

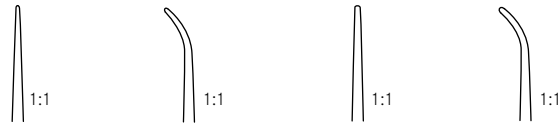
 diamantiert
diamond coated
diamanté
diamantada
diamantato



8 mm Ø	0.3 mm	0.3 mm	0.7 mm	0.7 mm
150 mm - 6"	tk 25686-13	tk 25686-14	tk 25686-15	tk 25686-16
180 mm - 7"	tk 25687-13	tk 25687-14	tk 25687-15	tk 25687-16
210 mm - 8 1/4"	tk 25688-13	tk 25688-14	tk 25688-15	tk 25688-16
230 mm - 9"	tk 25689-13	tk 25689-14	tk 25689-15	tk 25689-16

diamantiert
diamond coated
diamanté
diamantada
diamantata

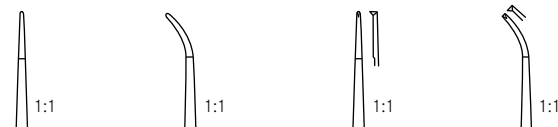

8 mm Ø	0.3 mm	0.3 mm	0.7 mm	0.7 mm
150 mm - 6"	tk 25686-17	tk 25686-18	tk 25686-21	tk 25686-22
180 mm - 7"	tk 25687-17	tk 25687-18	tk 25687-21	tk 25687-22
210 mm - 8 1/4"	tk 25688-17	tk 25688-18	tk 25688-21	tk 25688-22
230 mm - 9"	tk 25689-17	tk 25689-18	tk 25689-21	tk 25689-22

Fadenplatte 6,0 mm x 0,3 mm, diamantiert 1x2 1x2
 Tying platform 6.0 mm x 0.3 mm, diamond coated
 Plate-forme 6.0 mm x 0.3 mm, diamanté
 Plataforma 6.0 mm x 0.3 mm, diamantada
 Piano per sutura 6.0 mm x 0.3 mm, diamantata

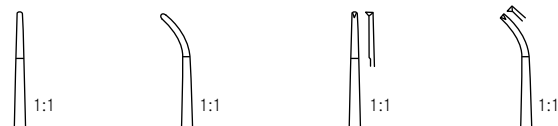

8 mm Ø	0.3 mm	0.3 mm	0.7 mm	0.7 mm
150 mm - 6"	tk 25686-19	tk 25686-20	tk 25686-23	tk 25686-24
180 mm - 7"	tk 25687-19	tk 25687-20	tk 25687-23	tk 25687-24
210 mm - 8 1/4"	tk 25688-19	tk 25688-20	tk 25688-23	tk 25688-24
230 mm - 9"	tk 25689-19	tk 25689-20	tk 25689-23	tk 25689-24

Fadenplatte 6,0 mm x 0,7 mm, diamantiert 1x2 1x2
 Tying platform 6.0 mm x 0.7 mm, diamond coated
 Plate-forme 6.0 mm x 0.7 mm, diamanté
 Plataforma 6.0 mm x 0.7 mm, diamantada
 Piano per sutura 6.0 mm x 0.7 mm, diamantata



Mikropinzetten
Micro forceps

 Micro pincers
Micro pinzas
 Pinze per microchirurgia

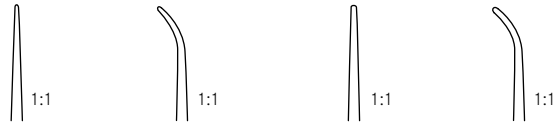
TITANTK

8 mm Ø	0.4 mm	0.4 mm	0.8 mm	0.8 mm
150 mm – 6"	tk 25786-01	tk 25786-02	tk 25786-03	tk 25786-04
180 mm – 7"	tk 25787-01	tk 25787-02	tk 25787-03	tk 25787-04
210 mm – 8¼"	tk 25788-01	tk 25788-02	tk 25788-03	tk 25788-04
230 mm – 9"	tk 25789-01	tk 25789-02	tk 25789-03	tk 25789-04

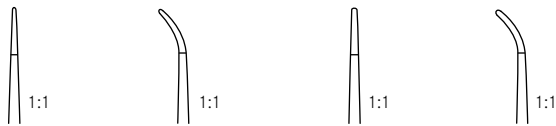
Maul glatt
Jaw smooth
 Mors lisse
Boca lisa
 Morso liscio

8 mm Ø	0.4 mm	0.4 mm	0.8 mm	0.8 mm
150 mm – 6"	tk 25786-05	tk 25786-06	tk 25786-07	tk 25786-08
180 mm – 7"	tk 25787-05	tk 25787-06	tk 25787-07	tk 25787-08
210 mm – 8¼"	tk 25788-05	tk 25788-06	tk 25788-07	tk 25788-08
230 mm – 9"	tk 25789-05	tk 25789-06	tk 25789-07	tk 25789-08

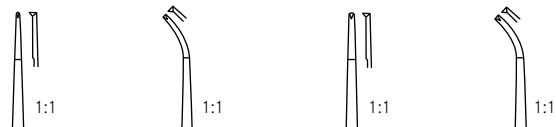
Fadenplatte 6,0 mm
Tying platform 6.0 mm
 Plate-forme 6.0 mm
Plataforma 6.0 mm
 Piano per sutura 6.0 mm

8 mm Ø	0.4 mm	0.4 mm	0.8 mm	0.8 mm
150 mm – 6"	tk 25786-09	tk 25786-10	tk 25786-11	tk 25786-12
180 mm – 7"	tk 25787-09	tk 25787-10	tk 25787-11	tk 25787-12
210 mm – 8¼"	tk 25788-09	tk 25788-10	tk 25788-11	tk 25788-12
230 mm – 9"	tk 25789-09	tk 25789-10	tk 25789-11	tk 25789-12

Fadenplatte 6,0 mm / 1x2 Zähne
Tying platform 6.0 mm / 1x2 teeth
 Plate-forme 6.0 mm / 1x2 dents
Plataforma 6.0 mm / 1x2 dientes
 Piano per sutura 6.0 mm / 1x2 denti

Mikropinzetten
Micro forceps

Micro pincers
Micro pinzas
Pinze per microchirurgia



diamantiert
diamond coated

diamanté
diamantada
diamantato

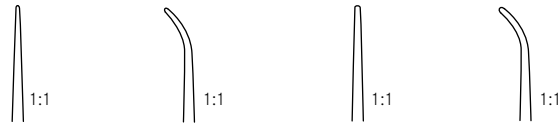

8 mm Ø	0.4 mm	0.4 mm	0.8 mm	0.8 mm
150 mm - 6"	tk 25786-13	tk 25786-14	tk 25786-15	tk 25786-16
180 mm - 7"	tk 25787-13	tk 25787-14	tk 25787-15	tk 25787-16
210 mm - 8 1/4"	tk 25788-13	tk 25788-14	tk 25788-15	tk 25788-16
230 mm - 9"	tk 25789-13	tk 25789-14	tk 25789-15	tk 25789-16

diamantiert
diamond coated

diamanté
diamantada
diamantata

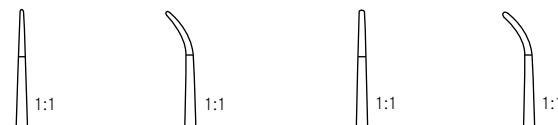

8 mm Ø	0.4 mm	0.4 mm	0.8 mm	0.8 mm
150 mm - 6"	tk 25786-17	tk 25786-18	tk 25786-19	tk 25786-20
180 mm - 7"	tk 25787-17	tk 25787-18	tk 25787-19	tk 25787-20
210 mm - 8 1/4"	tk 25788-17	tk 25788-18	tk 25788-19	tk 25788-20
230 mm - 9"	tk 25789-17	tk 25789-18	tk 25789-19	tk 25789-20

Fadenplatte 6,0mm, diamantiert
Tying platform 6.0mm, diamond coated

Plate-forme 6.0mm, diamanté
Plataforma 6.0mm, diamantada
Piano per sutura 6.0mm, diamantata

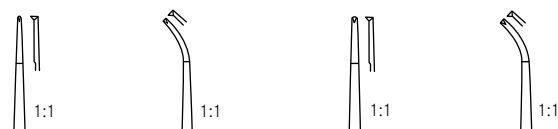

8 mm Ø	0.4 mm	0.4 mm	0.8 mm	0.8 mm
150 mm - 6"	tk 25786-21	tk 25786-22	tk 25786-23	tk 25786-24
180 mm - 7"	tk 25787-21	tk 25787-22	tk 25787-23	tk 25787-24
210 mm - 8 1/4"	tk 25788-21	tk 25788-22	tk 25788-23	tk 25788-24
230 mm - 9"	tk 25789-21	tk 25789-22	tk 25789-23	tk 25789-24

Fadenplatte 6,0mm / 1x2 Zähne, diamantiert
Tying platform 6.0mm / 1x2 teeth, diamond coated

Plate-forme 6.0mm / 1x2 dents, diamanté
Plataforma 6.0mm / 1x2 dientes, diamantada
Piano per sutura 6.0mm / 1x2 denti, diamantata



Mikropinzetten
Micro forceps

 Micro pincers
Micro pinzas
 Pinze per microchirurgia

JACOBSON

160 mm - 6 1/4"	tk 25733-01	tk 25733-02	tk 25733-03	tk 25733-04
180 mm - 7"	tk 25734-01	tk 25734-02	tk 25734-03	tk 25734-04
	gerade, spitz <i>straight, sharp</i>	gerade, stumpf <i>straight, blunt</i>	abgewinkelt, spitz <i>angled, sharp</i>	abgewinkelt, stumpf <i>angled, blunt</i>
	droit, pointue <i>recta, aguda</i>	droit, mousse <i>recta, roma</i>	angulaire, pointue <i>acodada, aguda</i>	angulaire, mousse <i>acodada, roma</i>
	retta, acuta	retta, smussa	angolata, acuta	angolata, smussa

160 mm - 6 1/4"	tk 25733-05	tk 25733-06	tk 25733-07	tk 25733-08
180 mm - 7"	tk 25734-05	tk 25734-06	tk 25734-07	tk 25734-08
diamantiert <i>diamond coated</i>	gerade, spitz <i>straight, sharp</i>	gerade, stumpf <i>straight, blunt</i>	abgewinkelt, spitz <i>angled, sharp</i>	abgewinkelt, stumpf <i>angled, blunt</i>
diamanté <i>diamantada</i>	droit, pointue <i>recta, aguda</i>	droit, mousse <i>recta, roma</i>	angulaire, pointue <i>acodada, aguda</i>	angulaire, mousse <i>acodada, roma</i>
diamantata	retta, acuta	retta, smussa	angolata, acuta	angolata, smussa

Mikropinzetten
Micro forceps

Micro pincers
Micro pinzas
 Pinze per microchirurgia

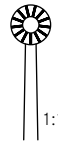
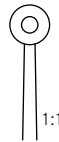

YASARGIL

	225 mm - 8¾"	225 mm - 8¾"	225 mm - 8¾"
3.0 mm	tk 25580-03	tk 25581-03	tk 25582-03
5.0 mm	tk 25580-05	tk 25581-05	tk 25582-05

löffelförmig
spoon form
 forme de cuillère
forma de cuchara
 forma di cucchiaio

flach gezahnt
plan toothed
 dentelé
dentada
 dentato

kürettenförmig
curette form
 forme de curette
forma de cureta
 forma di curetta

1:1

Mikropinzetten
Micro forceps

 Micro pincers
Micro pinzas
 Pinze per microchirurgia

1:1



200 mm – 8"	tk 25732-05	tk 25732-06	tk 25732-07	tk 25732-08
225 mm – 8¾"	tk 25732-13	tk 25732-14	tk 25732-15	tk 25732-16
diamantiert <i>diamond coated</i>	gerade, spitz <i>straight, sharp</i>	gerade, stumpf <i>straight, blunt</i>	abgewinkelt, spitz <i>angled, sharp</i>	abgewinkelt, stumpf <i>angled, blunt</i>
diamanté <i>diamantado</i>	droit, pointue <i>recta, aguda</i>	droit, mousse <i>recta, roma</i>	angulaire, pointue <i>acodada, aguda</i>	angulaire, mousse <i>acodada, roma</i>
diamantato	retta, acuta	retta, smussa	angolata, acuta	angolata, smussa

225 mm – 8¾"	tk 25876-22 Titan	tk 25877-22 Titan
TITAN	gerade, spitz <i>straight, sharp</i>	gerade, stumpf <i>straight, blunt</i>
	droit, pointue <i>recta, aguda</i>	droit, mousse <i>recta, roma</i>
	retta, acuta	retta, smussa

200 mm – 8"	tk 25732-03	tk 25732-04
225 mm – 8¾"	tk 25732-11	tk 25732-12
	abgewinkelt, spitz <i>angled, sharp</i>	abgewinkelt, stumpf <i>angled, blunt</i>
	angulaire, pointue <i>acodada, aguda</i>	angulaire, mousse <i>acodada, roma</i>
	angolata, acuta	angolata, smussa

Mikropinzetten mit Rundgriff
Micro-forceps with round handle

Micro-pince avec manche ronde
Pinzas micro con mango redondo
 Micro pinze con manico rotondo



	9 mm Ø	9 mm Ø	9 mm Ø	9 mm Ø
210 mm - 8 1/4"	tk 25730-01	tk 25730-02	tk 25730-03	tk 25730-04
230 mm - 9"	tk 25730-09	tk 25730-10	tk 25730-11	tk 25730-12
	gerade, spitz <i>straight, sharp</i>	gerade, stumpf <i>straight, blunt</i>	abgewinkelt, spitz <i>angled, sharp</i>	abgewinkelt, stumpf <i>angled, blunt</i>
	droit, pointue <i>recta, aguda</i>	droit, mousse <i>recta, roma</i>	angulaire, pointue <i>acodada, aguda</i>	angulaire, mousse <i>acodada, roma</i>
	retta, acuta	retta, smussa	angolata, acuta	angolata, smussa
	9 mm Ø	9 mm Ø	9 mm Ø	9 mm Ø
210 mm - 8 1/4"	tk 25730-05	tk 25730-06	tk 25730-07	tk 25730-08
230 mm - 9"	tk 25730-13	tk 25730-14	tk 25730-15	tk 25730-16
	diamantiert <i>diamond coated</i>	gerade, spitz <i>straight, sharp</i>	gerade, stumpf <i>straight, blunt</i>	abgewinkelt, spitz <i>angled, sharp</i>
	diamanté <i>diamantada</i>	droit, pointue <i>recta, aguda</i>	droit, mousse <i>recta, roma</i>	angulaire, pointue <i>acodada, aguda</i>
	diamantata	retta, acuta	retta, smussa	angolata, acuta
			angolata, acuta	angolata, smussa

Mikro-Ringpinzetten
Micro ring forceps

Micro pinces avec anneaux
Micro pinzas con anillos
Micro pinze con anelli



9 mm Ø	1.0x0.5 mm	1.0x0.5 mm	2.0x1.0 mm	2.0x1.0 mm	1.0x0.5 mm	2.0x1.0 mm
150 mm – 6"	tk 25698-01	tk 25698-02	tk 25698-03	tk 25698-04	tk 25698-05	tk 25698-06
180 mm – 7"	tk 25698-07	tk 25698-08	tk 25698-09	tk 25698-10	tk 25698-11	tk 25698-12
210 mm – 8¼"	tk 25699-01	tk 25699-02	tk 25699-03	tk 25699-04	tk 25699-05	tk 25699-06
230 mm – 9"	tk 25699-07	tk 25699-08	tk 25699-09	tk 25699-10	tk 25699-11	tk 25699-12

glatt <i>smooth</i>	fein gerieft <i>slightly serrated</i>	glatt <i>smooth</i>	fein gerieft <i>slightly serrated</i>	diamantiert <i>diamond coated</i>	diamantiert <i>diamond coated</i>
lisse <i>lisa</i>	légèrement strié <i>lig. estriada</i>	lisse <i>lisa</i>	légèrement strié <i>lig. estriada</i>	diamanté <i>diamantada</i>	diamanté <i>diamantada</i>
liscia	fina zigrinata	liscia	fina zigrinata	diamantata	diamantata



8 mm Ø	1.0x0.5 mm	1.0x0.5 mm	2.0x1.0 mm	2.0x1.0 mm	1.0x0.5 mm	2.0x1.0 mm
150 mm – 6"	tk 25696-01	tk 25696-02	tk 25696-03	tk 25696-04	tk 25696-05	tk 25696-06
180 mm – 7"	tk 25696-07	tk 25696-08	tk 25696-09	tk 25696-10	tk 25696-11	tk 25696-12
210 mm – 8¼"	tk 25697-01	tk 25697-02	tk 25697-03	tk 25697-04	tk 25697-05	tk 25697-06
230 mm – 9"	tk 25697-07	tk 25697-08	tk 25697-09	tk 25697-10	tk 25697-11	tk 25697-12

glatt <i>smooth</i>	fein gerieft <i>slightly serrated</i>	glatt <i>smooth</i>	fein gerieft <i>slightly serrated</i>	diamantiert <i>diamond coated</i>	diamantiert <i>diamond coated</i>
lisse <i>lisa</i>	légèrement strié <i>lig. estriada</i>	lisse <i>lisa</i>	légèrement strié <i>lig. estriada</i>	diamanté <i>diamantada</i>	diamanté <i>diamantada</i>
liscia	fina zigrinata	liscia	fina zigrinata	diamantata	diamantata

Mikro-Ringpinzetten
Micro ring forceps

Micro pinces avec anneaux
Micro pinzas con anillos
Micro pinze con anelli



9 mm Ø	1.0 mm x 0.5 mm	1.0 mm x 0.5 mm	2.0 mm x 1.0 mm	2.0 mm x 1.0 mm
210 mm - 8 1/4"	tk 25731-01	tk 25731-02	tk 25731-03	tk 25731-04
230 mm - 9"	tk 25731-07	tk 25731-08	tk 25731-09	tk 25731-10

glatt
smooth
lisse
liso
liscia

gerieft
serrated
strié
estriada
zigrinata

glatt
smooth
lisse
liso
liscia

gerieft
serrated
strié
estriada
zigrinata



9 mm Ø	1.0 mm x 0.5 mm	2.0 mm x 1.0 mm
210 mm - 8 1/4"	tk 25731-05	tk 25731-06
230 mm - 9"	tk 25731-11	tk 25731-12

diamantiert
diamond coated
diamanté
diamantada
diamantata

Atraumatische Mikropinzetten
Atraumatic micro forceps

Micro pinces atraumatiques
Micro pinces atraumaticas
Micro pinze atraumatiche

ATRAUM **TK**

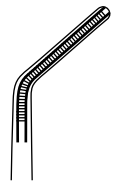
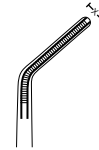
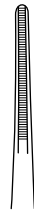
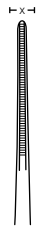

	x = 1.2 mm	x = 2.0 mm	x = 1.5 mm	x = 2.0 mm
150 mm - 6 "	tk 25690-01	tk 25690-02	tk 25690-03	tk 25690-04
180 mm - 7 "	tk 25690-05	tk 25690-06	tk 25690-07	tk 25690-08
210 mm - 8 1/4 "	tk 25690-09	tk 25690-10	tk 25690-11	tk 25690-12
230 mm - 9 "	tk 25690-13	tk 25690-14	tk 25690-15	tk 25690-16

gerade
straight

droit

recta

retta

gerade
straight

droit

recta

retta

abgewinkelt
angled

angulaire

acodada

angolata

abgewinkelt
angled

angulaire

acodada

angolata

Mikronadelhalter
Micro needle holders

Micro porte aiguilles
Micro porta agujas
Micro porta aghi



CASTROVIEJO

x = 11.0 mm x 0.75 mm

140 mm - 5½"

tk40910-14

tk40911-14

tk40912-14

tk40913-14

ohne Sperre, feines Maul
without ratchet, fine jaws

gerade
straight

gebogen
curved

gerade, diamantiert
straight, diamond coated

gebogen, diamantiert
curved, diamond coated

sans crémaillère, mors fine

droit

courbe

droit, diamanté

courbe, diamanté

sin cremallera, boca fina

recta

curva

recta, diamantada

curva, diamantada

senza cremagliera, morso fino

retto

curvo

retto, diamantato

curvo, diamantato

x = 11.0 mm x 0.75 mm

140 mm - 5½"

tk40915-14

tk40917-14

tk40918-14

tk40919-14

mit Sperre, feines Maul
with ratchet, fine jaws

gerade
straight

gebogen
curved

gerade, diamantiert
straight, diamond coated

gebogen, diamantiert
curved, diamond coated

avec crémaillère, mors fine

droit

courbe

droit, diamanté

courbe, diamanté

con cremallera, boca fina

recta

curva

recta, diamantada

curva, diamantada

con cremagliera, morso fino

retto

curvo

retto, diamantato



curvo, diamantato





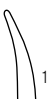

1:1

Mikronadelhalter
Micro needle holders

 Micro porte aiguilles
 Micro porta agujas
 Micro porta aghi

JACOBSON	 1:1	 1:1	 1:1	 1:1
	x = 1 mm	x = 1 mm	x = 1 mm	x = 1 mm
180 mm - 7"	tk 25740-01	tk 25740-02	tk 25740-13	tk 25740-14
ohne Sperre <i>without ratchet</i>	gerade <i>straight</i>	gebogen <i>curved</i>	gerade, diamantiert <i>straight, diamond coated</i>	gebogen, diamantiert <i>curved, diamond coated</i>
sans crémaillère <i>sin cremallera</i>	droit <i>recta</i>	courbe <i>curva</i>	droit, diamanté <i>recta, diamantada</i>	courbe, diamanté <i>curva, diamantada</i>
senza cremagliera	retto	curvo	retto, diamantato	curvo, diamantato
	x = 1 mm	x = 1 mm	x = 1 mm	x = 1 mm
180 mm - 7"	tk 25740-03	tk 25740-04	tk 25740-15	tk 25740-16
mit Sperre <i>with ratchet</i>	gerade <i>straight</i>	gebogen <i>curved</i>	gerade, diamantiert <i>straight, diamond coated</i>	gebogen, diamantiert <i>curved, diamond coated</i>
avec crémaillère <i>con cremallera</i>	droit <i>recta</i>	courbe <i>curva</i>	droit, diamanté <i>recta, diamantada</i>	courbe, diamanté <i>curva, diamantada</i>
con cremagliera	retto	curvo	retto, diamantato	curvo, diamantato



	 1:1	 1:1	 1:1	 1:1
	x = 1 mm	x = 1 mm	x = 1 mm	x = 1 mm
180 mm - 7"	tk 25740-05 tucar	tk 25740-06 tucar	tk 25740-09 tucar	tk 25740-10 tucar
ohne Sperre <i>without ratchet</i>	gerade, glatt <i>straight, smooth</i>	gebogen, glatt <i>curved, smooth</i>	gerade, gerieft <i>straight, serrated</i>	gebogen, gerieft <i>curved, serrated</i>
sans crémaillère <i>sin cremallera</i>	droit, lisse <i>recta, liso</i>	courbe, lisse <i>curva, lisa</i>	droit, strié <i>recta, estriada</i>	courbe, strié <i>curva, estriada</i>
senza cremagliera	retto, liscio	curvo, liscio	retto, zigrinato	curvo, zigrinato
	x = 1 mm	x = 1 mm	x = 1 mm	x = 1 mm
180 mm - 7"	tk 25740-07 tucar	tk 25740-08 tucar	tk 25740-11 tucar	tk 25740-12 tucar
mit Sperre <i>with ratchet</i>	gerade, glatt <i>straight, smooth</i>	gebogen, glatt <i>curved, smooth</i>	gerade, gerieft <i>straight, serrated</i>	gebogen, gerieft <i>curved, serrated</i>
avec crémaillère <i>con cremallera</i>	droit, lisse <i>recta, liso</i>	courbe, lisse <i>curva, lisa</i>	droit, strié <i>recta, estriada</i>	courbe, strié <i>curva, estriada</i>
con cremagliera	retto, liscio	curvo, liscio	retto, zigrinato	curvo, zigrinato

Mikronadelhalter
Micro needle holders

Micro porte aiguilles
Micro porta agujas
Micro porta aghi



YASARGIL

180 mm - 7"	tk 25512-18	tk 25513-18	tk 25514-18	tk 25515-18
200 mm - 8"	tk 25512-20	tk 25513-20	tk 25514-20	tk 25515-20
ohne Sperre <i>without ratchet</i>	gerade <i>straight</i>	gebogen <i>curved</i>	gerade, diamantiert <i>straight, diamond coated</i>	gebogen, diamantiert <i>curved, diamond coated</i>
sans crémaillère <i>sin cremallera</i>	droit <i>recta</i>	courbe <i>curva</i>	droit, diamanté <i>recta, diamantada</i>	courbe, diamanté <i>curva, diamantada</i>
senza cremagliera	retto	curvo	retto, diamantato	curvo, diamantato





180 mm - 7"	tk 25510-18	tk 25511-18	tk 25516-18	tk 25517-18
200 mm - 8"	tk 25510-20	tk 25511-20	tk 25516-20	tk 25517-20
mit Sperre <i>with ratchet</i>	gerade <i>straight</i>	gebogen <i>curved</i>	gerade, diamantiert <i>straight, diamond coated</i>	gebogen, diamantiert <i>curved, diamond coated</i>
avec crémaillère <i>con cremallera</i>	droit <i>recta</i>	courbe <i>curva</i>	droit, diamanté <i>recta, diamantada</i>	courbe, diamanté <i>curva, diamantada</i>
con cremagliera	retto	curvo	retto, diamantato	curvo, diamantato

Mikronadelhalter mit Rundgriff
Micro needle holders with round handle





Micro porte aiguilles avec manche ronde
Micro porta agujas con mango redondo
 Micro porta aghi con manico rotondo



1:1

YASARGIL	 1:1	 1:1	 1:1	 1:1
	x = 1 mm	x = 1 mm	x = 1 mm	x = 1 mm
210 mm - 8 1/4"	tk 25623-01	tk 25623-02	tk 25623-13	tk 25623-14
ohne Sperre <i>without ratchet</i>	gerade <i>straight</i>	gebogen <i>curved</i>	gerade, diamantiert <i>straight, diamond coated</i>	gebogen, diamantiert <i>curved, diamond coated</i>
sans crémaillère <i>sin cremallera</i>	droit <i>recta</i>	courbe <i>curva</i>	droit, diamanté <i>recta, diamantado</i>	courbe, diamanté <i>curva, diamantado</i>
senza cremagliera	retto <i>retto</i>	curvo <i>curvo</i>	retto, diamantato	curvo, diamantato
	x = 1 mm	x = 1 mm	x = 1 mm	x = 1 mm
210 mm - 8 1/4"	tk 25623-03	tk 25623-04	tk 25623-15	tk 25623-16
mit Sperre <i>with ratchet</i>	gerade <i>straight</i>	gebogen <i>curved</i>	gerade, diamantiert <i>straight, diamond coated</i>	gebogen, diamantiert <i>curved, diamond coated</i>
avec crémaillère <i>con cremallera</i>	droit <i>recta</i>	courbe <i>curva</i>	droit, diamanté <i>recta, diamantada</i>	courbe, diamanté <i>curva, diamantada</i>
con cremagliera	retto <i>retto</i>	curvo <i>curvo</i>	retto, diamantato	curvo, diamantato



	 1:1	 1:1	 1:1	 1:1
	x = 1 mm	x = 1 mm	x = 1 mm	x = 1 mm
210 mm - 8 1/4"	tk 25623-05 tucar	tk 25623-06 tucar	tk 25623-09 tucar	tk 25623-10 tucar
ohne Sperre <i>without ratchet</i>	gerade, glatt <i>straight, smooth</i>	gebogen, glatt <i>curved, smooth</i>	gerade, gerieft <i>straight, serrated</i>	gebogen, gerieft <i>curved, serrated</i>
sans crémaillère <i>sin cremallera</i>	droit, lisse <i>recta, lisa</i>	courbe, lisse <i>curva, lisa</i>	droit, strié <i>recta, estriada</i>	courbe, strié <i>curva, estriada</i>
senza cremagliera	retto, liscio	curvo, liscio	retto, zigrinato	curvo, zigrinato
	x = 1 mm	x = 1 mm	x = 1 mm	x = 1 mm
210 mm - 8 1/4"	tk 25623-07 tucar	tk 25623-08 tucar	tk 25623-11 tucar	tk 25623-12 tucar
mit Sperre <i>with ratchet</i>	gerade, glatt <i>straight, smooth</i>	gebogen, glatt <i>curved, smooth</i>	gerade, gerieft <i>straight, serrated</i>	gebogen, gerieft <i>curved, serrated</i>
avec crémaillère <i>con cremallera</i>	droit, lisse <i>recta, lisa</i>	courbe, lisse <i>curva, lisa</i>	droit, strié <i>recta, estriada</i>	courbe, strié <i>curva, estriada</i>
con cremagliera	retto, liscio	curvo, liscio	retto, zigrinato	curvo, zigrinato



Auf Anfrage mit kräftigem Maul 1.5 mm - 2.0 mm lieferbar.
On request also available with stronger jaw 1.5 mm - 2.0 mm.

Egalement disponible avec mors plus gros 1.5 mm - 2.0 mm.
También disponible con boca mas fuerte 1.5 mm - 2.0 mm.

A richiesta fornibile anche con morso più forte di mm 1.5 a mm 2.0.

Mikronadelhalter mit Rundgriff
Micro needle holders with round handle

Micro porte aiguilles avec manche ronde
Micro porta agujas con mango redondo
 Micro porta aghi con manico rotondo



110 mm - 4 1/4"	8 mm Ø	tk 25637-11	tk 25638-11
125 mm - 5"	7 mm Ø	tk 25654-12	tk 25655-12
130 mm - 5"	8 mm Ø	tk 25658-13	tk 25659-13
130 mm - 5"	10 mm Ø	tk 25652-13	tk 25653-13
150 mm - 6"	8 mm Ø	tk 25640-15	tk 25641-15
180 mm - 7"	8 mm Ø	tk 25664-18	tk 25665-18
180 mm - 7"	10 mm Ø	tk 25668-18	tk 25669-18





ohne Sperre <i>without ratchet</i>	gerade <i>straight</i>	gebogen <i>curved</i>
sans crémaillère <i>sin cremallera</i>	droit <i>recta</i>	courbe <i>curva</i>
senza cremagliera	retto	curvo

110 mm - 4 1/4"	8 mm Ø	tk 25635-11	tk 25636-11
125 mm - 5"	7 mm Ø	tk 25656-12	tk 25657-12
130 mm - 5"	8 mm Ø	tk 25662-13	tk 25663-13
130 mm - 5"	10 mm Ø	tk 25645-13	tk 25646-13
150 mm - 6"	8 mm Ø	tk 25642-15	tk 25643-15
180 mm - 7"	8 mm Ø	tk 25666-18	tk 25667-18
180 mm - 7"	10 mm Ø	tk 25670-18	tk 25671-18

mit Sperre <i>with ratchet</i>	gerade <i>straight</i>	gebogen <i>curved</i>
avec crémaillère <i>con cremallera</i>	droit <i>recta</i>	courbe <i>curva</i>
con cremagliera	retto	curvo

Mikronadelhalter mit Rundgriff
Micro needle holders with round handle

Micro porte aiguilles avec manche ronde
Micro porta agujas con mango redondo
 Micro porta aghi con manico rotondo

BARRAQUER		 1:1	 1:1	 1:1	 1:1
140 mm – 5½"	8 mm Ø	tk 25622-01	tk 25622-02	tk 25622-05	tk 25622-06
ohne Sperre, sehr feines Maul <i>without ratchet, extra delicate jaws</i>	gerade <i>straight</i>	gebogen <i>curved</i>	gerade, diamantiert <i>straight, diamond coated</i>	gebogen, diamantiert <i>curved, diamond coated</i>	
sans crémaillère, mors très fine <i>sin cremallera, boca muy fina</i>	droit <i>recta</i>	courbe <i>curva</i>	droit, diamanté <i>recta, diamantada</i>	courbe, diamanté <i>curva, diamantada</i>	
senza cremagliera, morso molto fino	retto	curvo	retto, diamantato	curvo, diamantato	
140 mm – 5½"	8 mm Ø	tk 25622-03	tk 25622-04	tk 25622-07	tk 25622-08
mit Sperre, sehr feines Maul <i>with ratchet, extra delicate jaws</i>	gerade <i>straight</i>	gebogen <i>curved</i>	gerade, diamantiert <i>straight, diamond coated</i>	gebogen, diamantiert <i>curved, diamond coated</i>	
avec crémaillère, mors très fine <i>con cremallera, boca muy fina</i>	droit <i>recta</i>	courbe <i>curva</i>	droit, diamanté <i>recta, diamantada</i>	courbe, diamanté <i>curva, diamantada</i>	
con cremagliera, morso molto fino	retto	curvo	retto, diamantato	curvo, diamantato	



Mikronadelhalter
Micro needle holders

Micro porte aiguilles
Micro porta agujas
Micro porta aghi



150 mm - 6" | 9 mm Ø

tk 25685-15

ohne Sperre, gebogen
without ratchet, curved
sans crémaillère, courbe
sin cremallera, curvo
senza cremagliera, curvo

1:1



Mikronadelhalter
Micro needle holders

Micro porte aiguilles
Micro porta agujas
Micro porta aghi



Das 2 in 1 System erlaubt die Benutzung der Nadelhalter, selbst während des Eingriffs, mit Sperre (Fig. A) oder ohne Sperre (Fig. B). Außer dem wirtschaftlichen Aspekt, der für dieses System spricht, erhöht sich auch die Zuverlässigkeit der Instrumente.

*The 2 in 1 system allows to switch intraoperatively from lock (Fig. A) to lock free (Fig. B) use of the needle holder.
In addition to cost effectiveness, this new concept provides better reliability.*

Le système 2 in 1 permet d'utiliser, même en cours d'intervention, les porte-aiguille avec verrou (Fig. A) ou sans verrou (Fig. B). En dehors de l'aspect économique, ce nouveau concept apporte une plus grande fiabilité.

*El sistema 2 in 1 permite utilizar el portaaguja con cerrojo (Fig. A) o sin cerrojo (Fig. B) incluso durante la intervención.
Aparte del aspecto económico, este nuevo concepto aporta una mayor fiabilidad.*

Il sistema 2 in 1 permette di utilizzare, anche in corso d'intervento il portaghi con la chiusura (Fig. A) o senza (Fig. B). Questo nuovo concetto assicura una maggiore affidabilità.

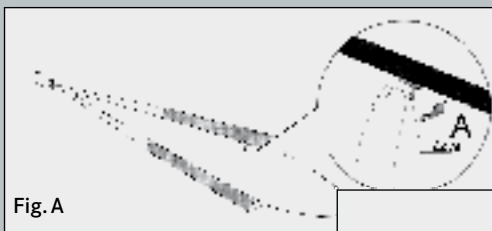

Fig. A

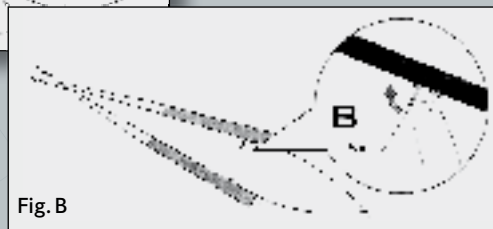
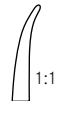

Fig. B

Mikronadelhalter
Micro needle holders

Micro porte aiguilles
Micro porta agujas
Micro porta aghi



	0.3 mm x 0.4 mm	0.3 mm x 0.4 mm
180 mm - 7"	tk 25685-07	tk 25685-08

Titan, mit Sperre
Titanium, with ratchet
Titane, avec crémaillère
Titano, con cremallera
Titanio, con cremagliera

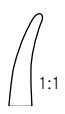

	0.8 mm x 0.8 mm	0.8 mm x 0.8 mm
185 mm - 7 1/4"	tk 25685-09	tk 25685-10

Titan, mit Sperre
Titanium, with ratchet
Titane, avec crémaillère
Titano, con cremallera
Titanio, con cremagliera

Mikronadelhalter
Micro needle holders

Micro porte aiguilles
Micro porta agujas
Micro porta aghi

TITANK



1:1



1:1



1:1



1:1

	0.5 mm x 0.8 mm	0.5 mm x 0.8 mm
200 mm - 8"	tk 25685-11	tk 25685-12

Titan, mit Sperre

Titanium, with ratchet

Titane, avec crémaillère

Titano, con cremallera

Titano, con cremagliera



1:1



1:1



1:1



1:1

	0.4 x 0.6 mm	0.4 x 0.6 mm	0.6 x 0.6 mm	0.6 x 0.6 mm
200 mm - 8"	tk 25685-13	tk 25685-14	tk 25685-19	tk 25685-16

Titan, mit Sperre

Titanium, with ratchet

Titane, avec crémaillère

Titano, con cremallera

Titano, con cremagliera

Mikronadelhalter
Micro needle holders

Micro porte aiguilles
Micro porta agujas
Micro porta aghi



225 mm - 8¾"	tk 25563-22	tk 25564-22
stainless steel		

225 mm - 8¾"	tk 25565-22	tk 25566-22
--------------	--------------------	--------------------



225 mm - 8¾"	tk 25863-22 Titan	tk 25864-22 Titan
--------------	--------------------------	--------------------------



ohne Sperre
without ratchet
sans crémaillère
sin cremallera
senza cremagliera

225 mm - 8¾"	tk 25567-22	tk 25568-22
stainless steel		

225 mm - 8¾"	tk 25569-22	tk 25570-22
--------------	--------------------	--------------------



mit Sperre
with ratchet
avec crémaillère
con cremallera
con cremagliera

Mikronadelhalter mit gedrehtem Schluss
Micro needle holders, 90° twisted

Micro porte aiguilles, tordus de 90°
Micro porta agujas, giradas de 90°
 Porta aghi per micro-neurochirurgia

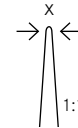
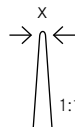

	x = 0.4 mm	x = 0.4 mm	x = 0.9 mm	x = 0.9 mm
200 mm - 8"	tk 25700-01	tk 25700-02	tk 25700-03	tk 25700-04
225 mm - 8¾"	tk 25700-09	tk 25700-10	tk 25700-11	tk 25700-12
240 mm - 9½"	tk 25702-01	tk 25702-02	tk 25702-03	tk 25702-04

ohne Sperre
without ratchet
 sans crémaillère
sin cremallera
 senza cremagliera

gerade
straight
 droit
recta
 retto

gebogen
curved
 courbe
curva
 curvo

gerade
straight
 droit
recta
 retto

gebogen
curved
 courbe
curva
 curvo

	x = 0.4 mm	x = 0.4 mm	x = 0.9 mm	x = 0.9 mm
200 mm - 8"	tk 25700-05	tk 25700-06	tk 25700-07	tk 25700-08
225 mm - 8¾"	tk 25700-13	tk 25700-14	tk 25700-15	tk 25700-16
240 mm - 9½"	tk 25702-05	tk 25702-06	tk 25702-07	tk 25702-08

ohne Sperre, diamantiert
without ratchet, diamond coated
 sans crémaillère, diamanté
sin cremallera, diamantada
 senza cremagliera, diamantato

gerade
straight
 droit
recta
 retto

gebogen
curved
 courbe
curva
 curvo

gerade
straight
 droit
recta
 retto

gebogen
curved
 courbe
curva
 curvo



Diese Nadelhalter sind auch mit Sperre erhältlich.
These needle holders are also available with ratchet.

Ces porte aiguilles sont également disponibles avec crémaillère.
Estas porta agujas son también disponibles con cremallera.
 Questi port'aghi sono fornibili anche con cremagliera.

Mikronadelhalter | Micro porte aiguilles
 Micro needle holders | Micro porta agujas
 Micro porta aghi



JACOBSON

180 mm - 7"	tk 25701-01	tk 25701-02	tk 25701-05	tk 25701-06
ohne Sperre <i>without ratchet</i>	gerade <i>straight</i>	gebogen <i>curved</i>	gerade, diamantiert <i>straight, diamond coated</i>	gebogen, diamantiert <i>curved, diamond coated</i>
sans crémaillère <i>sin cremallera</i>	droit <i>recta</i>	courbe <i>curva</i>	droit, diamanté <i>recta, diamantada</i>	courbe, diamanté <i>curva, diamantada</i>
senza cremagliera	retto	curvo	retto, diamantato	curvo, diamantato

180 mm - 7"	tk 25701-03	tk 25701-04	tk 25701-07	tk 25701-08
mit Sperre <i>with ratchet</i>	gerade <i>straight</i>	gebogen <i>curved</i>	gerade, diamantiert <i>straight, diamond coated</i>	gebogen, diamantiert <i>curved, diamond coated</i>
avec crémaillère <i>con cremallera</i>	droit <i>recta</i>	courbe <i>curva</i>	droit, diamanté <i>recta, diamantada</i>	courbe, diamanté <i>curva, diamantadao</i>
con cremagliera	retto	curvo	retto, diamantato	curvo, diamantato



Diese Nadelhalter sind auch mit Sperre erhältlich.
 These needle holders are also available with ratchet.

Ces porte aiguilles sont également disponibles avec crémaillère.
 Estas porta agujas son también disponibles con cremallera.
 Questi port'aghi son fornibili anche con cremagliera.

Mikronadelhalter
Micro needle holders

Micro porte aiguilles
Micro porta agujas
Micro porta aghi

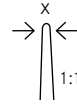
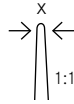

9 mm Ø	x = 1.0 mm	x = 1.0 mm	x = 1.0 mm	x = 1.0 mm
230 mm – 9"	tk 25624-01	tk 25624-02	tk 25624-13	tk 25624-14

ohne Sperre <i>without ratchet</i>	gerade <i>straight</i>	gebogen <i>curved</i>	gerade, diamantiert <i>straight, diamond coated</i>	gebogen, diamantiert <i>curved, diamond coated</i>
sans crémaillère <i>sin cremallera</i>	droit <i>recta</i>	courbe <i>curva</i>	droit, diamanté <i>recta, diamantada</i>	courbe, diamanté <i>curva, diamantada</i>
senza cremagliera	retto	curvo	retto, diamantato	curvo, diamantato

9 mm Ø	x = 1.0 mm	x = 1.0 mm	x = 1.0 mm	x = 1.0 mm
230 mm – 9"	tk 25624-03	tk 25624-04	tk 25624-15	tk 25624-16

mit Sperre <i>with ratchet</i>	gerade <i>straight</i>	gebogen <i>curved</i>	gerade, diamantiert <i>straight, diamond coated</i>	gebogen, diamantiert <i>curved, diamond coated</i>
avec crémaillère <i>con cremallera</i>	droit <i>recta</i>	courbe <i>curva</i>	droit, diamanté <i>recta, diamantada</i>	courbe, diamanté <i>curva, diamantada</i>
con cremagliera	retto	curvo	retto, diamantato	curvo, diamantato



9 mm Ø				
230 mm – 9"	tk 25624-05 tucark	tk 25624-06 tucark	tk 25624-09 tucark	tk 25624-10 tucark

ohne Sperre <i>without ratchet</i>	gerade, glatt <i>straight, smooth</i>	gebogen, glatt <i>curved, smooth</i>	gerade, gerieft <i>straight, serrated</i>	gebogen, gerieft <i>curved, serrated</i>
sans crémaillère <i>sin cremallera</i>	droit, lisse <i>recta, lisa</i>	courbe, lisse <i>curva, lisa</i>	droit, strié <i>recta, estriada</i>	courbe, strié <i>curva, estriada</i>
senza cremagliera	retto, liscio	curvo, liscio	retto, zigrinato	curvo, zigrinato



9 mm Ø				
230 mm – 9"	tk 25624-07 tucark	tk 25624-08 tucark	tk 25624-11 tucark	tk 25624-12 tucark

mit Sperre <i>with ratchet</i>	gerade, glatt <i>straight, smooth</i>	gebogen, glatt <i>curved, smooth</i>	gerade, gerieft <i>straight, serrated</i>	gebogen, gerieft <i>curved, serrated</i>
avec crémaillère <i>con cremallera</i>	droit, lisse <i>recta, lisa</i>	courbe, lisse <i>curva, lisa</i>	droit, strié <i>recta, estriada</i>	courbe, strié <i>curva, estriada</i>
con cremagliera	retto, liscio	curvo, liscio	retto, zigrinato	curvo, zigrinato

Laminektomiestanzen
Laminectomy punches

Pinces emporte-pièces à laminectomie
Pinzas cortantes para laminectomía
Pinze taglianti per laminectomia

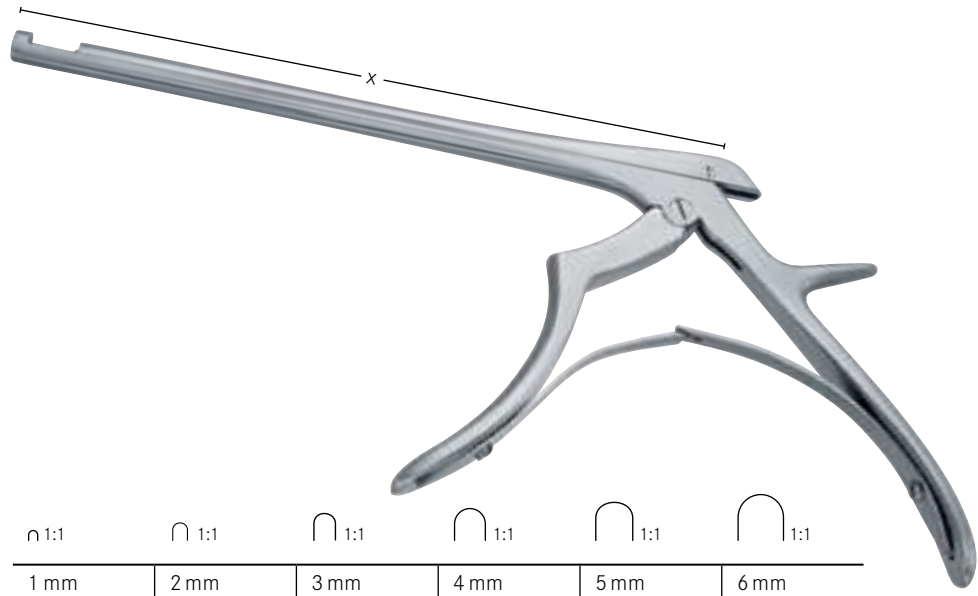

1 mm	2 mm	3 mm	4 mm	5 mm	6 mm
------	------	------	------	------	------

FERRIS- SMITH-KERRISON

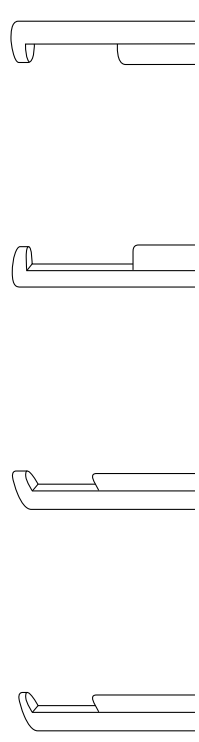

	x = 150mm - 6"	x = 180 mm - 7"	x = 200 mm - 8"	x = 230 mm - 9"
1 mm	tk 28001-01	tk 28002-01	tk 28003-01	tk 28004-01
2 mm	tk 28001-02	tk 28002-02	tk 28003-02	tk 28004-02
3 mm	tk 28001-03	tk 28002-03	tk 28003-03	tk 28004-03
4 mm	tk 28001-04	tk 28002-04	tk 28003-04	tk 28004-04
5 mm	tk 28001-05	tk 28002-05	tk 28003-05	tk 28004-05
6 mm	tk 28001-06	tk 28002-06	tk 28003-06	tk 28004-06
1 mm	tk 28005-01	tk 28006-01	tk 28007-01	tk 28008-01
2 mm	tk 28005-02	tk 28006-02	tk 28007-02	tk 28008-02
3 mm	tk 28005-03	tk 28006-03	tk 28007-03	tk 28008-03
4 mm	tk 28005-04	tk 28006-04	tk 28007-04	tk 28008-04
5 mm	tk 28005-05	tk 28006-05	tk 28007-05	tk 28008-05
6 mm	tk 28005-06	tk 28006-06	tk 28007-06	tk 28008-06
1 mm	tk 28010-01	tk 28011-01	tk 28012-01	tk 28013-01
2 mm	tk 28010-02	tk 28011-02	tk 28012-02	tk 28013-02
3 mm	tk 28010-03	tk 28011-03	tk 28012-03	tk 28013-03
4 mm	tk 28010-04	tk 28011-04	tk 28012-04	tk 28013-04
5 mm	tk 28010-05	tk 28011-05	tk 28012-05	tk 28013-05
6 mm	tk 28010-06	tk 28011-06	tk 28012-06	tk 28013-06
1 mm	tk 28089-01	tk 28090-01	tk 28094-01	
2 mm	tk 28089-02	tk 28090-02	tk 28094-02	tk 28095-02
3 mm		tk 28090-03	tk 28094-03	tk 28095-03
4 mm		tk 28090-04	tk 28094-04	tk 28095-04
5 mm		tk 28090-05	tk 28094-05	tk 28095-05
6 mm		tk 28090-06	tk 28094-06	tk 28095-06

Dünne Fußplatte
Thin footplate

Plaque de coupe étroite
Lámina de punzonar estrecha
Battente sottile

Zerlegbare Laminektomiestanzen
Dismantable laminectomy punches

Pinces emporte-pièces démontables à laminectomie
Pinzas cortantes desmontables para laminectomía
Pinze taglienti smontabili per laminectomia



∩ 1:1	∩ 1:1	∩ 1:1	∩ 1:1	∩ 1:1	∩ 1:1
1 mm	2 mm	3 mm	4 mm	5 mm	6 mm

FERRIS- SMITH-KERRISON

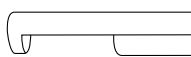

	x = 180 mm - 7"	x = 200 mm - 8"	x = 230 mm - 9"
1 mm	tk 28002-01Z	tk 28003-01Z	tk 28008-01Z
2 mm	tk 28002-02Z	tk 28003-02Z	tk 28008-02Z
3 mm	tk 28002-03Z	tk 28003-03Z	tk 28008-03Z
4 mm	tk 28002-04Z	tk 28003-04Z	tk 28008-04Z
5 mm	tk 28002-05Z	tk 28003-05Z	tk 28008-05Z
6 mm	tk 28002-06Z	tk 28003-06Z	tk 28008-06Z

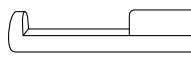

1 mm	tk 28006-01Z	tk 28007-01Z	tk 28009-01Z
2 mm	tk 28006-02Z	tk 28007-02Z	tk 28009-02Z
3 mm	tk 28006-03Z	tk 28007-03Z	tk 28009-03Z
4 mm	tk 28006-04Z	tk 28007-04Z	tk 28009-04Z
5 mm	tk 28006-05Z	tk 28007-05Z	tk 28009-05Z
6 mm	tk 28006-06Z	tk 28007-06Z	tk 28009-06Z

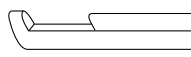

1 mm	tk 28011-01Z	tk 28013-01Z	tk 28015-01Z
2 mm	tk 28011-02Z	tk 28013-02Z	tk 28015-02Z
3 mm	tk 28011-03Z	tk 28013-03Z	tk 28015-03Z
4 mm	tk 28011-04Z	tk 28013-04Z	tk 28015-04Z
5 mm	tk 28011-05Z	tk 28013-05Z	tk 28015-05Z
6 mm	tk 28011-06Z	tk 28013-06Z	tk 28015-06Z



1 mm	tk 28090-01Z	tk 28091-01Z	tk 28095-01Z
2 mm	tk 28090-02Z	tk 28091-02Z	tk 28095-02Z
3 mm	tk 28090-03Z	tk 28091-03Z	tk 28095-03Z
4 mm	tk 28090-04Z	tk 28091-04Z	tk 28095-04Z
5 mm	tk 28090-05Z	tk 28091-05Z	tk 28095-05Z
6 mm	tk 28090-06Z	tk 28091-06Z	tk 28095-06Z

Dünne Fußplatte
Thin footplate

Plaque de coupe étroite
Lámina de punzonar estrecha
Battente sottile

Laminektomiestanzen
Laminectomy punches

Pinces emporte-pièces à laminectomie
Pinzas cortantes para laminectomía
Pinze taglianti per laminectomia

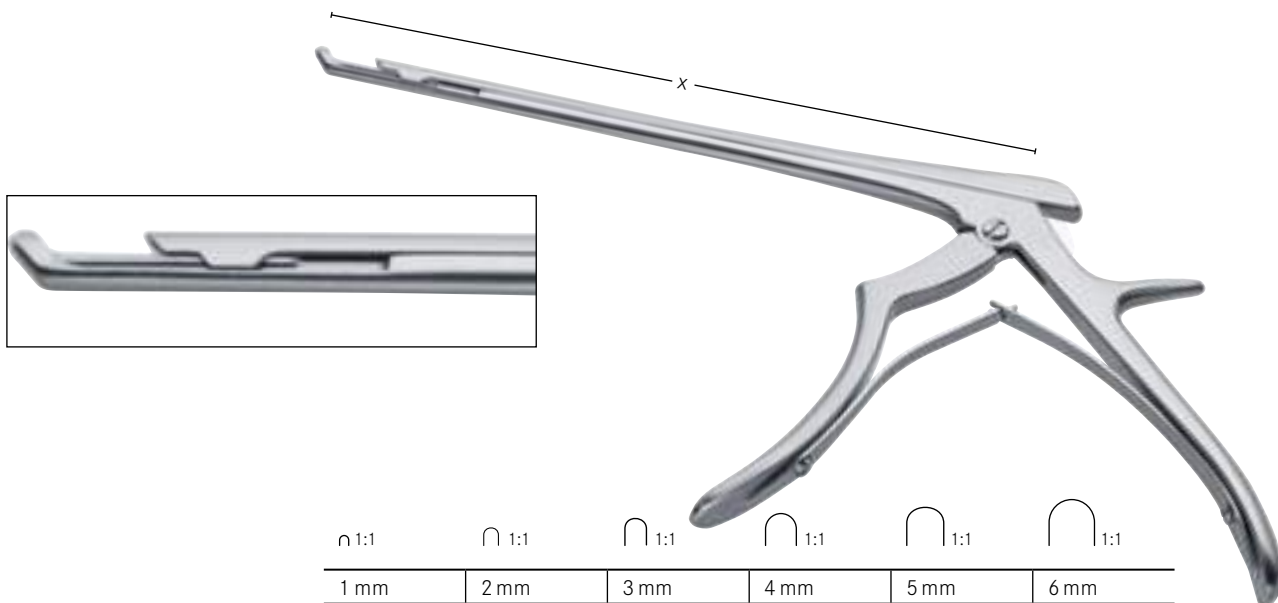

FERRIS- SMITH-KERRISON

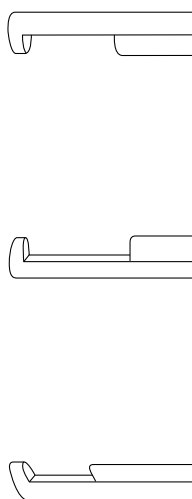

	x = 150mm - 6"	x = 180 mm - 7"	x = 200 mm - 8"	x = 230 mm - 9"
1 mm	tk 28001-01A	tk 28002-01A	tk 28003-01A	tk 28008-01A
2 mm	tk 28001-02A	tk 28002-02A	tk 28003-02A	tk 28008-02A
3 mm	tk 28001-03A	tk 28002-03A	tk 28003-03A	tk 28008-03A
4 mm	tk 28001-04A	tk 28002-04A	tk 28003-04A	tk 28008-04A
5 mm	tk 28001-05A	tk 28002-05A	tk 28003-05A	tk 28008-05A
6 mm	tk 28001-06A	tk 28002-06A	tk 28003-06A	tk 28008-06A
1 mm	tk 28005-01A	tk 28006-01A	tk 28007-01A	tk 28009-01A
2 mm	tk 28005-02A	tk 28006-02A	tk 28007-02A	tk 28009-02A
3 mm	tk 28005-03A	tk 28006-03A	tk 28007-03A	tk 28009-03A
4 mm	tk 28005-04A	tk 28006-04A	tk 28007-04A	tk 28009-04A
5 mm	tk 28005-05A	tk 28006-05A	tk 28007-05A	tk 28009-05A
6 mm	tk 28005-06A	tk 28006-06A	tk 28007-06A	tk 28009-06A
1 mm	tk 28010-01A	tk 28011-01A	tk 28013-01A	tk 28015-01A
2 mm	tk 28010-02A	tk 28011-02A	tk 28013-02A	tk 28015-02A
3 mm	tk 28010-03A	tk 28011-03A	tk 28013-03A	tk 28015-03A
4 mm	tk 28010-04A	tk 28011-04A	tk 28013-04A	tk 28015-04A
5 mm	tk 28010-05A	tk 28011-05A	tk 28013-05A	tk 28015-05A
6 mm	tk 28010-06A	tk 28011-06A	tk 28013-06A	tk 28015-06A

mit Auswerfer
with ejector

con expulsor
avec éjecteur
con espulsore



Auf Anfrage auch zerlegbar lieferbar.
On request also detachable available.

A petición también disponible desmontable.
Sue demande aussi disponible détachable.
A richiesta si fornisce anche smontabile.

Laminektomiestanzen
Laminectomy punches

Pinces emporte-pièces à laminectomie
Pinzas cortantes para laminectomía
Pinze taglienti per laminectomia

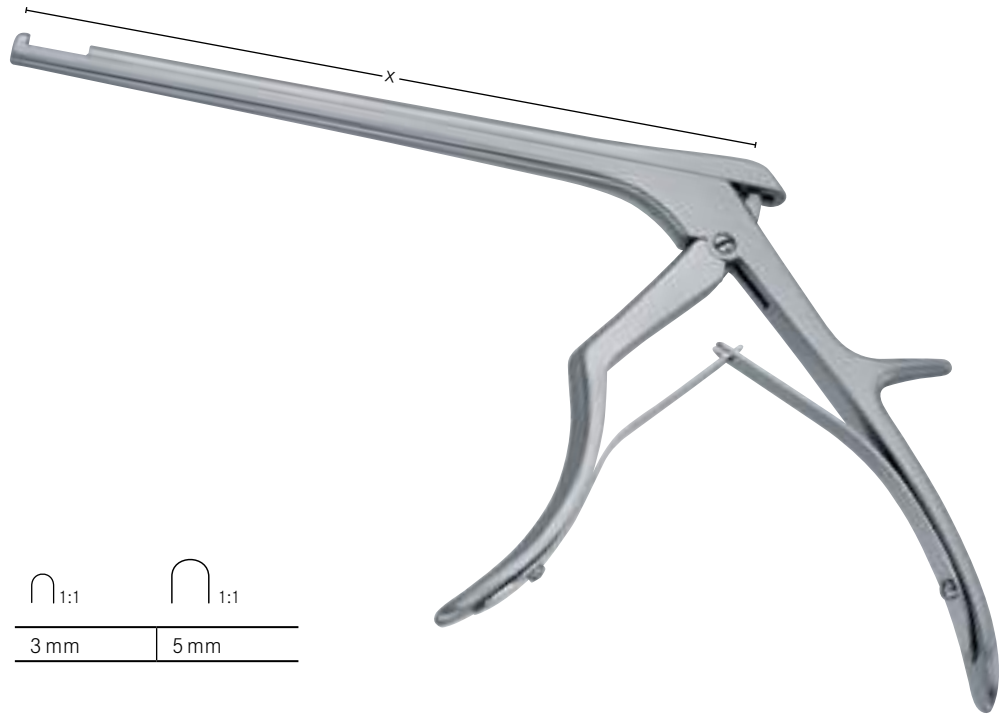

COLCLOUGH

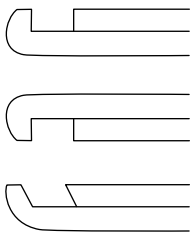

	x = 150 mm - 6"	x = 200 mm - 8"
3 mm	tk 28016-03	tk 28017-03
5 mm	tk 28016-05	tk 28017-05
3 mm	tk 28018-03	tk 28019-03
5 mm	tk 28018-05	tk 28019-05
3 mm	tk 28022-03	tk 28023-03
5 mm	tk 28022-05	tk 28023-05

Laminektomiestanzen
Laminectomy punches

Pinces emporte-pièces à laminectomie
Pinzas cortantes para laminectomía
Pinze taglianti per laminectomia



FERRIS-SMITH-KERRISON	
	x = 180mm - 7"
5 mm	tk 28024-01
5 mm	tk 28024-02

Laminektomiezanzen
Laminectomy rongeurs

Pinces emporte-pièces à laminectomie
Pinzas cortantes para laminectomía
Pinze taglianti per laminectomia

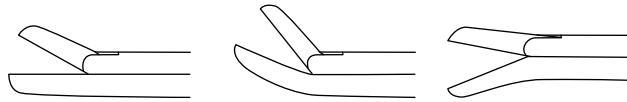

CUSHING

	2 mm x 10 mm	2 mm x 10 mm	2 mm x 10 mm
1:1 x = 130 mm - 5"	tk 28030-13	tk 28031-13	tk 28033-13
x = 150 mm - 6"	tk 28030-15	tk 28031-15	tk 28033-15
x = 180 mm - 7"	tk 28030-18	tk 28031-18	tk 28033-18
x = 220 mm - 8¾"	tk 28030-22	tk 28031-22	tk 28033-22

LOVE-GRUENWALD

	3 mm x 10 mm	3 mm x 10 mm	3 mm x 10 mm
1:1 x = 130 mm - 5"	tk 28034-13	tk 28035-13	tk 28037-13
x = 150 mm - 6"	tk 28034-15	tk 28035-15	tk 28037-15
x = 180 mm - 7"	tk 28034-18	tk 28035-18	tk 28037-18
x = 220 mm - 8¾"	tk 28034-22	tk 28035-22	tk 28037-22

SPURLING

	4 mm x 10 mm	4 mm x 10 mm	4 mm x 10 mm
1:1 x = 130 mm - 5"	tk 28038-13	tk 28039-13	tk 28041-13
x = 150 mm - 7"	tk 28038-15	tk 28039-15	tk 28041-15
x = 180 mm - 7"	tk 28038-18	tk 28039-18	tk 28041-18
x = 220 mm - 8¾"	tk 28038-22	tk 28039-22	tk 28041-22





CLOWARD

	6 mm x 10 mm		
1:1 x = 180 mm - 7"	tk 28042-18		

Laminektomieezangen
Laminectomy rongeurs

Pinces emporte-pièces à laminectomie
Pinzas cortantes para laminectomía
Pinze taglianti per laminectomia



	FERRIS-SMITH	x = 180 mm - 7"	x = 180 mm - 7"	x = 180 mm - 7"
 1:1	2 mm x 10 mm	tk 28050-02	tk 28051-02	tk 28053-02
 1:1	3 mm x 10 mm	tk 28050-03	tk 28051-03	tk 28053-03
 1:1	4 mm x 10 mm	tk 28050-04	tk 28051-04	tk 28053-04
 1:1	6 mm x 10 mm	tk 28050-06		



Andere Längen und Ausführungen sind auf Anfrage lieferbar.

Other lengths and executions are available upon request.

Autres longueurs et exécutions sont disponibles sur demande.



Otras longitudes y ejecuciones son disponibles según demanda.

Altre lunghezze e modelli fornibili a richiesta.

Laminektomiezangen
Laminectomy rongeurs

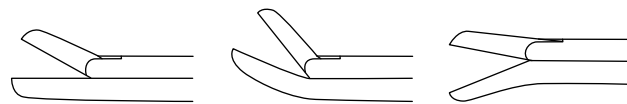
Pinces emporte-pièces à laminectomie
Pinzas cortantes para laminectomía
Pinze taglianti per laminectomia

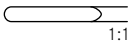
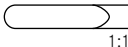
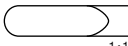

CASPAR		x = 155 mm - 6"	x = 155 mm - 6"	x = 155 mm - 6"
 1:1	2 mm	tk 28025-02	tk 28026-02	tk 28027-02
 1:1	3 mm	tk 28025-03	tk 28026-03	tk 28027-03
 1:1	4 mm	tk 28025-04	tk 28026-04	tk 28027-04
 1:1	5 mm	tk 28025-05		

Laminektomiezaugen
Laminectomy rongeurs

Pinces emporte-pièces à laminectomie
Pinzas cortantes para laminectomía
Pinze taglianti per laminectomia



OLDENBERG



x = 180 mm - 7"	3.5 mm Ø	6.0 mm Ø
170 mm - 6¾"	tk 28075-25	tk 28074-25



SCHLESINGER

	3 mm x 10 mm
	x = 125 mm - 5"
190 mm - 7½"	tk 28070-19

gezahnt
saw edge
dentelé
dentada
dentata

Laminektomiezangen
Laminectomy rongeurs

Pinces emporte-pièces à laminectomie
Pinzas cortantes para laminectomía
Pinze taglianti per laminectomia

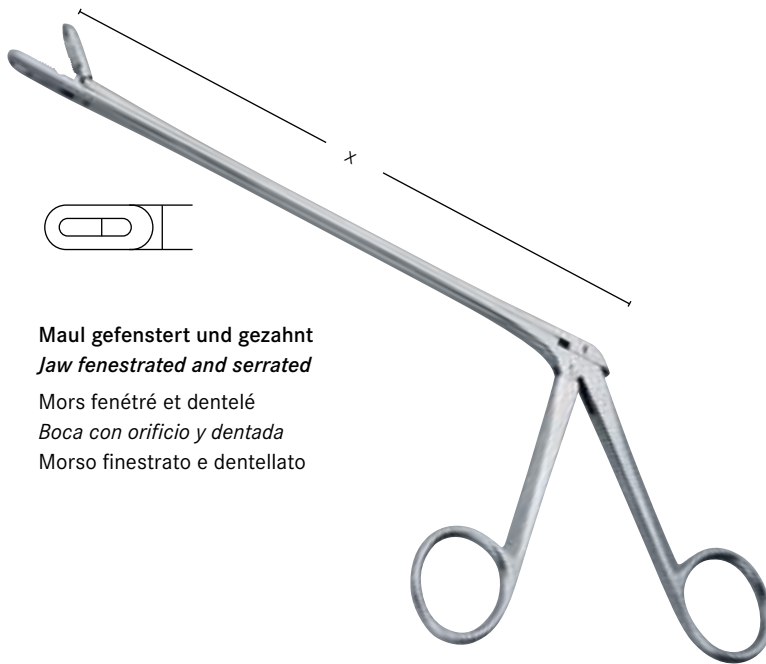

Maul gefenestert und gezahnt
Jaw fenestrated and serrated
Mors fenêtré et dentelé
Boca con orificio y dentada
Morso finestrato e dentellato



CASPAR

	x = 140 mm - 5½"	x = 160 mm - 6¼"	x = 185 mm - 7¼"
2 mm x 12 mm	tk 28080-02	tk 28081-02	tk 28082-02
3 mm x 12 mm	tk 28080-03	tk 28081-03	tk 28082-03
4 mm x 14 mm	tk 28080-04	tk 28081-04	tk 28082-04
5 mm x 14 mm		tk 28081-05	tk 28082-05
6 mm x 16 mm		tk 28081-06	tk 28082-06



	x = 140 mm - 5½"	x = 160 mm - 6¼"	x = 185 mm - 7¼"
3 mm x 12 mm	tk 28083-03	tk 28084-03	tk 28085-03
4 mm x 14 mm	tk 28083-04	tk 28084-04	tk 28085-04
5 mm x 14 mm		tk 28084-05	tk 28085-05



	x = 140 mm - 5½"	x = 160 mm - 6¼"	x = 185 mm - 7¼"
3 mm x 12 mm	tk 28086-03	tk 28087-03	tk 28088-03
4 mm x 14 mm	tk 28086-04	tk 28087-04	tk 28088-04

Laminektomiezen
Laminectomy rongeurs

Pinces emporte-pièces à laminectomie
Pinzas cortantes para laminectomía
Pinze taglianti per laminectomia

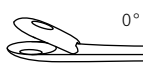

WEIL-
BLAKESLEY

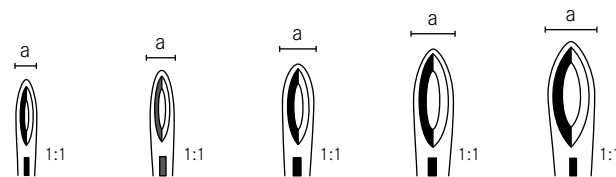

	Fig. 1	Fig. 2	Fig. 3	Fig. 4	Fig. 5
	a=3.0 mm	a=3.5 mm	a=4.5 mm	a=5.0 mm	a=5.5 mm
x = 120 mm - 4 3/4"	tk 51155-01	tk 51155-02	tk 51155-03	tk 51155-04	tk 51155-05

x = 120 mm - 4 3/4"	tk 51158-01	tk 51158-02	tk 51158-03	tk 51158-04	
---------------------	--------------------	--------------------	--------------------	--------------------	--

x = 120 mm - 4 3/4"	tk 51159-01	tk 51159-02	tk 51159-03		
---------------------	--------------------	--------------------	--------------------	--	--

	Fig. 1	Fig. 2	Fig. 3	Fig. 4	Fig. 5
	a=3.0 mm	a=3.5 mm	a=4.5 mm	a=5.0 mm	a=5.5 mm
x = 180 mm - 7"	tk 51160-01	tk 51160-02	tk 51160-03	tk 51160-04	tk 51160-05

x = 180 mm - 7"	tk 51161-01	tk 51161-02	tk 51161-03	tk 51161-04	
-----------------	--------------------	--------------------	--------------------	--------------------	--



Thorax, Lunge
Thorax, Lung

Thorax, Poumon
Tórax, Pulmón
 Torace, Polmone

Rippenscheren
Rib shears

Costotomes
Costótomos
Costotomi



Rippenscheren
Rib shears

Costotomes
Costótomos
Costotomi



1:3

LEBSCHÉ

245 mm - 9³/₄"

tk 24680-24



1:3

BRUNNER

320 mm - 12¹/₂"

tk 24681-32

für die rechte Hand
for the right hand

pour la main droite
para la mano derecha
per la mano destra



1:3

SAUERBRUCH-FREY

360 mm - 14¹/₄"

tk 24683-36

für die linke Hand
for the left hand

pour la main gauche
para la mano izquierda
per la mano sinistra

Rippenscheren
Rib shears

Costotomes
Costótomos
 Costotomi



1:3

SAUERBRUCH

260 mm - 10 $\frac{1}{4}$ " **tk 24685-26**



1:3

GIERTZ-STILLE

270 mm - 10 $\frac{3}{4}$ " **tk 24688-27**



1:3

BETHUNE

340 mm - 13 $\frac{1}{2}$ " **tk 24694-34**



Rippensperrer aus Aluminium *Rib spreaders made of aluminium*

Écarteurs de côtes en aluminium
Separadores costales en aluminio
Divaricatori costali in alluminio

Rippensperrer aus Aluminium zeichnen sich besonders durch ihre hohe mechanische Festigkeit aus. Aufgrund des geringen Gewichts sind Aluminium Instrumente für den Einsatz in der Kinder- und Neugeborenen-Chirurgie besonders geeignet. In der Erwachsenen-Chirurgie kommt es durch das geringere Gewicht der Aluminium-Instrumente ebenfalls zu einer erheblichen Entlastung des Operateurs und des Personals. Bei bildgebenden Verfahren, kommt es wegen der nicht-magnetischen Eigenschaft von Aluminium zu keinerlei Störungen. Aluminium ist bedingt durchlässig für Röntgenstrahlen und somit ebenfalls für die Orthopädie und Neurochirurgie geeignet.

Rib Spreaders made of aluminium present an outstanding mechanical resistance. Because of their low weight, aluminium instruments are perfectly suited for the children- and neonatal- surgery. Also in adult surgery, the low weight leads to considerable relief for the surgeon and the staff in the operation theatre. Imaging processes are also not disturbed, due to the non magnetic attribute of aluminium. As aluminium is partly translucent for X-rays, it is well suited for orthopedic and neurosurgical application.

Ecarteurs des côtes en aluminium se distinguent pour leur haute résistance mécanique. À cause de leur petit poids, des instruments en aluminium sont très convenients pour la chirurgie pédiatrique et des nouveaux-nés. Dans la chirurgie des adultes, le petit poids est un soulagement considérable du travail des chirurgiens et du personnel dans les bloc opératoires. Grâce à sa propriété anti-magnétique, l'aluminium n'a aucune influence négative sur des processus MRI (magnetic resonance imaging systems). Donc l'aluminium est partiellement perméable pour des rayons X, des instruments en aluminium sont bien utilisables pour des applications orthopédiques et neurocirurgicales.

Separadores costales en aluminio se distinguen especialmente por su alta resistencia mecánica. Por su poco peso, el instrumental en aluminio esta perfectamente apropiado para la cirugía de niños y neonatales. En la cirugía de adultos, el bajo peso implica también una facilitación considerable por el cirujano y el personal en el quirófano. Por su característica anti-magnética, el instrumental en aluminio no tiene ninguna influencia negativa sobre los procesos MRI (magnetic resonance imaging systems). La permeabilidad limitada del aluminio para los rayos X, permite el uso del instrumental en aluminio también para la orthopedia y neurocirugía.

Divaricatori costali Tekno in alluminio si distinguono per l'alta resistenza meccanica. Grazie al peso ridotto gli strumenti di alluminio sono perfetti per la chirurgia pediatrica e neonatale. Anche nella chirurgia tradizionale la leggerezza garantisce considerevoli vantaggi al chirurgo ed allo staff della camera operatoria. Essendo un metallo anti-magnetico l'alluminio è utilizzabile durante esami con risonanza magnetica (MRI). Grazie alla particolare permeabilità ai raggi X, gli strumenti di alluminio sono indicati per la neurochirurgia e per la chirurgia ortopedica.



Rippensperrer
Rib retractors

Ecarteurs des côtes
Separadores costales
Divaricatori costali

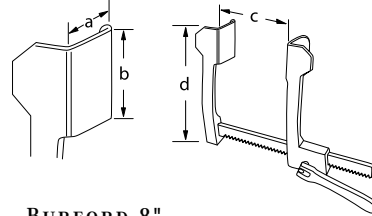

BURFORD 8"

	a	b	c	d
tk 24806-01	45 mm	62 mm	165 mm	200 mm
	65 mm	62 mm		

für Erwachsene, mit 2 Paar auswechselbaren Valven, Aluminium
for adults, with 2 pairs of interchangeable blades, aluminium
pour adultes, avec 2 paires de valves interchangeables, aluminium
para adultos, con 2 pares de valvas intercambiables, aluminio
per adulti, con 2 paia di valve intercambiabili, alluminio

BURFORD 10"

	a	b	c	d
tk 24806-02	45 mm	62 mm	250mm	200 mm
	65 mm	62 mm		

für Erwachsene, mit 2 Paar auswechselbaren Valven, Aluminium
for adults, with 2 pairs of interchangeable blades, aluminium
pour adultes, avec 2 paires de valves interchangeables, aluminium
para adultos, con 2 pares de valvas intercambiables, aluminio
per adulti, con 2 paia di valve intercambiabili, alluminio

BURFORD 12"

	a	b	c	d
tk 24806-03	45 mm	62 mm	290 mm	200 mm
	62 mm	62 mm		

für Erwachsene, mit 2 Paar auswechselbaren Valven, Aluminium
for adults, with 2 pairs of interchangeable blades, aluminium
pour adultes, avec 2 paires de valves interchangeables, aluminium
para adultos, con 2 pares de valvas intercambiables, aluminio
per adulti, con 2 paia di valve intercambiabili, alluminio

BURFORD

	a	b	c	d
tk 24806-05	34 mm	42 mm	135 mm	117 mm
	48 mm	42 mm		

für Kinder, mit 2 Paar auswechselbaren Valven, Aluminium
for children, with 2 pairs of interchangeable blades, aluminium
pour enfants, avec 2 paires de valves interchangeables, aluminium
para niños, con 2 pares de valvas intercambiables, aluminio
per bambini, con 2 paia di valve intercambiabili, alluminio

Rippensperrer
Rib retractors

Ecarteurs des côtes
Separadores costales
Divaricatori costali

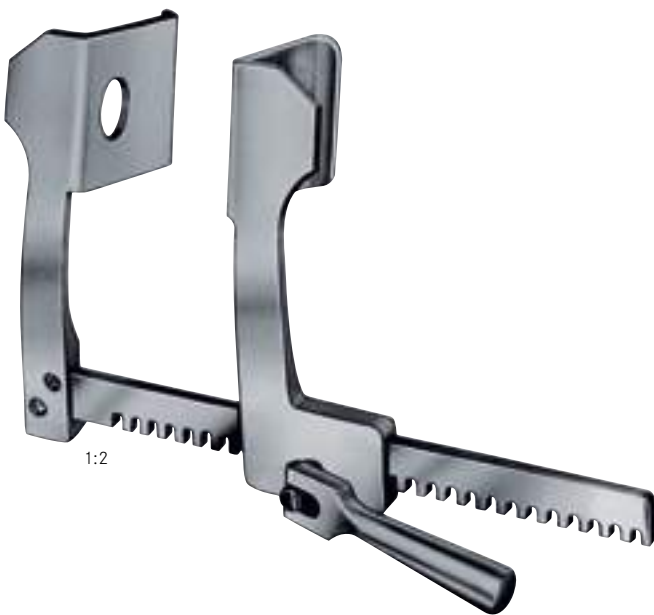
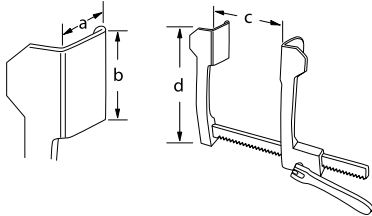

FINOCHIETTO

	a	b	c	d
tk24808-03	85 mm	65 mm	175 mm	145 mm

grosses Modell, für Erwachsene, Aluminium
large size, for adults, aluminium

grand modèle, pour adultes, aluminium
modelo grande, para adultos, aluminio
modello grande, per adulti, alluminio

FINOCHIETTO

	a	b	c	d
tk24808-02	52 mm	62 mm	175 mm	145 mm

mittleres Modell, für Erwachsene, Aluminium
medium size, for adults, aluminium

moyen modèle, pour adultes, aluminium
modelo medio, para adultos, aluminio
modello medio, per adulti, alluminio

FINOCHIETTO

	a	b	c	d
tk24808-01	38 mm	44 mm	135 mm	110 mm

kleines Modell, auch für Kinder geeignet, Aluminium
small size, for children too, aluminium

petit modèle, également pour enfants, aluminium
modelo pequeño, también para niños, aluminio
modello piccolo, pure per bambini, alluminio

FINOCHIETTO-
BABY-HAIGHT

	a	b	c	d
tk24809-01	27 mm	30 mm	95 mm	80 mm

für Kinder, Aluminium
for children, aluminium

pour enfants, aluminium
para niños, aluminio
per bambini, alluminio

FINOCHIETTO-
INFANT

	a	b	c	d
tk24808-05	12 mm	15 mm	70 mm	55 mm

für Säuglinge, Aluminium
for infants, aluminium

pour nourissons, aluminium
para lactantes, aluminio
per lattanti, alluminio

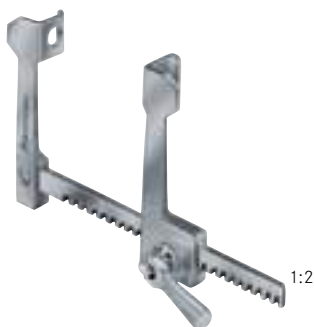

Rippensperrer
Rib retractors

Ecarteurs des côtes
Separadores costales
Divaricatori costali

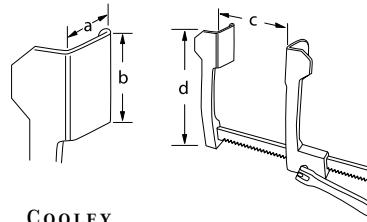

COOLEY

	a	b	c	d
tk 24812-00	35 mm	100 mm	180 mm	180 mm

für Erwachsene, Aluminium
for adults, aluminium

pour adultes, aluminium
para adultos, aluminio
per adulti, alluminio

COOLEY

	a	b	c	d
tk 24812-01	35 mm	115 mm	230 mm	205 mm

extra gross, für Erwachsene, Aluminium
extra large, for adults, aluminium

extra grand, pour adultes, aluminium
extra grande, para adultos, aluminio
extra grande, per adulti, alluminio



COOLEY

	a	b	c	d
tk 24812-02	35 mm	50 mm	200 mm	145 mm

für Erwachsene, Standardgröße, modifiziert, Aluminium
for adults, standard size, modified, aluminium

pour adultes, standard, modifié, aluminium
para adultos, estandard, modificado, aluminio
per adulti, standard, modificato, alluminio

COOLEY

	a	b	c	d
tk 24812-03	20 mm	45 mm	140 mm	110 mm

für Kinder, modifiziert, Aluminium
for children, modified, aluminium

pour enfants, modifié, aluminium
para niños, modificado, aluminio
per bambini, modificato, alluminio

Rippensperrer
Rib retractors

Ecarteurs des côtes
Separadores costales
Divaricatori costali

ALUK

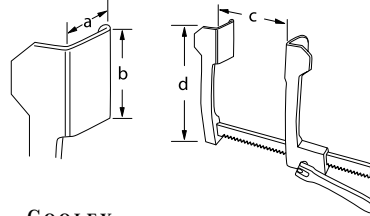

COOLEY

	a	b	c	d
tk 24812-04	30 mm	35 mm	140 mm	110 mm

für Kinder, Aluminium
for children, aluminium

pour enfants, aluminium
para niños, aluminio
per bambini, alluminio

COOLEY

	a	b	c	d
tk 24812-05	20 mm	25 mm	100 mm	80 mm

für Säuglinge, Aluminium
for infants, aluminium

pour nourissons, aluminium
para lactantes, aluminio
per lattanti, alluminio

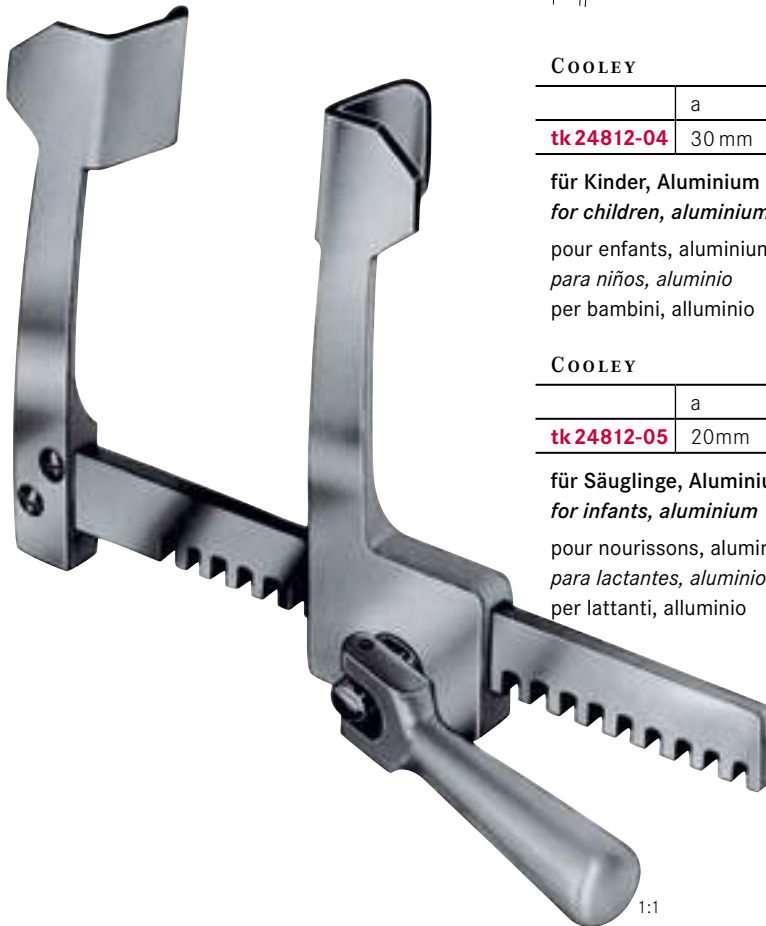

COOLEY

	a	b	c	d
tk 24814-00	12 mm	15 mm	70 mm	55 mm

für Neugeborene, Aluminium
for newbornes, aluminium

pour nouveau-nés, aluminium
para recién nacidos, aluminio
per neonati, alluminio

Rippensperrer
Rib retractors

Ecarteurs des côtes
Separadores costales
Divaricatori costali

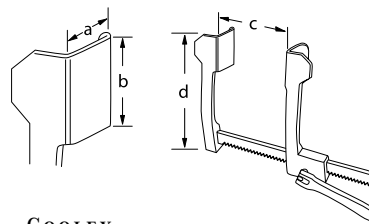

COOLEY

	a	b	c	d
tk 24815-00	15 mm	30 mm	140 mm	80 mm

für Kinder, Sternotomiespreizer, leicht aber trotzdem kräftig, Aluminium
for children, sternal spreader, light-weight but sturdy, aluminium
pour enfants, écarteur sternal, léger mais fort, aluminium
para niños, separador sternal, ligero y fuerte, aluminio
per bambini, divaricatore sternale, leggero ma forte, alluminio

COOLEY

	a	b	c	d
tk 24815-01	12 mm	13 mm	95 mm	55 mm

für Neugeborene, Aluminium
for newbornes, aluminium
pour nouveau-nés, aluminium
para recién nacidos, aluminio
per neonati, alluminio

COOLEY

	a	b	c	d
tk 24812-06	15 mm	20 mm	100 mm	80 mm

für Säuglinge, Sternotomiespreizer mit Dornen, Aluminium
for infants, sternal spreader with prongs, aluminium
pour nourissons, écarteur sternal avec poinçons, aluminium
para lactantes, separador sternal con espigas, aluminio
per lattanti, divaricatore sternale con spine, alluminio

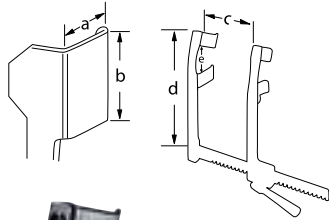
Rippensperrer
Rib retractors
Ecarteurs des côtes
Separadores costales
Divaricatori costali
ALUK

MORSE STERNAL

	a	b	c	d	e
tk 24816-04	20 mm	20 mm	155 mm	120 mm	50 mm

mit 2 Paar beweglichen Valven, für Kinder,
 Biegung der Spreizarme zwischen den Valven, Aluminium
with 2 pairs movable blades, for children, arms curved between blades, aluminium
 avec 2 paires de valves mobiles, pour enfants, courbure entre les valves, aluminium
 con 2 pares de valvas móviles, para niños, curvado entre las valvas, aluminio
 con 2 paia di valve mobili, per bambini, branche curvate, alluminio

MORSE-FAVALORO STERNAL

	a	b	c	d	e
tk 24816-02	40 mm	20 mm	155 mm	175 mm	65 mm

mit 2 Paar beweglichen Valven, für Erwachsene,
 Biegung der Spreizarme zwischen den Valven, Aluminium
with 2 pairs movable blades, for adults, arms curved between blades, aluminium
 avec 2 paires de valves mobiles, pour adultes, courbure entre les valves, aluminium
 con 2 pares de valvas móviles, para adultos, curvado entre las valvas, aluminio
 con 2 paia di valve mobili, per adulti, branche curvate, alluminio

MORSE-FAVALORO STERNAL

	a	b	c	d	e
tk 24816-01	17 mm	22 mm	160 mm	120 mm	50 mm

mit 2 Paar beweglichen Valven, für Kinder, Biegung der Spreizarme zwischen
 den Valven, Aluminium
with 2 pairs movable blades, for children, arms curved between blades, aluminium
 avec 2 paires de valves mobiles, pour enfants, courbure entre les valves, aluminium
 con 2 pares de valvas móviles, para niños, curvado entre las valvas, aluminio
 con 2 paia di valve mobili, per bambini, branche curvate, alluminio

Rippensperrer
Rib retractors

Ecarteurs des côtes
Separadores costales
Divaricatori costali



MORSE STERNAL

	a	b	c	d	e
tk 24816-00	20 mm	28 mm	210 mm	155 mm	72 mm

mit 2 Paar beweglichen Valven, für Erwachsene,
Biegung der Spreizarme zwischen Zahnstange und Valven, Aluminium
with 2 pairs movable blades, for adults, arms curved between rack and blades, aluminium
avec 2 paires de valves mobiles, pour adultes, courbure entre la base et les valves, aluminium
con 2 pares de valvas móviles, para adultos, curvado entre la base y las valvas, aluminio
con 2 paia di valve mobili, per adulti, branche curvate, alluminio

MORSE STERNAL

	a	b	c	d	e
tk 24816-03	20 mm	20 mm	155 mm	120 mm	50 mm

mit 2 Paar beweglichen Valven, für Kinder,
Biegung der Spreizarme zwischen Zahnstange und Valven, Aluminium
with 2 pairs movable blades, for children, arms curved between rack and blades, aluminium
avec 2 paires de valves mobiles, pour enfants, courbure entre la base et les valves, aluminium
con 2 pares de valvas móviles, para niños, curvado entre la base y las valvas, aluminio
con 2 paia di valve mobili, per bambini, branche curvate, alluminio

Rippensperrer
Rib retractors

Ecarteurs des côtes
Separadores costales
Divaricatori costali

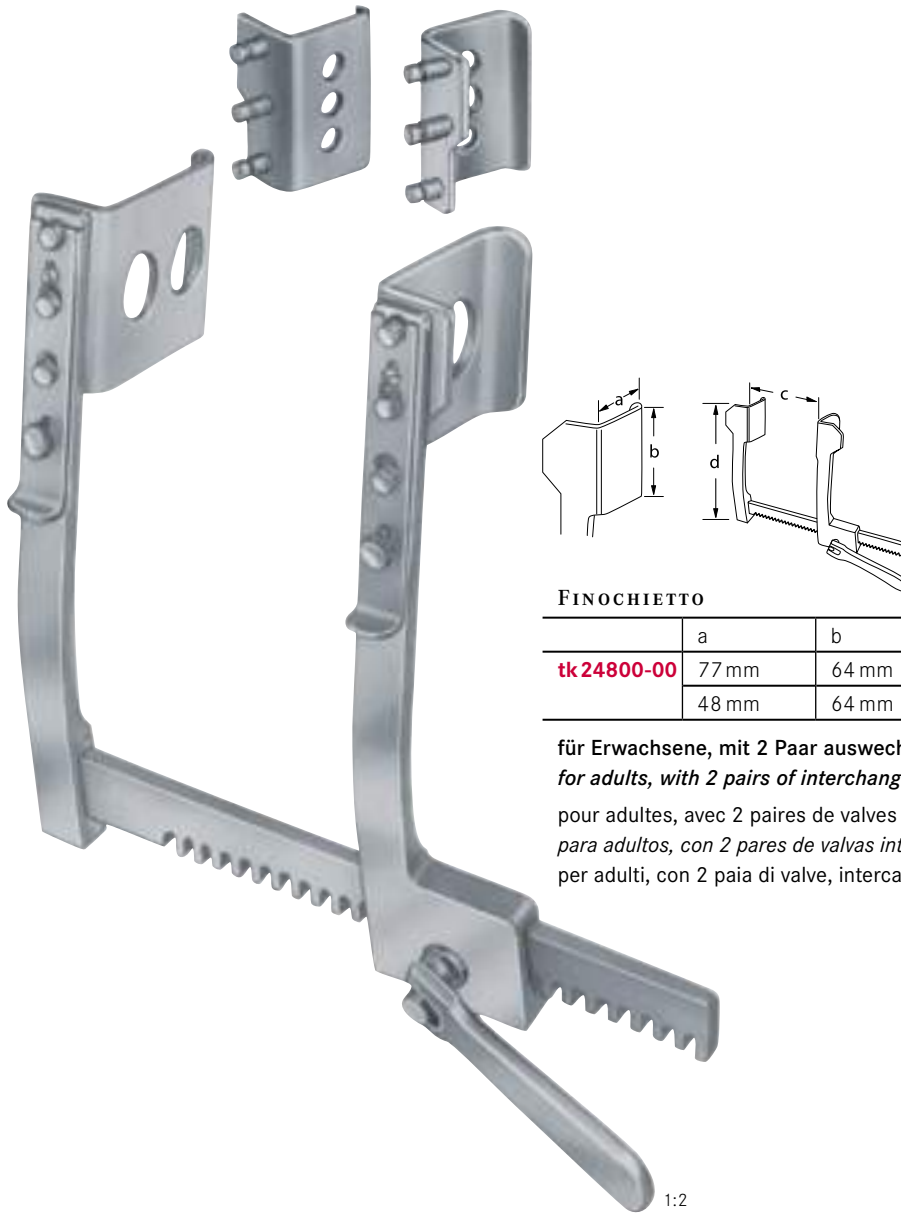

FINOCHIETTO

	a	b	c	d
tk24800-00	77 mm	64 mm	260 mm	195 mm
	48 mm	64 mm		

für Erwachsene, mit 2 Paar auswechselbaren Valven, rostfrei
for adults, with 2 pairs of interchangeable blades, stainless steel
pour adultes, avec 2 paires de valves interchangeables, inoxydables
para adultos, con 2 pares de valvas intercambiables, inoxidable
per adulti, con 2 paia di valve, intercambiabili, inossidabile



BABY-HAIGHT

	a	b	c	d
tk24801-01	28 mm	30 mm	85 mm	70 mm
tk24801-02	28 mm	30 mm	100 mm	75 mm

rostfrei
stainless steel
acier inoxydable
acero inoxidable
acciaio inossidabile

Rippensperrer
Rib retractors

Ecarteurs des côtes
Separadores costales
Divaricatori costali

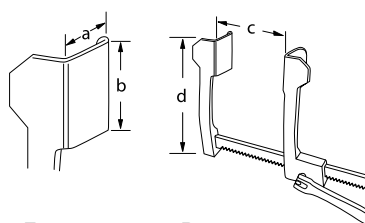

FINOCHIETTO-BABY

	a	b	c	d
tk 24802-07	14 mm	15 mm	75 mm	55 mm

rostfrei
stainless steel
acier inoxydable
acero inoxidable
acciaio inossidabile



FINOCHIETTO

	a	b	c	d
tk 24802-16	40 mm	40 mm	165 mm	110 mm
tk 24802-20	45 mm	65 mm	200 mm	140 mm
tk 24802-25	70 mm	65 mm	250 mm	140 mm

rostfrei
stainless steel
acier inoxydable
acero inoxidable
acciaio inossidabile

Rippensperrer
Rib retractors

Ecarteurs des côtes
Separadores costales
Divaricatori costali



TUFFIER

	a	b	c	d
tk 24803-00	50 mm	45 mm	165 mm	110 mm

rostfrei
stainless steel
acier inoxydable
acero inoxidable
acciaio inossidabile

1:2



FINOCHIETTO-INFANT

	a	b	c	d
tk 24804-05	14 mm	15 mm	55 mm	25 mm

rostfrei
stainless steel
acier inoxydable
acero inoxidable
acciaio inossidabile

1:2

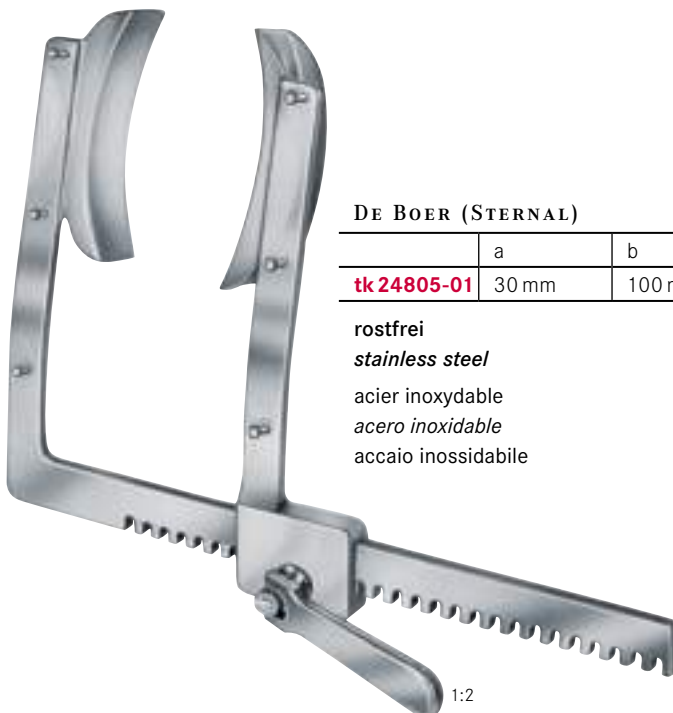

DE BOER (STERNAL)

	a	b	c	d
tk 24805-01	30 mm	100 mm	210 mm	185 mm

rostfrei
stainless steel
acier inoxydable
acero inoxidable
acciaio inossidabile

1:2

Rippensperrer
Rib retractors

Ecarteurs des côtes
Separadores costales
Divaricatori costali

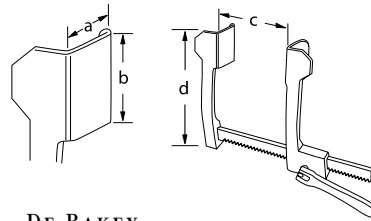

DE BAKEY

	a	b	c	d
tk 24817-01	90 mm	30 mm	150 mm	180 mm
	40 mm	40 mm		
	50 mm	50 mm		

für Kinder, mit 3 Paar auswechselbaren Valven, rostfrei
for children, with 3 pairs of interchangeable blades, stainless steel

pour enfants, 3 paires de valves, interchangeables, inoxydable

para niños, 3 pares de valvas intercambiables, inoxidable

per bambini, 3 paia di valve intercambiabili, inossidabile

	a	b
tk 24817-06	30 mm	30 mm
tk 24817-07	40 mm	40 mm
tk 24817-08	50 mm	50 mm

Valven-Paar, rostfrei für tk 24817-01

Pair of blades, stainless steel for tk 24817-01

Paire de valves, acier inoxydable pour tk 24817-01

Par de valvas, acero inoxidable para tk 24817-01

Paia di valve, acciaio inossidabile per tk 24817-01



DE BAKEY

	a	b	c	d
tk 24817-02	40 mm	100 mm	200 mm	225 mm
	50 mm	80 mm		
	60 mm	60 mm		

für Erwachsene, mit 3 Paar auswechselbaren Valven, rostfrei

for adults, with 3 pairs of interchangeable blades, stainless steel

pour adultes, 3 paires de valves, interchangeables, inoxydable

para adultos, 3 pares de valvas intercambiables, inoxidable

per adulti, 3 paia di valve intercambiabili, inossidabile

	a	b
tk 24817-16	40 mm	100 mm
tk 24817-17	50 mm	80 mm
tk 24817-18	60 mm	60 mm

Valven-Paar, rostfrei für tk 24817-02

Pair of blades, stainless steel for tk 24817-02

Paire de valves, acier inoxydable pour tk 24817-02

Par de valvas, acero inoxidable para tk 24817-02

Paia di valve, acciaio inossidabile per tk 24817-02

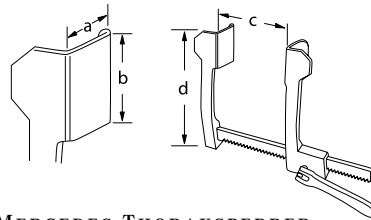
Rippensperrer
Rib retractors
Ecarteurs des côtes
Separadores costales
Divaricatori costali

MERCEDES THORAXSPERRER

	a	b	c	d
tk 24819-00	45 mm	68 mm	285 mm	185 mm
	70 mm	75 mm		

für Erwachsene, mit 2 Paar auswechselbaren Valven mit Kugelschnellverschluss, rostfrei
for adults, with 2 pairs of interchangeable blades with ball snap system, stainless steel
 pour adultes, avec 2 paires de valves interchangeables fermeture à boules, inoxydable
para adultos, con 2 pares de valvas intercambiables fijación con bolas, inoxidable
 per adulti, con 2 paia di valve intercambiabili, inossidabile

	a	b
tk 24819-01	45 mm	68 mm
tk 24819-02	70 mm	75 mm

Valven-Paar, rostfrei
Pair of blades, stainless steel

Paire de valves, acier inoxydable

Par de valvas, acero inoxidable

Paia di valve, acciaio inossidabile

Rippensperrer
Rib retractors

Ecarteurs des côtes
Separadores costales
Divaricatori costali



I.M.A.
tk 24832-00

komplett
complete
complet
complete
completa

1 x **tk 24832-01**

Rahmen
frame
cadre
cuadro
quadro

1 x **tk 24832-02**

Doppel-Valve
double blade
valve jumelée
valva doble
valva doppia

1 x **tk 24832-03**

Doppel-Valve mit Nut
double blade with groove
valve jumelée avec rainure
valva doble con la ranura
valva doppia con gola

1 x **tk 24832-04**

T-Halterung
T-holder
T-support
T-soporte
supporto a T

2 x **tk 24832-05**

Universalklemmen
universal clamp
pinze universale
pinza universal
morsetto universal

2 x **tk 24832-06**

Cooley Valve klein
Cooley blade small
Cooley valve petit
Cooley valva pequeña
Cooley valva piccolo

1 x **tk 24832-07**

Cooley Valve mittel
Cooley blade medium
Cooley valve moyen
Cooley valva mediana
Cooley valva media

1 x **tk 24832-08**

Cooley Valve groß
Cooley blade large
Cooley valve grand
Cooley valva grande
Cooley valva grande

2 x **tk 24832-09**

Ribbon Valve biegsam
Ribbon blade malleable
Ribbon valve malleable
Ribbon valva malleable
Ribbon valva flessibile

I.M.A. Thoraxsperrer
Thoracic and I.M.A. retractor

Ecarteur thoracique et I.M.A.
Separador torácico e I.M.A.
 Divaricatore per il torace ed I.M.A.

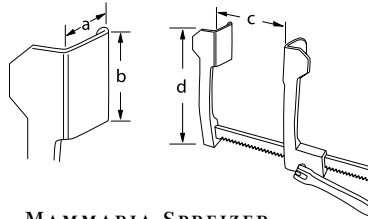

MAMMARIA-SPREIZER

	a	b	c	d
tk24821-00	50 mm	150 mm	134 mm	195 mm

mit abnehmbarer Kippvalve und Stellschraube zum Anheben der Brustwand bei der Mammaria-Dissektion, rostfrei

with detachable tilting IMA-blade and set-screw to lift the sternal margin for the dissection of the IMA, stainless steel

avec valve mobile, demontable, écrou pour soulever le thorax pendant des dissections IMA, inoxydable

con valva móvil y desmontable, rosca para levantar el tórax durante la dissection IMA, inoxidable

con valve smontabili e vite di fissaggio per alzare lo sterno per dissezione IMA, inossidabile

Lungenspatel
Lung spatula

Spatules pulmonaires
Espátula pulmonar
Spatole per polmone



ALLISON

300 mm - 12" tk 24825-30

320 mm - 12½" tk 24825-32



ALLISON

260 mm - 10¼" tk 24825-26

310 mm - 12¼" tk 24825-31

Rippenkontraktoren
Rib contractors

Rapprocheurs
Aproximadores para costillas
Approssimatori costali



1:2

BAILEY

160 mm - 6¼" **tk 24830-16**



1:2

BAILEY-BABY

140 mm - 5½" **tk 24831-14**



1:2

BAILEY-GIBBON

160 mm - 6¼" **tk 24833-16**



1:2

SELLORS

190 mm - 7½" **tk 24837-19**



LEMMON

145 mm - 5¾" **tk 24835-14**

180 mm - 7" **tk 24835-18**



Magen, Darm
Stomach, Intestine

Estomac, Intestins
Estómago, Intestino
Stomaco, Intestino



Gewebe- und Darmfasszangen
Tissue and intestinal holding forceps

Pinces intestinales et de tissu
Pinzas para tejidos y intestinos
Pinze per tessuti ed intestinali



ALLIS-BABY

140 mm - 5½" **tk 28100-14**

Zähne 4x5

Teeth

Dents

Dientes

Denti



ALLIS

150 mm - 6" **tk 28140-15** **tk 28160-15**

190 mm - 7½" **tk 28160-19**

250 mm - 9¾" **tk 28160-25**

Zähne 4x5

5x6

Teeth

Dents

Dientes

Denti



ALLIS-ADAIR

155 mm - 6" **tk 28167-15**

Zähne 10x11

Teeth

Dents

Dientes

Denti



THOMS-ALLIS

200 mm - 8" **tk 28180-20**

6x7



LOCKWOOD

200 mm - 8" **tk 28190-20**

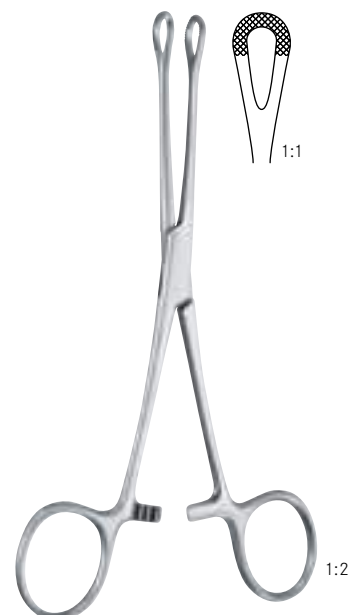

WILLIAMS

160 mm - 6¼" **tk 28192-16**

Gewebe- und Darmfazzangen
Tissue and intestinal holding forceps

Pinces intestinales et de tissue
Pinzas para tejidos y intestinos
Pinze per tessuti ed intestinali

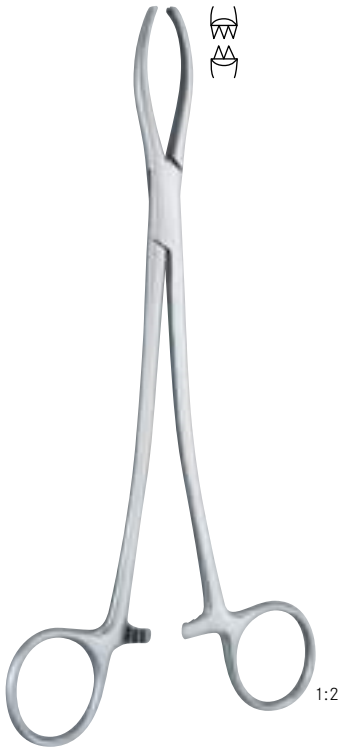

LITTLEWOOD

190 mm - 7½" **tk 11955-19**

Zähne 2x3

Teeth

Dents

Dientes

Denti



BOYS-ALLIS

150 mm - 6" **tk 28210-15**

Zähne 5x6

Teeth

Dents

Dientes

Denti



JUDD-ALLIS

150 mm - 6" **tk 28250-15**

190 mm - 7½" **tk 28250-19**

Zähne 3x4

Teeth

Dents

Dientes

Denti



BABCOCK

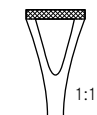

160 mm - 6¼"

200 mm - 8"

tk 28285-16

tk 28285-20

TUCAR TK

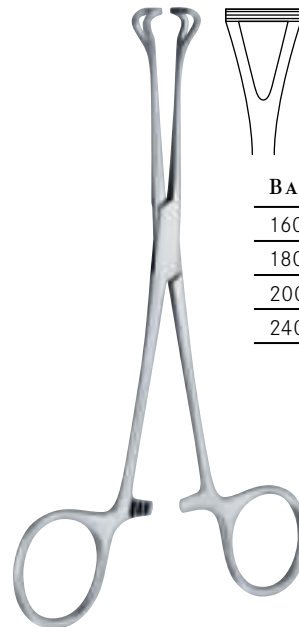

BABCOCK

160 mm - 6¼" **tk 28280-16**

180 mm - 7" **tk 28280-18**

200 mm - 8" **tk 28280-20**

240 mm - 9½" **tk 28280-24**

Gewebe- und Darmfasszangen
Tissue and intestinal holding forceps

Pinces intestinales et de tissu
Pinzas para tejidos y intestinos
 Pinze per tessuti ed intestinali

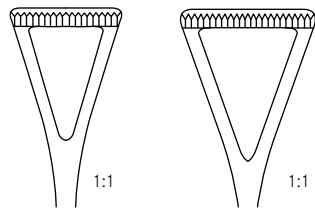
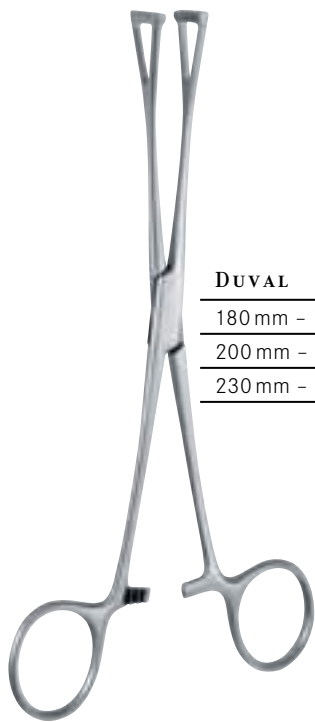

DUVAL

180 mm - 7"	tk 28290-18	
200 mm - 8"	tk 28290-20	tk 28292-20
230 mm - 9"	tk 28290-23	tk 28292-23

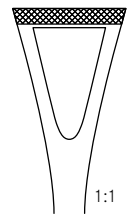

DUVAL

200 mm - 8"	tk 28293-20
-------------	--------------------

TUGARK

Gewebe- und Darmfazzangen
Tissue and intestinal holding forceps

Pinces intestinales et de tissue
Pinzas para tejidos y intestinos
Pinze per tessuti ed intestinali

ATRAUMTK



**BABCOCK-
ATRAUMA**

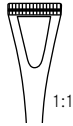

1:1



1:1

160 mm – 6¼"	200 mm – 8"
tk 22452-16	tk 22452-20



**DUVAL-
ATRAUMA**

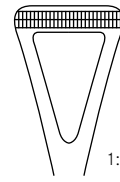

1:1

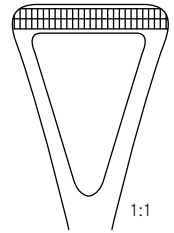

1:1

200 mm – 8"	230 mm – 9"
tk 22455-20	tk 22455-23



**ALLIS-
ATRAUMA**

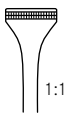

1:1



1:1

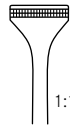

1:1

160 mm – 6¼"	200 mm – 8"	250 mm – 9¾"
tk 22450-16	tk 22450-20	tk 22450-25

Darm- und Magenklammern
Intestinal and stomach clamps

Pinces-clamps pour l'intestin et l'estomac
Pinzas-clamps para el intestino y el estomago
Pinze per intestino e stomaco

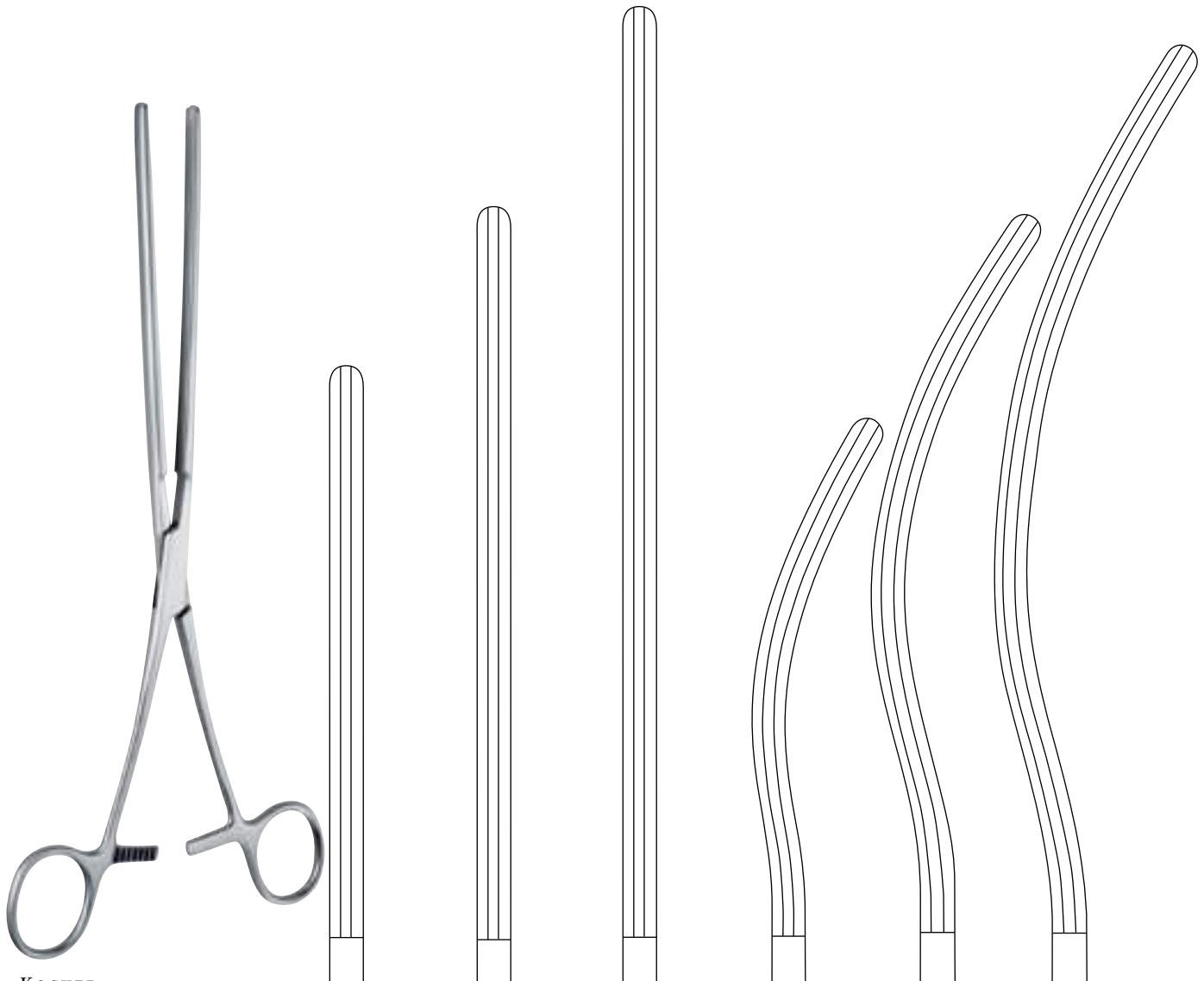

KOCHER

	220 mm - 8¾"	250 mm - 9¾"	280 mm - 11"	220 mm - 8¾"	250 mm - 9¾"	280 mm - 11"
	tk 28300-22	tk 28300-25	tk 28300-28	tk 28301-22	tk 28301-25	tk 28301-28

Darm- und Magenklappen
Intestinal and stomach clamps

Pinces-clamps pour l'intestin et l'estomac
Pinzas-clamps para el intestino y el estomago
 Pinze per intestino e stomaco

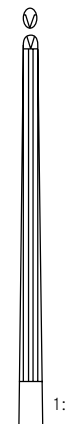
ALLEN
 155 mm – 6" | **tk 28302-15**



1x2
 Darmklemme für Kinder
Intestinal clamp for children
 Pince intestinal pour enfants
Pinza intestinal para niños
 Pinza intestinale per bambini





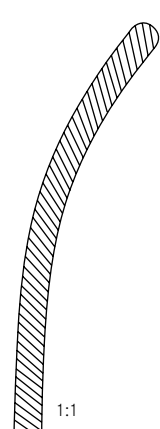

BABY-KOCHER
 130 mm – 5" | **tk 28305-13** | **tk 28306-13**

Darmklemme für Kinder, sehr elastisch
Intestinal clamp for children, very elastic blades
 Pince intestinal pour enfants, très élastique
Pinza intestinal para niños, muy elastica
 Pinza intestinale per bambini, molto elastica

BABY-DOYEN
 180 mm – 7" | **tk 28314-18** | **tk 28315-18**

DOYEN
 210 mm – 8¼" | **tk 28310-21** | **tk 28311-21**
 230 mm – 9" | **tk 28310-23** | **tk 28311-23**

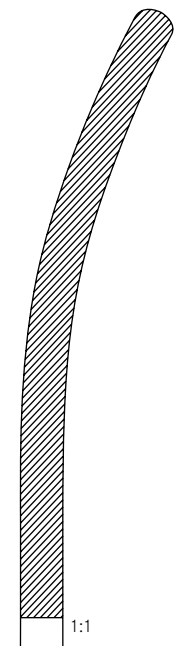
Darm- und Magenklammern
Intestinal and stomach clamps

Pinces-clamps pour l'intestin et l'estomac
Pinzas-clamps para el intestino y el estomago
Pinze per intestino e stomaco

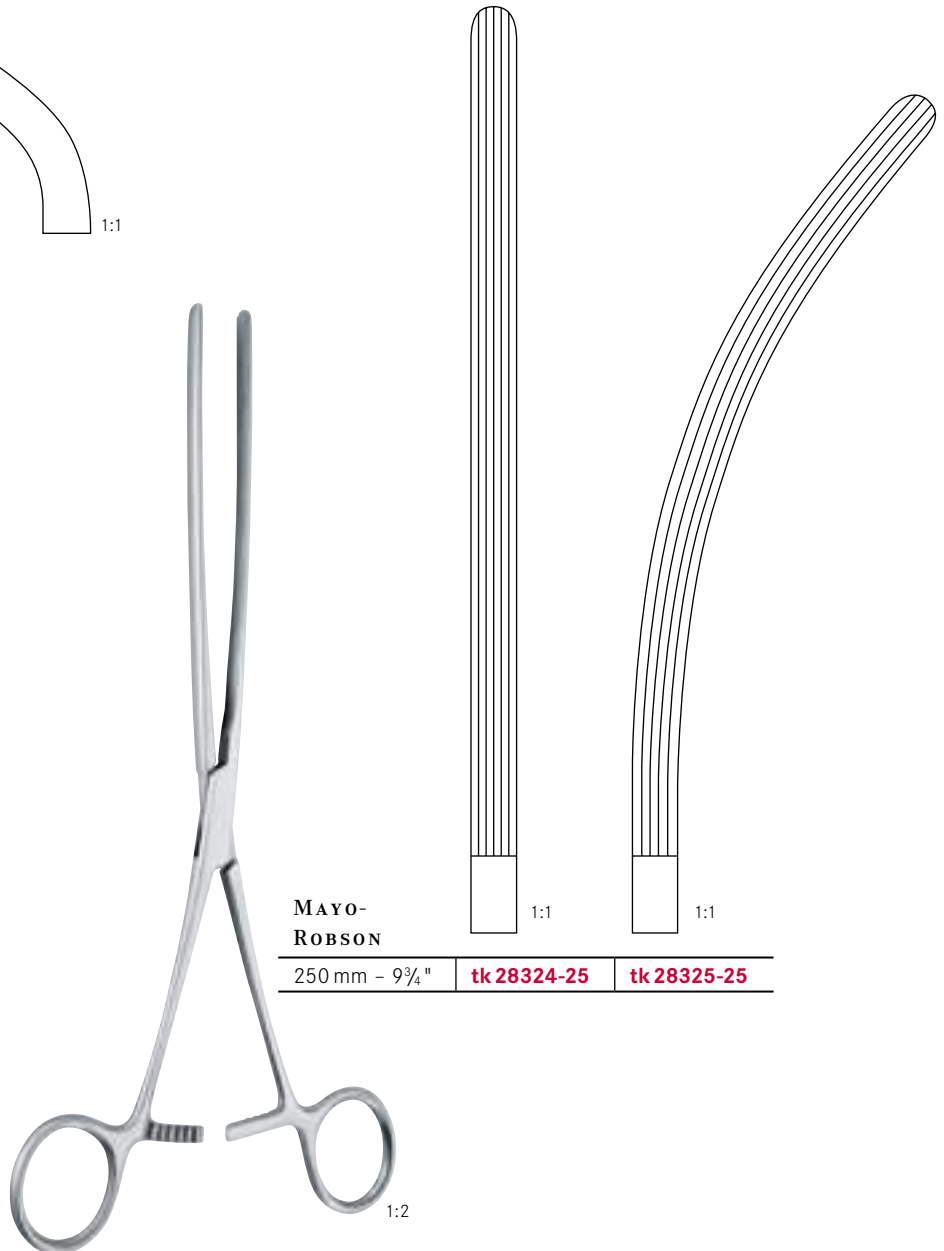
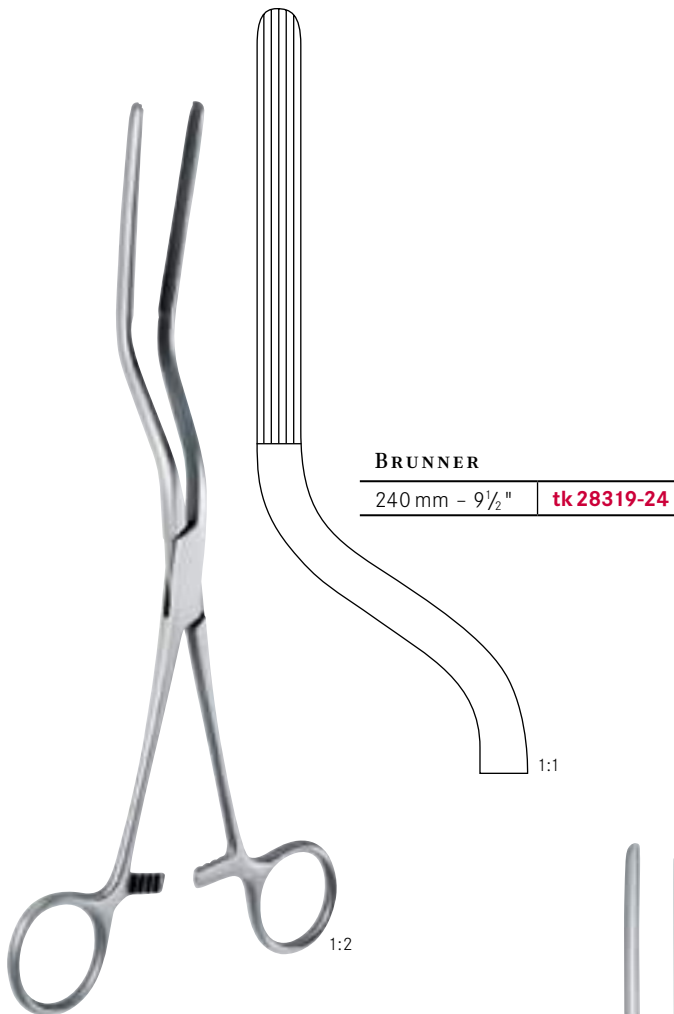

Darm- und Magenklammern
Intestinal and stomach clamps

Pinces-clamps pour l'intestin et l'estomac
Pinzas-clamps para el intestino y el estomago
Pinze per intestino e stomaco

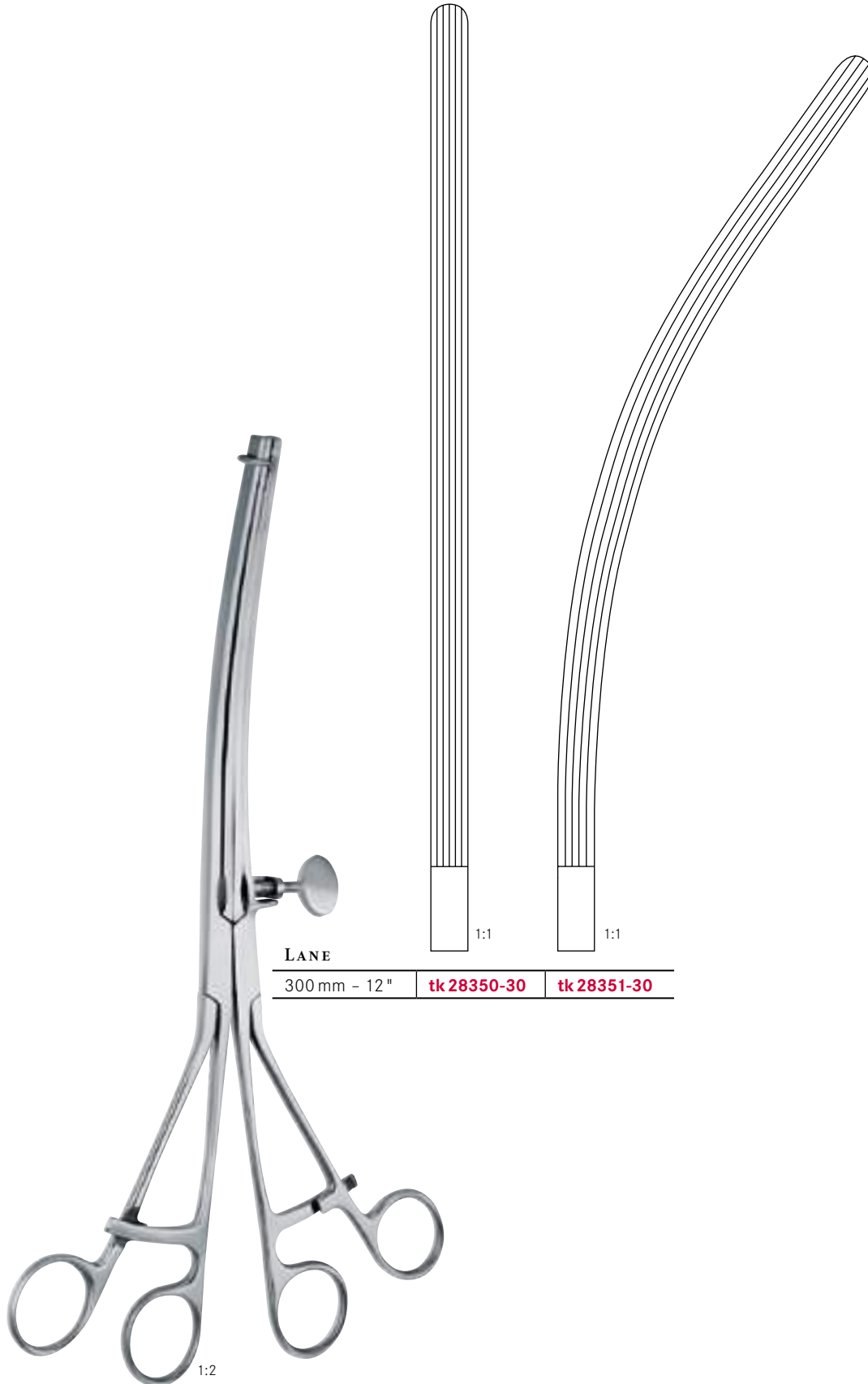

Atraumatische Darmklemmen
Atraumatic intestinal clamp forceps

Pinces-clamps atraumatiques pour l'intestin
Pinzas-clamps atraumáticas intestinales
Pinze intestinali atraumatiche

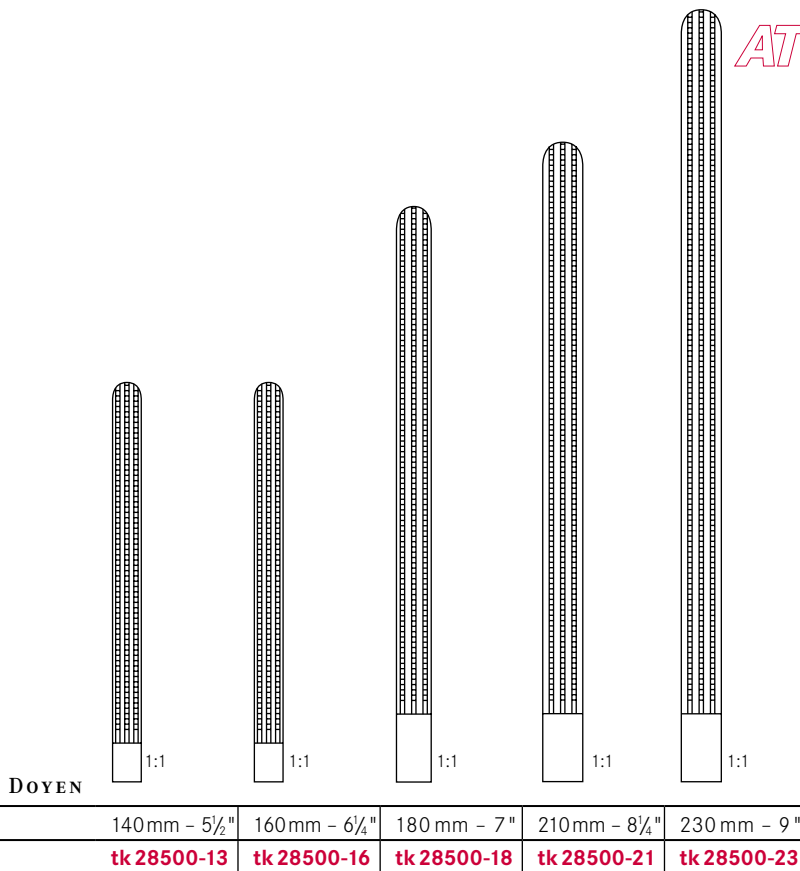

ATRAUMTK

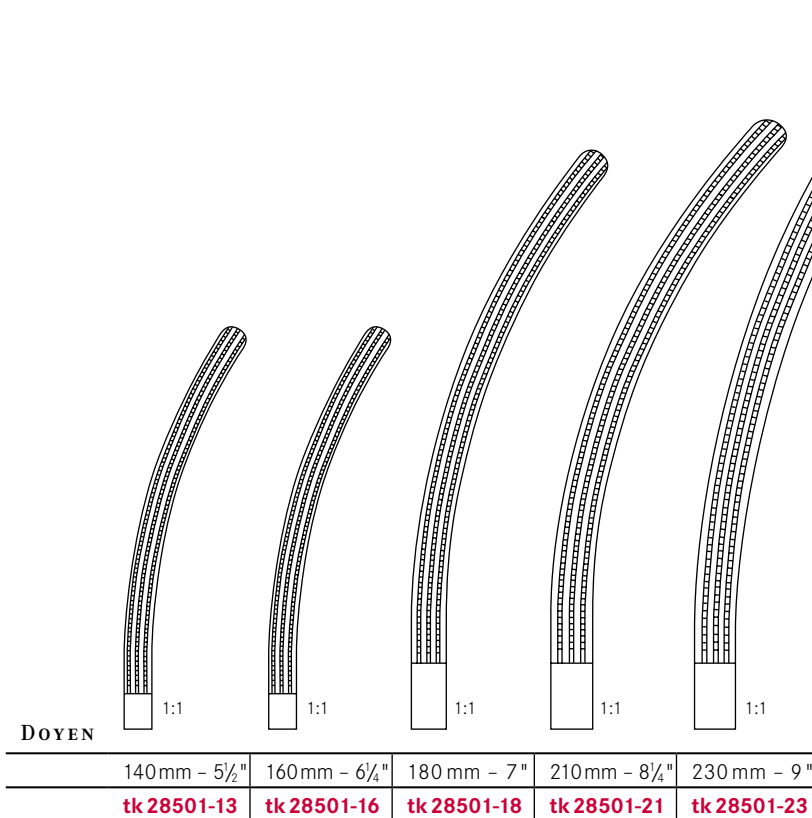

Atraumatische Darmklemmen
Atraumatic intestinal clamp forceps

Pinces-clamps atraumatiques pour l'intestin
Pinzas-clamps atraumáticas intestinales
Pinze intestinali atraumatiche

ATRAUMTK

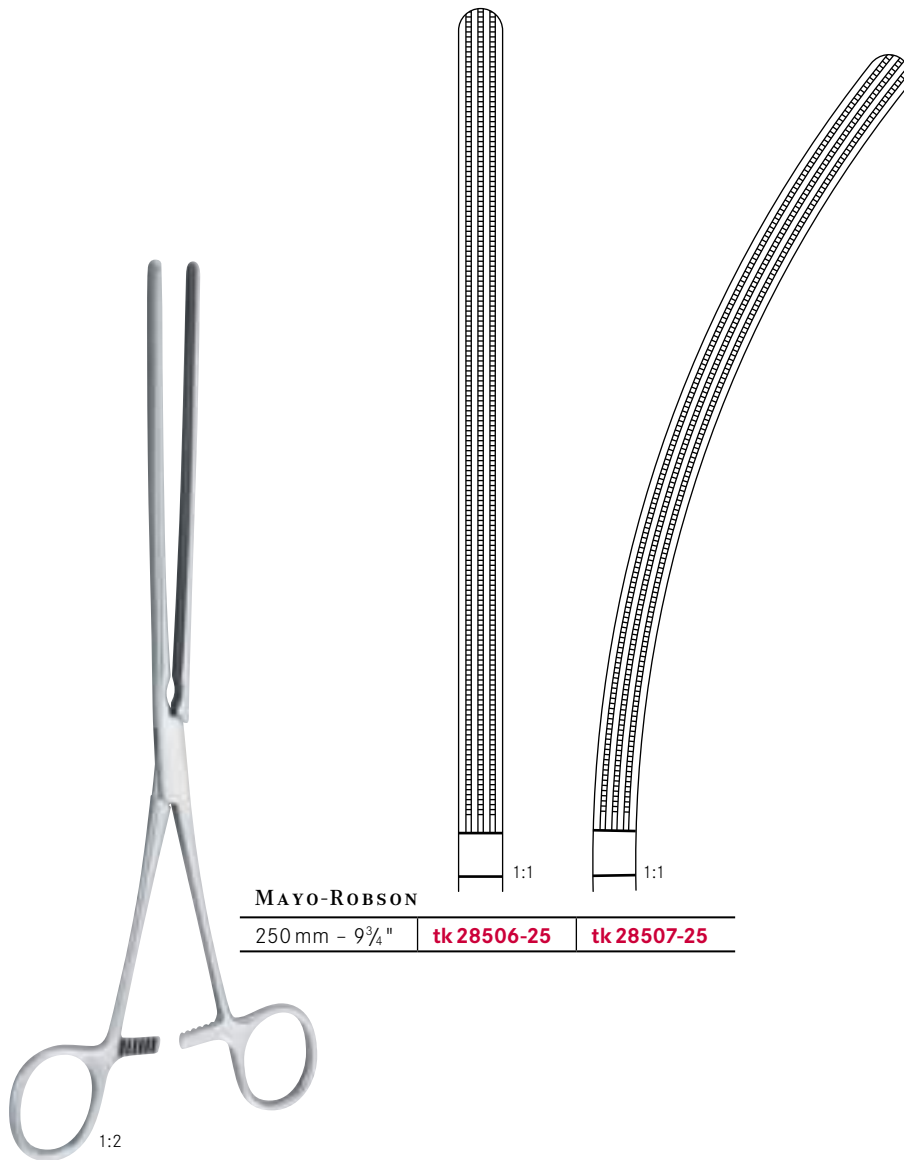

Atraumatische Darmklemmen
Atraumatic intestinal clamp forceps

Pinces-clamps atraumatiques pour l'intestin
Pinzas-clamps atraumáticas intestinales
Pinze intestinali atraumatiche

ATRAUMTK

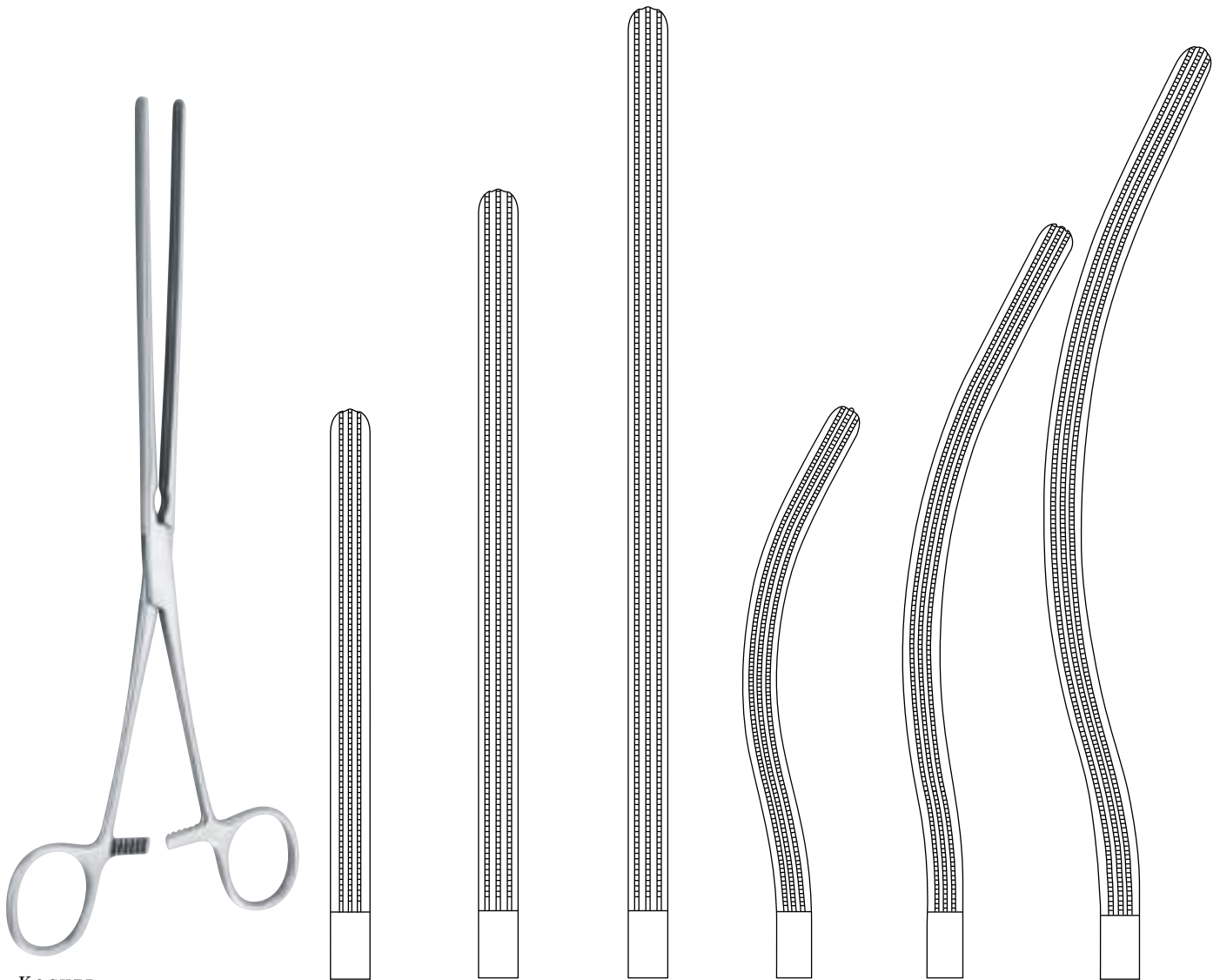

KOCHER

	220 mm - 8 ³ / ₄ "	250 mm - 9 ³ / ₄ "	280 mm - 11 "	220 mm - 8 ³ / ₄ "	250 mm - 9 ³ / ₄ "	280 mm - 11 "
	tk 28510-22	tk 28510-25	tk 28510-28	tk 28511-22	tk 28511-25	tk 28511-28

Atraumatische Darmklemmen
Atraumatic intestinal clamp forceps

Pinces-clamps atraumatiques pour l'intestin
Pinzas-clamps atraumáticas intestinales
Pinze intestinali atraumatiche

ATRAUMTK



RESANO

300 mm - 12"

tk 28529-30

1:1

1:2

Rektum-Anastomosenklemmen
Sigmoid anastomosis forceps

Pinces pour anastomoses rectales
Pinzas para anastomosis rectales
 Pinze per anastomosi rettali

ATRAUMTK

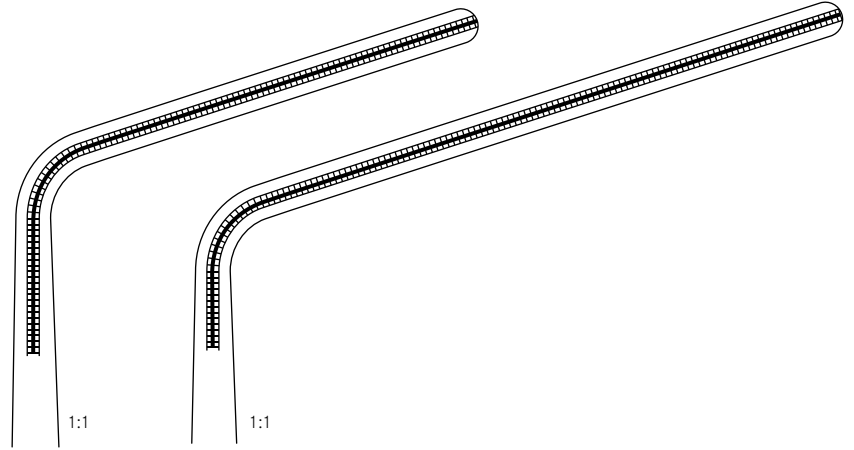

HAYES

260 mm - 10 1/4"	280 mm - 11"
tk 28526-26	tk 28526-28

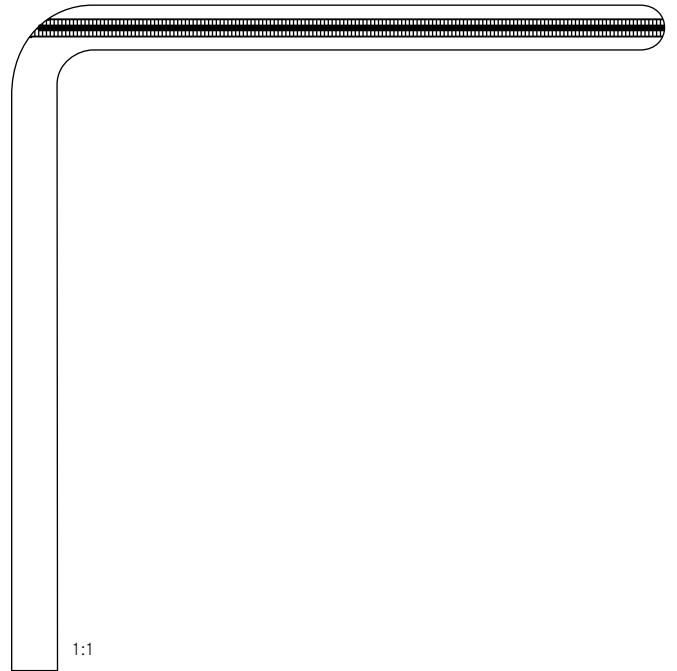

FEHLÄND

240 mm - 9 1/2"
tk 28528-24

Rektum-Anastomosenklemmen
Sigmoid anastomosis forceps

Pinces pour anastomoses rectales
Pinzas para anastomosis rectales
Pinze per anastomosi rettali

ATRAUMTK

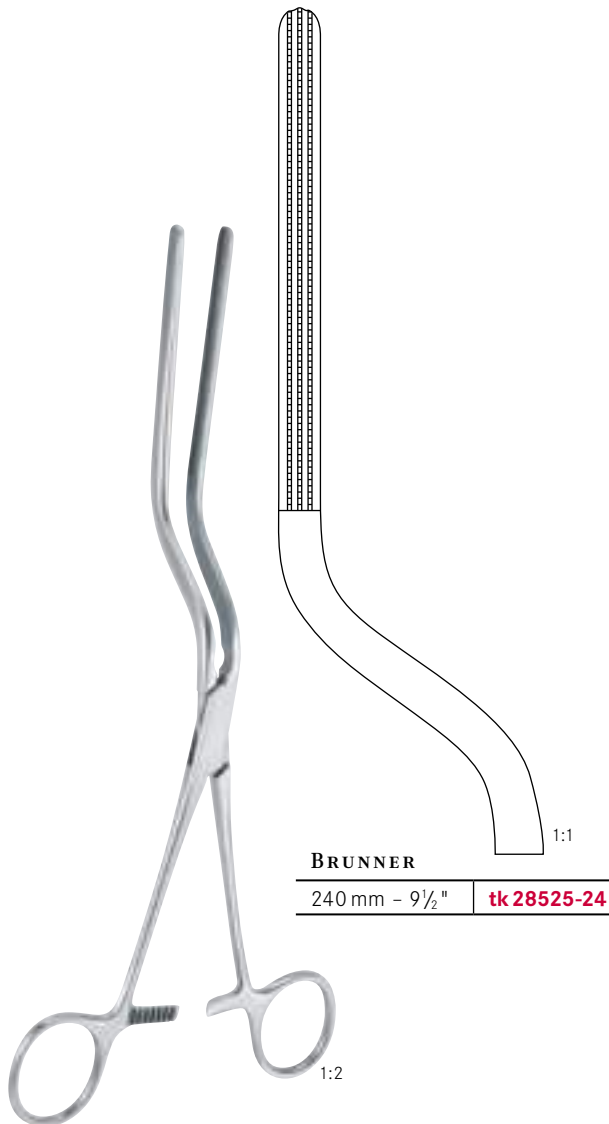

Atraumatische Organfasszangen
Atraumatic organ grasping forceps

Pinces atraumatiques pour saisir des organes
Pinzas atraumaticas para sacar órganos
Pinze atraumatiche per afferrare organi

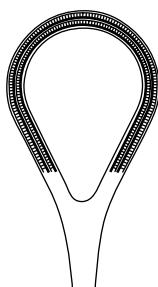

250 mm - 9 3/4" **tk 22014-25**

Organfasszange mittel, 250 mm
Organ grasping forceps medium, 250 mm

Pince medium pour saisir des organes, 250 mm
Pinza mediano para sacar órganos, 250 mm
Pinza per afferrare organi, 250 mm

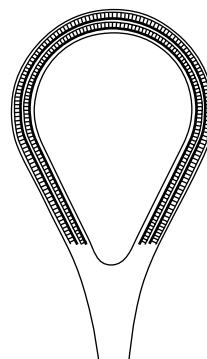

260 mm - 10 1/4" **tk 22014-26**

Organfasszange gross, 260 mm
Organ grasping forceps large, 260 mm

Pince grande pour saisir des organes, 260 mm
Pinza grande para sacar órganos, 260 mm
Pinza per afferrare organi, 260 mm

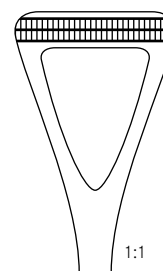
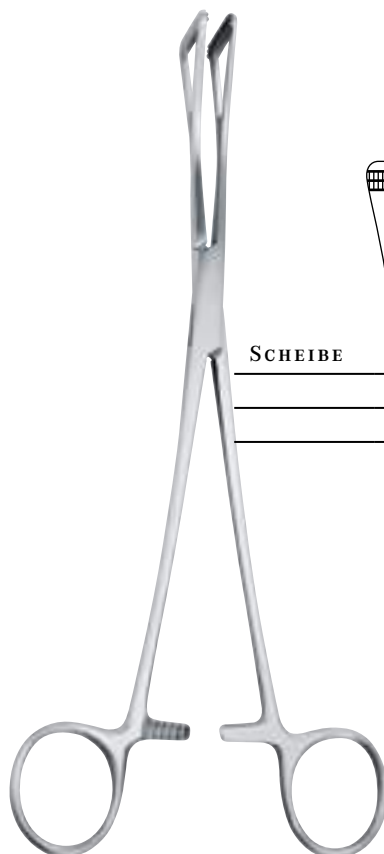

SCHEIBE

180 mm - 7"	200 mm - 8"	230 mm - 9"
tk 28470-18	tk 28470-20	tk 28470-23

schmal
narrow
étroit
estrecho
stretto

mittel
medium
moyen
mediano
medio

breit
wide
large
ancho
largo

Darmquetschklemmen
Intestinal and pylorus clamps

Ecraseur pour l'intestin
Pinzas intestinales para píloro
Schiacciatori intestinali



1:2



1:1

PAYR-BABY

150 mm – 6" **tk 28410-15**

mit Stift
with pin

avec cheville
con pivote
con perno



1:2

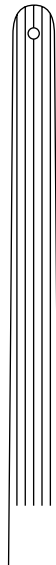

1:1



1:1

PAYR

210 mm – 8¼"

290 mm – 11½"

tk 28410-21

tk 28410-29

mit Stift
with pin

avec cheville
con pivote
con perno

Darm- und Darm-Anastomosenklemmen
Intestinal and Intestinal Anastomosis clamp forceps

Pinces-clamps intestinales et à anastomose intestinales
Pinzas-clamps intestinales y para anastomosis intestinales
 Pinze intestinali e pinze per anastomosi intestinali



1:2

85 mm - 3¼" **tk 28452-08**

DE MARTEL-
WOLFSON



1:2

230 mm - 9" **tk 28452-23**



1:2

DE MARTEL-
WOLFSON

260 mm - 10¼" **tk 28451-26**

Darm- und Anastomosenklemmen
Intestinal and anastomosis clamp forceps

Pinces-clamps intestinales et à anastomose
Pinzas-clamps intestinales y para anastomosis
 Pinze intestinali e per anastomosi



DE MARTEL-
WOLFSON



50 mm - 2"	70 mm - 2 ³ / ₄ "	100 mm - 4"
tk 28450-05	tk 28450-07	tk 28450-10

Satz mit 3 Klemmen
Set of 3 clamps
 Jeu de 3 clamps
Juego de 3 pinzas
 Serie di 3 pezzi

Mastdarm-Spekula
Rectal specula

Spéculums pour le rectum
Espéculos rectales
Specoli rettali



SIMS

	x=80 mm x 15 mm	x=80 mm x 15 mm
150 mm - 6"	tk 29001-15	tk 29002-15

gefenstert
fenestrated
fenêtré
fenestrado
finestrato



MATHIEU

	x=90 mm
195 mm - 7 3/4"	tk 29003-19

1:2

Mastdarm-Spekula
Rectal specula

Spéculums pour le rectum
Espéculos rectales
Specoli rettali



PRATT

	x = 80 mm x 25 mm
205 mm – 8"	tk 29006-20



CZERNY

	x = 110 mm x 25 mm
220 mm – 8¾"	tk 29004-22

Anuskope, Proktoskope, Rektoskope, Sphinkterskope
Anoscopes, Proctoscopes, Rectoscopes, Sphincteroscopes

Anuscopes, Proctoscopes, Rectoscopes, Sphincteroscopes
Anoscopios, Proctoscopios, Rectoscopios, Esfinteroscopios
 Anoscopi, Proctoscopios, Rectoscopios, Sfinteroscopi



IVES-FANSLER	
	x=90mm
22 mm Ø	tk 29011-80

1:2



FANSLER	
	x=65mm
25 mm Ø	tk 29011-91
29 mm Ø	tk 29011-90
38 mm Ø	tk 29011-92

1:2

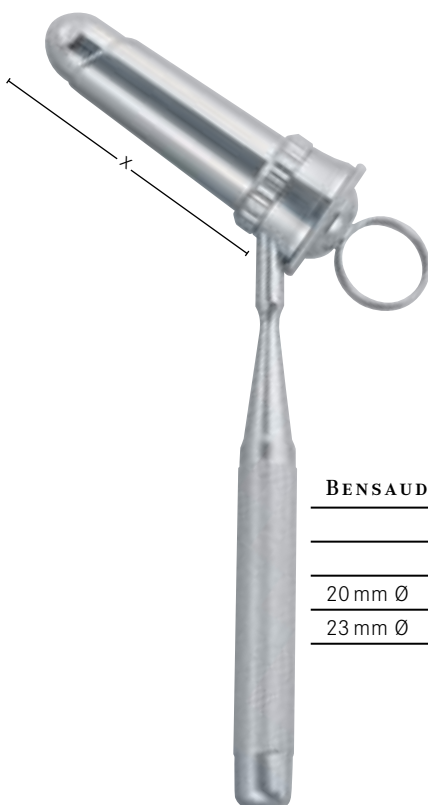

BENSAUDE	
	185 mm - 7 1/4"
	x=55mm
20 mm Ø	tk 29067-20
23 mm Ø	tk 29067-23



KELLY	
	x=50mm
21 mm Ø	tk 29012-50
27 mm Ø	tk 29013-50

Anuskope, Proktoskope, Rektoskope, Sphinkterskope
Anoscopes, Proctoscopes, Rectoscopes, Sphincteroscopes

Anuscopes, Proctoscopes, Rectoscopes, Sphincteroscopes
Anoscopios, Proctoscopios, Rectoscopios, Esfinteroscopios
 Anoscopi, Proctoscopios, Rectoscopios, Sfinteroscopi



KELLY

22 x 50 mm	tk 29057-01
22 x 100 mm	tk 29057-02
22 x 140 mm	tk 29057-03
22 x 200 mm	tk 29057-04

1:2



HIRSCHMANN

16 mm Ø	x = 65 mm	tk 29065-16
19 mm Ø	x = 65 mm	tk 29065-19
22 mm Ø	x = 65 mm	tk 29065-22

1:2

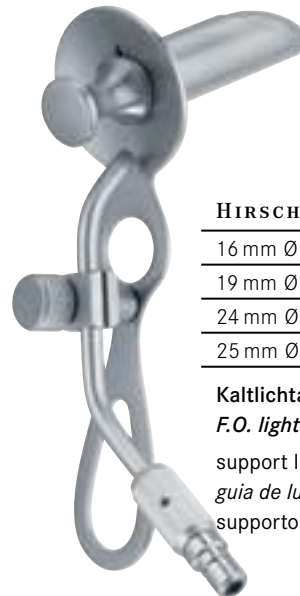

HIRSCHMANN

16 mm Ø	tk 29063-16
19 mm Ø	tk 29063-19
24 mm Ø	tk 29063-24
25 mm Ø	tk 29063-25

Kaltlichtaufsatz, Wolf
F.O. light carrier, Wolf
 support lumière froide, Wolf
guía de luz fría, Wolf
 supporto per luce fredda, Wolf

tk 700-997

Kaltlichtadapter, TEKNO/Storz Anschluss
Cold light, TEKNO/Storz connector
 Adapteur lum. froide, connection TEKNO/Storz
Adaptator luz fría, conexión TEKNO/Storz
 Adattatore luce freddo, attacco TEKNO/Storz

Anal spreizer
Rectal specula

Spéculum pour le rectum
Espéculos rectales
Divaricatore anale



ALAN PARKS

140 mm - 5½" tk 29022-00

komplett mit 2 Paar Valven und 1 Mittelvalve, mit Kaltlichtanschluss TEKNO/Wolf
complete with 2 pair of blades and 1 center blade, with cold light connector TEKNO/Wolf
complet avec 2 paires des valves et 1 valve centrale, avec raccord de lum. froide TEKNO/Wolf
completo con 2 juegos de valvas y 1 valva central, con connector de luz fría TEKNO/Wolf
completo con 2 paia di valve e 1 valva centrale, con attacco di luce fredda TEKNO/Wolf

tk 29022-01

Kaltlicht-Aufsatz
F.O. light carrier

Support lumière froide
Soporte de luz fría
Supporto per luce fredda



SMITH-BUIE

	x = 75 mm x 23 mm
150 mm - 6"	tk 29070-15

Max. Spreizweite 115 mm
Max. spread 115 mm

Écartement maximal 115 mm
Apertura máxima 115 mm
Apertura massima 115 mm

Analpreizer
Rectal specula

Spéculums pour le rectum
Espéculos rectales
Divaricatore anale



1:2

ALAN PARKS

140 mm – 5½" | **tk 29020-00**

komplett mit 2 Paar Valven und 1 Mittelvalve
complete with 2 pair of blades and 1 center blade

complet avec 2 paires des valves et 1 valve centrale
completo con 2 juegos de valvas y 1 valva central
completo con 2 paia di valve e 1 valva centrale

22 mm x 75 mm | **tk 29020-02**

Seitenvalven alleine (Paar)
Lateral blades only (pair)

Valves latérales seules (paire)
Valvas laterales solas (par)
Valve laterali solo (paio)

22 mm x 95 mm | **tk 29020-04**

Seitenvalven alleine (Paar)
Lateral blades only (pair)

Valves latérales seules (paire)
Valvas laterales solas (par)
Valve laterali solo (paio)

25 mm x 95 mm | **tk 29020-06**

Mittelvalve alleine
Central blade only

Valve centrale seule
Valva central sola
Valva centrale solo

Rektoskop <i>Rectoscope</i>	Rectoscope <i>Rectoscopio</i> Rettoscopio
---------------------------------------	---

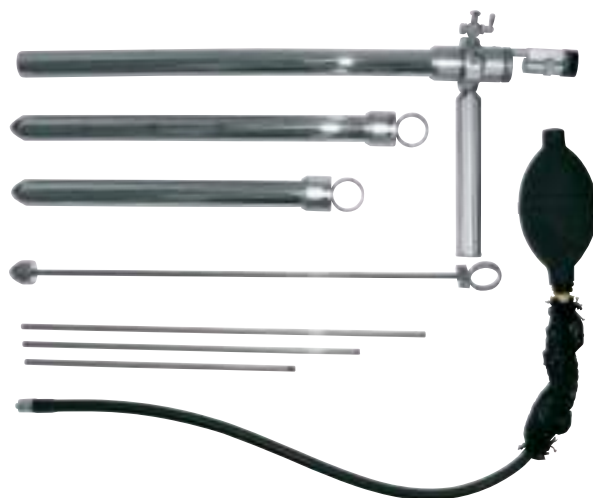
**STRAUSS****tk 28531-01****Kaltlicht-Rektoskop, komplett:**

F/O Rektoskopkopf mit Zweiwegehahn, Verschlussdeckel, Teleskop und Griff,
 je 1 Rektoskoptubus in 200 mm, 250 mm und 300 mm mit 20 mm Ø,
 mit Obturator und F/O Lichtträger Wolf-Anschluss, Doppelgebläse mit Kaltlichteinrichtung

Cold-light rectoscope, complete:

*F/O Rectoscope-head with two-way stop cock, lens cover and telescope handle,
 3 rectoscope-tubes 20 mm Ø 200 mm, 250 mm and 300 mm
 with obturator and F/O light-carrier Wolf, with double blower, with cold light connection*

Rectoscope à lumière froide, complet:

F/O tête de rectoscope avec robinet, protecteur de lentille, optique et manche,
 3 tubes de rectoscope 20 mm Ø, 200 mm, 250 mm et 300 mm de longueur,
 avec mandrin et porte-lumière Wolf (F/O), souffleur et connecteur de lumière froide.

Rectoscopio de luz fría, completo:

*F/O cabeza de rectoscopio, con robinete protector de lentes, optica y mango,
 3 tubos de rectoscopia de 20 mm, Ø 200 mm, 250 mm y 300 mm de longitud,
 con obturador y connector de luz fría Wolf y soplador.*

Luce fredda-Rettoscopio, completo

Testa di rettoscopio con fibre ottiche, con rubinetto a due vie, copri-lente e impugnatura per ottica,
 3 tubi per rettoscopio 20 mm Ø, 200 mm, 250 mm e 300 mm
 con otturatore e cavo luce, insufflatore a doppia palla e connettore per cavo luce, allacciamento Wolf.

tk 700-997**Kaltlichtadapter TEKNO/Storz***Cold light connector TEKNO/Storz*

Raccord de lumière froide TEKNO/Storz

Connector de luz fría TEKNO/Storz

Attacco luce fredda TEKNO/Storz

Mastdarm-Biopsiezangen
Rectal biopsy forceps

Pinces pour la biopsie rectale
Pinzas para biopsia rectal
Pinze taglianti per biopsia rettale

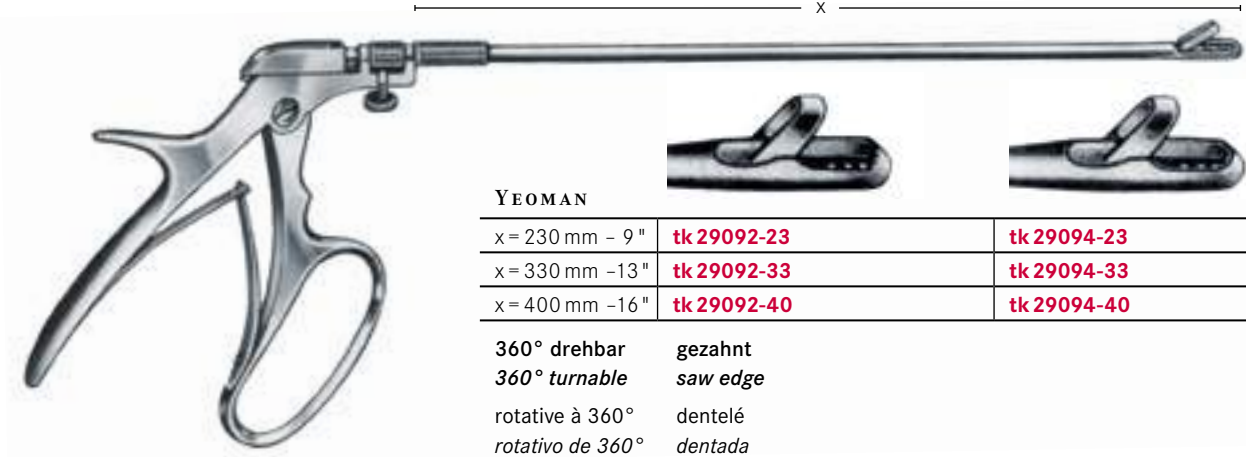

YEOMAN

x = 230 mm - 9"	tk 29092-23	tk 29094-23
x = 330 mm -13"	tk 29092-33	tk 29094-33
x = 400 mm -16"	tk 29092-40	tk 29094-40

360° drehbar gezahnt
360° turnable saw edge
rotative à 360° dentelé
rotativo de 360° dentada
rotativa di 360° dentata





TURREL

x = 230 mm - 9"	tk 29096-23	tk 29098-23
x = 330 mm -13"	tk 29096-33	tk 29098-33
x = 400 mm -16"	tk 29096-40	tk 29098-40

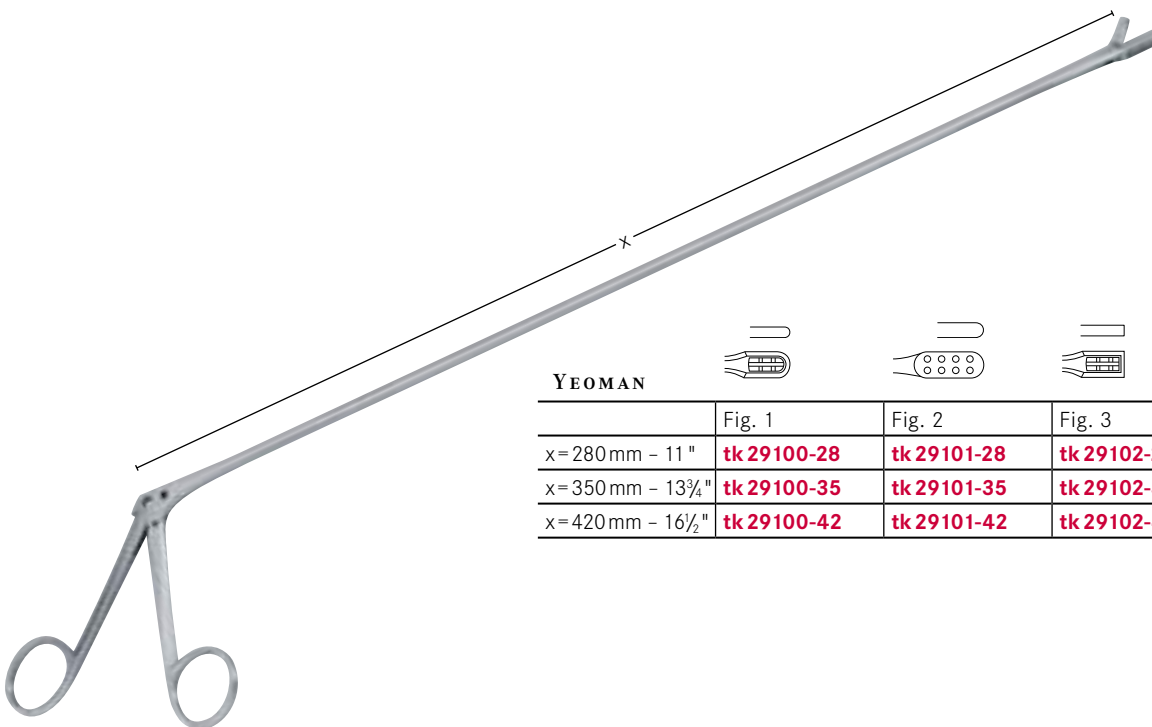
360° drehbar gezahnt
360° turnable saw edge
rotative à 360° dentelé
rotativo de 360° dentada
rotativa di 360° dentata

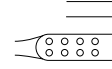

YEOMAN

				
	Fig. 1	Fig. 2	Fig. 3	Fig. 4
x = 280 mm - 11"	tk 29100-28	tk 29101-28	tk 29102-28	tk 29103-28
x = 350 mm - 13¾"	tk 29100-35	tk 29101-35	tk 29102-35	tk 29103-35
x = 420 mm - 16½"	tk 29100-42	tk 29101-42	tk 29102-42	tk 29103-42

Flexible Zangen
Flexible forceps

Pinces flexibles
Pinzas flexibles
Pinze flessibili



	1.8 mm Ø	2.2 mm Ø	2.6 mm Ø	3.4 mm Ø
1200 mm - 47 ¹ / ₄ "	tk 31100-12	tk 31110-12		
1600 mm - 63"	tk 31100-16	tk 31110-16	tk 31120-16	tk 31130-16
1800 mm - 70 ³ / ₄ "	tk 31100-18	tk 31110-18		
2300 mm - 90 ¹ / ₂ "	tk 31100-23	tk 31110-23	tk 31120-23	tk 31130-23



	1.8 mm Ø	2.2 mm Ø	2.6 mm Ø	3.4 mm Ø
1200 mm - 47 ¹ / ₄ "	tk 31101-12	tk 31111-12		
1600 mm - 63"	tk 31101-16	tk 31111-16	tk 31121-16	tk 31131-16
1800 mm - 70 ³ / ₄ "	tk 31101-18	tk 31111-18		
2300 mm - 90 ¹ / ₂ "	tk 31101-23	tk 31111-23	tk 31121-23	tk 31131-23



	1.8 mm Ø	2.2 mm Ø	3.4 mm Ø
1200 mm - 47 ¹ / ₄ "	tk 31102-12	tk 31112-12	
1600 mm - 63"	tk 31102-16	tk 31112-16	tk 31132-16
1800 mm - 70 ³ / ₄ "	tk 31102-18	tk 31112-18	
2300 mm - 90 ¹ / ₂ "	tk 31102-23	tk 31112-23	tk 31132-23



	1.8 mm Ø	2.2 mm Ø	3.4 mm Ø
1200 mm - 47 ¹ / ₄ "	tk 31103-12	tk 31113-12	
1600 mm - 63"	tk 31103-16	tk 31113-16	tk 31133-16
1800 mm - 70 ³ / ₄ "	tk 31103-18	tk 31113-18	
2300 mm - 90 ¹ / ₂ "	tk 31103-23	tk 31113-23	tk 31133-23

Flexible Zangen
Flexible forceps

Pinces flexibles
Pinzas flexibles
Pinze flessibili



	1.8 mm Ø	2.2 mm Ø
1600 mm – 63"	tk 31140-16	tk 31150-16
2300 mm – 90½"	tk 31140-23	tk 31150-23



	1.8 mm Ø	2.2 mm Ø
1600 mm – 63"	tk 31142-16	tk 31152-16
2300 mm – 90½"	tk 31142-23	tk 31152-23



	1.8 mm Ø	2.2 mm Ø
1600 mm – 63"	tk 31143-16	tk 31153-16
2300 mm – 90½"	tk 31143-23	tk 31153-23

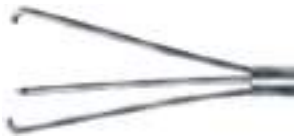

	1.8 mm Ø	2.2 mm Ø
1600 mm – 63"	tk 31146-16	tk 31156-16
2300 mm – 90½"	tk 31146-23	tk 31156-23



	1.8 mm Ø	2.2 mm Ø
1600 mm – 63"	tk 31147-16	tk 31157-16
2300 mm – 90½"	tk 31147-23	tk 31157-23

Hämorrhoidal-Zangen
Haemorrhoidal forceps

Pincas hémorroidales
Pinzas hemorroidales
 Pinze emorroidali

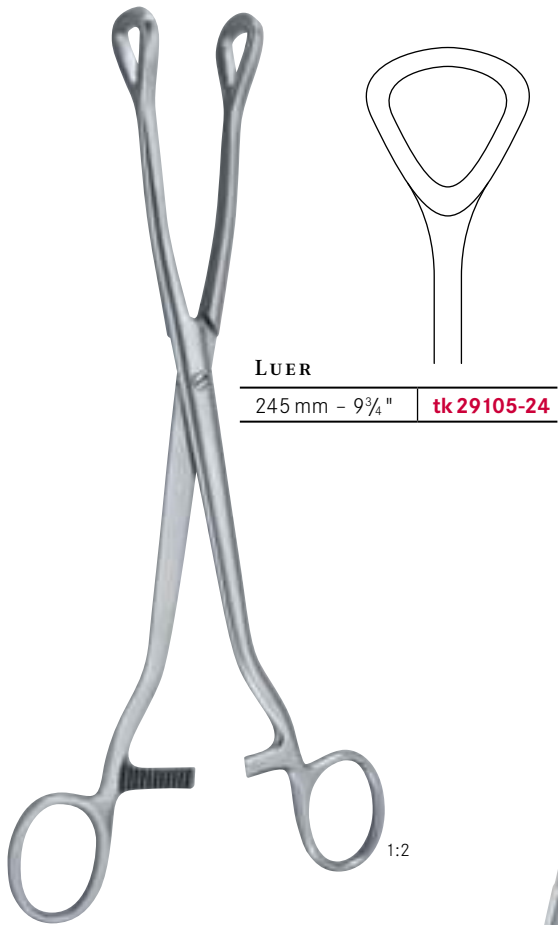

LUER

245 mm - 9¾" **tk29105-24**



MC GIVNEY

190 mm - 7½"

tk29111-19

1x gebogen
single curved
 courbé simple
curvado simple
 curvatura singola

tk29112-19

2x gebogen
double curved
 courbé double
curvado doble
 curvatura doppia

Polypenfasszangen
Polypus grasping forceps

Pinces pour saisir polypes
Pinzas para coger pólipos
Pinze per afferrare polipi



HEYWOOD-
SMITH

200 mm - 8"

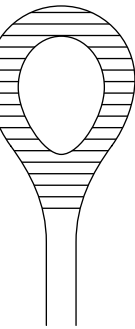

tk 29114-20

1:2



HEYWOOD-
SMITH

210 mm - 8¼"

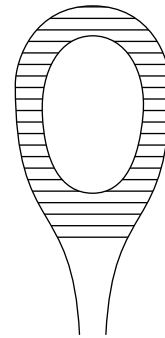

tk 29115-21

1:2

Hämorrhoidal-Ligatoren
Haemorrhoidal ligators

Ligateurs hémorroïdales
Ligadores hemorroidales
 Legatori emorroidali

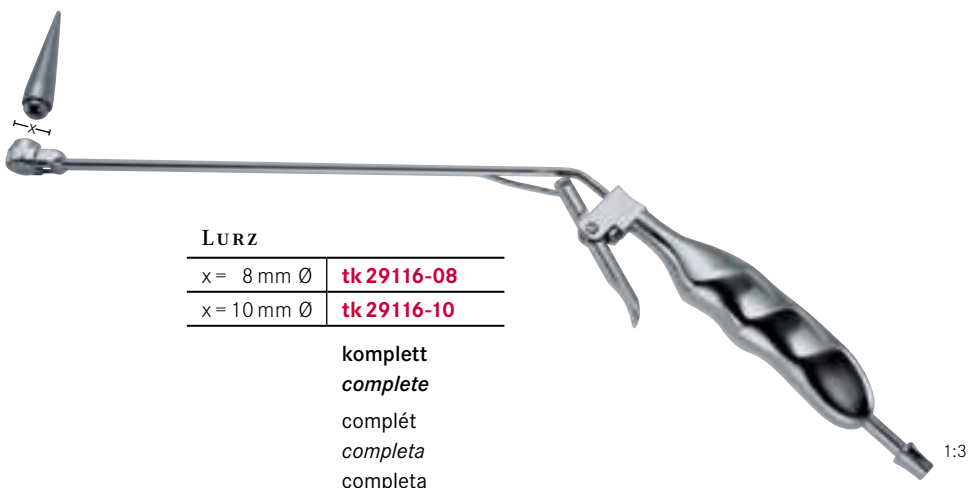

LURZ

x = 8 mm Ø	tk 29116-08
x = 10 mm Ø	tk 29116-10

komplett
complete
 complét
completa
 completa

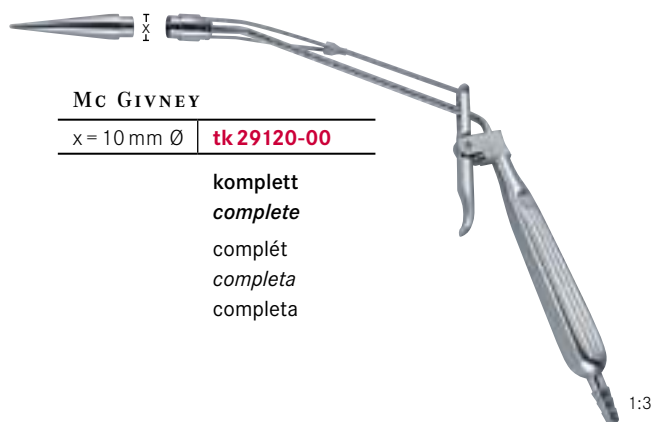

MC GIVNEY

x = 10 mm Ø	tk 29120-00
-------------	--------------------

komplett
complete
 complét
completa
 completa

tk 29140-00

Gummiringe, Packung à 100 Stück
Rubber rings, package of 100 pieces

Anneaux de caoutchouc à ligatures, paquet de 100 pièces
Anillos de goma para ligaduras, paquete de 100 piezas
 Anelli di gomma, pacchetto di 100 pezzi

Hämorrhoidal-Ligatoren
Haemorrhoidal ligators

Ligateurs hémorroïdales
Ligadores hemorroidales
Legatori emorroidali

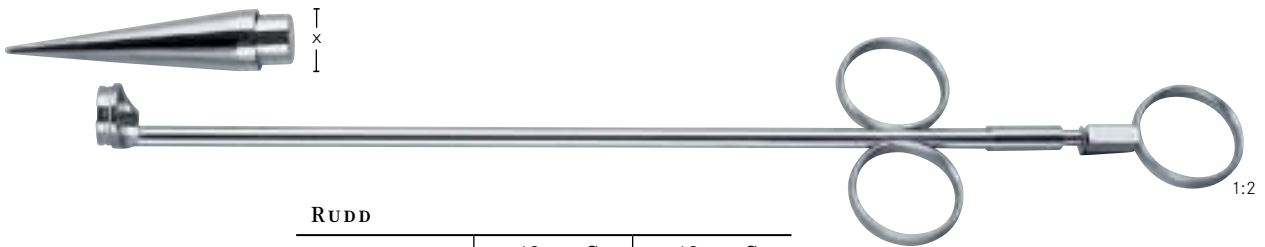

RUDD		
	x = 12 mm Ø	x = 12 mm Ø
315 mm - 12½"	tk 29130-00	tk 29130-01
	komplett <i>complete</i>	Ladekegel allein <i>Cone piece only</i>
	complét <i>completa</i>	Cône seule <i>Cono solo</i>
	completa	Cono solo

tk 29140-00

Gummiringe, Packung à 100 Stück
Rubber rings, package of 100 pieces

Anneaux de caoutchouc à ligatures, paquet de 100 pièces
Anillos de goma para ligaduras, paquete de 100 piezas
Anelli di gomma, pacchetto di 100 pezzi



Urologie
Urology

Urologie
Urología
Urologia



Nierensteinzangen
Kidney stone forceps

Pinces pour les calculs rénaux
Pinzas para cálculos renales
Pinze per calcoli renali

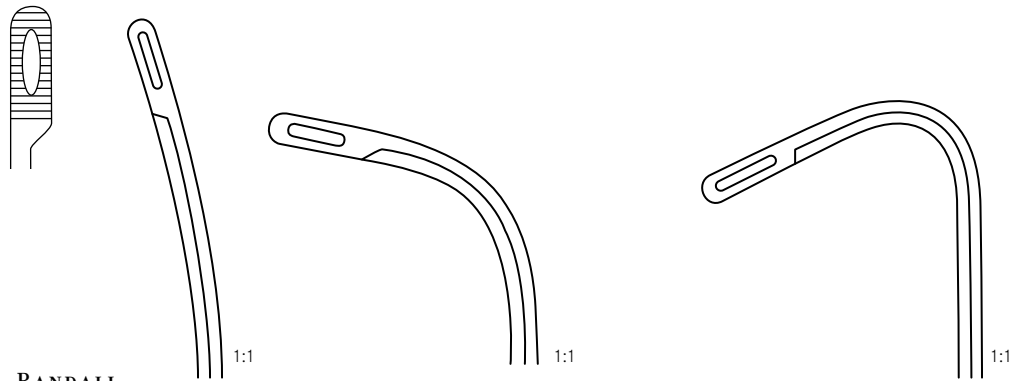

RANDALL

Fig. 1	Fig. 2	Fig. 3
230 mm - 9"	220 mm - 8 ³ / ₄ "	190 mm - 7 ¹ / ₂ "
tk 30221-23	tk 30222-22	tk 30223-22

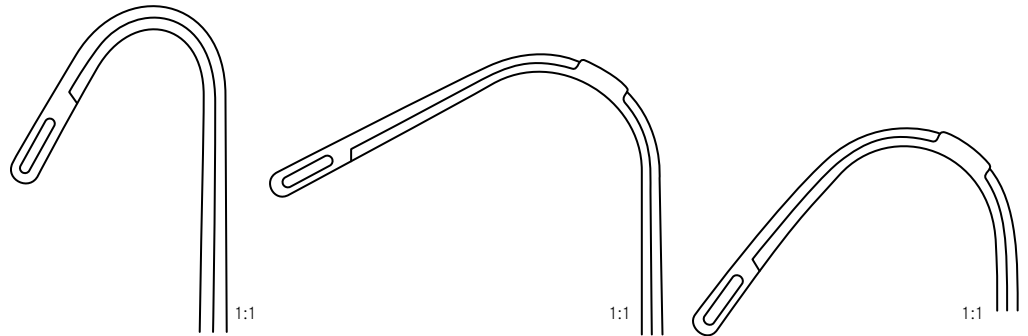

Fig. 4	Fig. 5	Fig. 6
190 mm - 7 ¹ / ₂ "	190 mm - 7 ¹ / ₂ "	190 mm - 7 ¹ / ₂ "
tk 30224-22	tk 30225-19	tk 30226-19

Gallenstein-Instrumente
Gall stone instruments

Instruments pour calculs biliaires
Instrumental para coger cálculos biliares
Strumenti per canali bilari



1:3

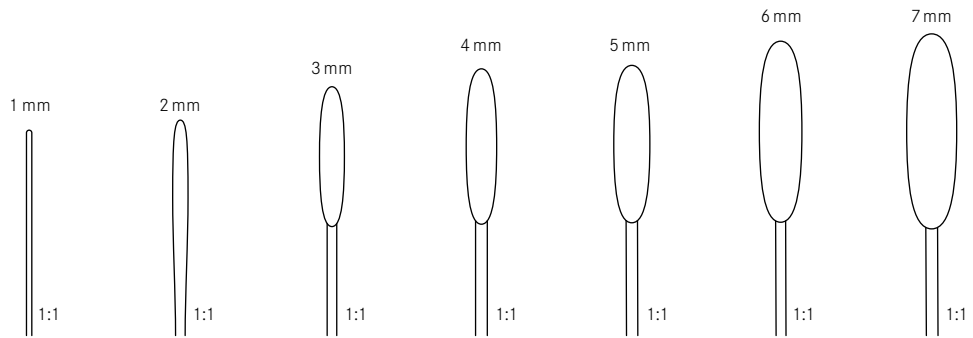

BAKES

	Fig. 1	Fig. 2	Fig. 3	Fig. 4	Fig. 5	Fig. 6	Fig. 7
300 mm - 12"	tk 30100-01	tk 30100-02	tk 30100-03	tk 30100-04	tk 30100-05	tk 30100-06	tk 30100-07

biegsam
malleable
malléable
maleable
flessibile

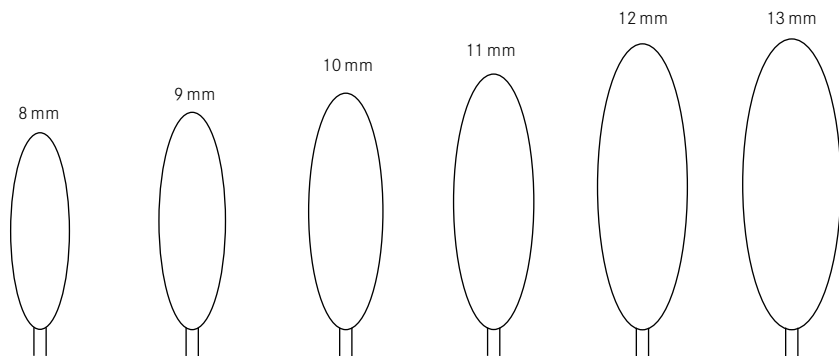
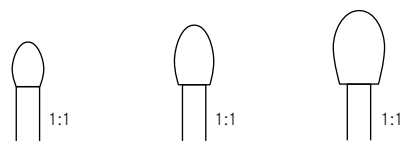

	Fig. 8	Fig. 9	Fig. 10	Fig. 11	Fig. 12	Fig. 13
300 mm - 12"	tk 30100-08	tk 30100-09	tk 30100-10	tk 30100-11	tk 30100-12	tk 30100-13

biegsam
malleable
malléable
maleable
flessibile



1:3



DESIARDINS

	Fig. 1	Fig. 2	Fig. 3
280 mm - 11"	tk 30260-01	tk 30260-02	tk 30260-03

federnd
elastic
élastique
elastica
elastico

Gallenstein-Instrumente
Gall stone instruments

Instruments pour calculs biliaires
Instrumental para coger cálculos biliares
Strumenti per canali bilari



1:3

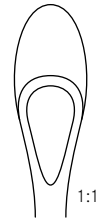
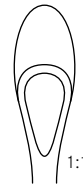
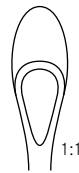

DESJARDINS

	Fig. 1	Fig. 2	Fig. 3	Fig. 4
300 mm - 12"	tk 30110-01	tk 30110-02	tk 30110-03	tk 30110-04

federnd
elastic
élastique
elastica
elastico



1:3

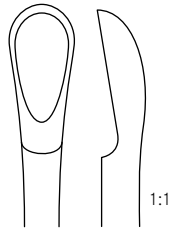

MOYNIHAN

	x = 5 mm
340 mm - 13 1/2"	tk 30258-34

biegsam
malleable
malléable
maleable
flessibile

Gallensteinlöffel
Gall stone scoops

Curettes pour calculs biliaires
Cucharillas para coger cálculos billares
Cucchiai per colcoli bilari



LUER-KOERTE

	Fig. 000	Fig. 00	Fig. 0	Fig. 1
320 mm - 12½"	tk 30285-01	tk 30285-02	tk 30285-03	tk 30285-04

biegsam, stumpf
malleable, blunt
malléable, mousse
maleable, roma
flessibile, smussa

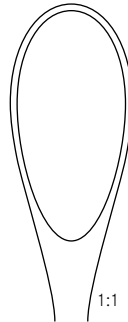
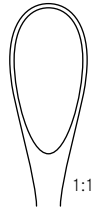

	Fig. 2	Fig. 3	Fig. 4	Fig. 5
320 mm - 12½"	tk 30285-05	tk 30285-06	tk 30285-07	tk 30285-08

biegsam, stumpf
malleable, blunt
malléable, mousse
maleable, roma
flessibile, smussa



MAYO

280 mm - 11"	tk 30290-28
--------------	--------------------

1:2

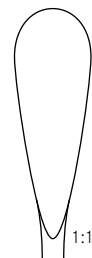

FERGUSSON

215 mm - 8½"	220 mm - 8¾"	235 mm - 9¼"
tk 30295-21	tk 30295-22	tk 30295-23

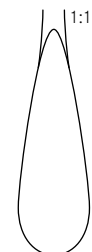

Gallenstein-Instrumente
Gall stone instruments

Instruments pour calculs biliaries
Instrumental para coger cálculos biliares
Strumenti per canali bilari

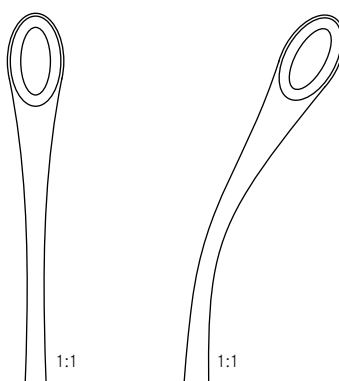
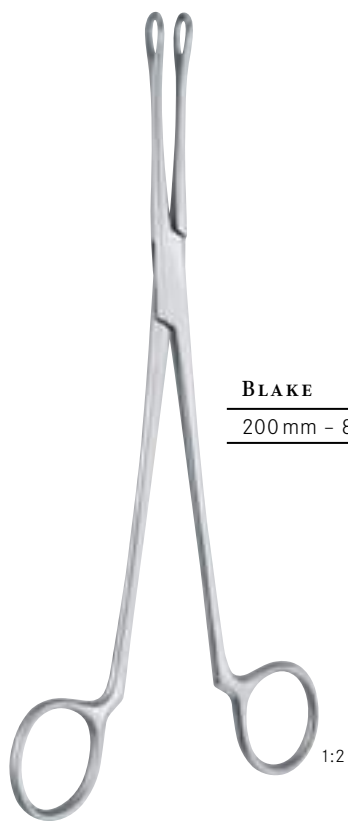

BLAKE

200 mm - 8"

tk 30200-20

tk 30201-20

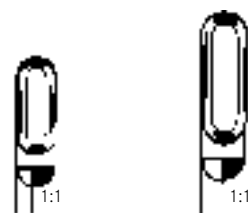

DESJARDINS

230 mm - 9"

tk 30210-23

tk 30212-23

Gallenstein-Instrumente
Gall stone instruments

Instruments pour calculs biliaires
Instrumental para coger cálculos biliares
Strumenti per canali bilari



CZERNY

245 mm - 9³/₄"

tk 30267-25



1:1



TURNER-
WARWICK

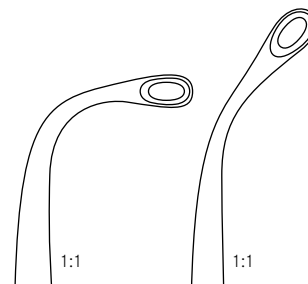

1:1

1:1

180 mm - 7"

190 mm - 7¹/₂"

tk 30265-18

tk 30265-19

Prostatahaken
Prostatic retractors

Ecarteurs prostatiques
Separadores para la próstata
Divaricatori prostatici



YOUNG

tk 30300-21 | 210 mm - 8 1/4"

1:2



YOUNG

tk 30302-22 | 220 mm - 8 3/4"

1:2



YOUNG

tk 30304-21 | 210 mm - 8 1/4"

1:2

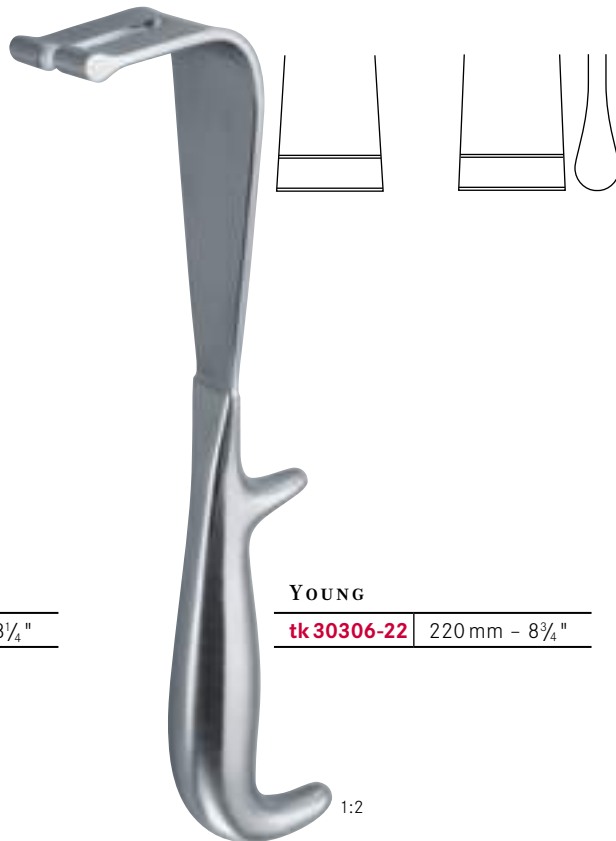

YOUNG

tk 30306-22 | 220 mm - 8 3/4"

1:2

Instrumente für Prostata-Operationen
Prostatectomy instruments

Instruments pour prostatectomie
Instrumentos para prostatectomía
Strumenti per operazioni della prostata

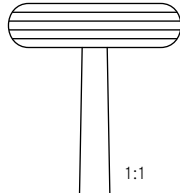

MILLIN

230 mm - 9"

tk 30320-23

Kapselfasszange zur retropubischen Prostatektomie
Capsule forceps for retropubic prostatectomy

Pince pour saisir les capsules pour la prostatectomie rétropubique
Pinza capsular para le prostatectomía retroúbica
Pinza a capsula per prostatectomia retropubica



MILLIN

230 mm - 9"

tk 30322-23

Fasszange für die vorderen Lappen
Prostatic lobe holding forceps

Pince pour saisir les lambeaux
Pinza para coger los lóbulos anteriores
Pinza da presa per lobo prostatico

1:2

Instrumente für Prostata-Operationen
Prostatectomy instruments

Instruments pour prostatectomie
Instrumentos para prostatectomía
Strumenti per operazioni della prostata

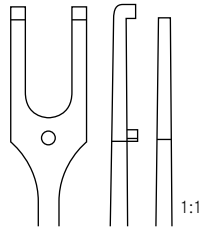

MILLIN

240 mm - 9½" tk 30324-24

Fadenführungszange
Ligatur carrying forceps

Pince porte-fil
Pinza porta-ligaduras
Pinza per fili di sutura

1:2



YOUNG

205 mm - 8" tk 30310-20

Prostata-Fasszange
Prostate holding forceps

Pince pour saisir la prostate
Pinza para coger la próstata
Pinza da presa per lobo prostatico

1:2

Blasenwundspreizer
Bladder retractors

Ecarteurs vésicaux
Separadores vesicales
Divaricatori vescicali



THOMSON-WALKER

tk 30335-00

komplett mit 2 Paar Seitenvlaven, 1 Mittelvalve
complete with 2 pairs of lateral blades, 1 central blade
complet, avec 2 paires de valves latérales, 1 valve centrale
completo con 2 pares de valvas laterales, 1 valva central
completo, con 2 paia di valve laterali, 1 valva centrale



MILLIN

		57 mm x 25 mm	80 mm x 25 mm	120 mm x 45 mm
tk 30352-00	tk 30352-10	tk 30352-11	tk 30352-12	tk 30352-13
komplett	Sperrer, allein	2 Blätter	2 Blätter	1 Mittelblatt
complete	Spreader, only	2 Blades	2 Blades	1 Center blade
complet	Retracteur, seul	2 Valves	2 Valves	1 Valve centrale
completa	Retractor, solo	2 Valvas	2 Valvas	1 Valva central
completa	Divaricatore, solo	2 Valve	2 Valve	1 Valva centrale

tk 30352-01

komplett mit Kaltlichtaufsatz
complete with cold light carrier
complet avec guide de lumière froide
completa con guía de luz fría
completa con portaluze fredda

tk 30352-02

Kaltlichtaufsatz
Cold light carrier

Guide de lumière froide
Guía de luz fría
Porta luce fredda, solo

Blasenwundspreizer
Bladder retractors

Ecarteurs vésicaux
Separadores vesicales
Divaricatori vescicali



LEGUEU
tk 30336-00

1:3



JUDD-MASSON
tk 30350-00

1:3



LEGUEU

1:3

	x = 35 mm
270 mm - 10 3/4"	tk 30361-27



KOCHER

1:3

	x = 67 mm
260 mm - 10 1/4"	tk 30363-26



MILLIN

1:3

	285 mm - 11 1/4"
	tk 30331-00

Dilatationsbougies
Dilating bougies

Bougies dilatatrices
Bujías dilatadoras
Candelette dilatatrici

DITTEL

		220 mm - 8 3/4"
2 2/3 mm Ø	8 Charr./Fr.	tk 30390-08
3 mm Ø	9 Charr./Fr.	tk 30390-09
3 1/3 mm Ø	10 Charr./Fr.	tk 30390-10
3 2/3 mm Ø	11 Charr./Fr.	tk 30390-11
4 mm Ø	12 Charr./Fr.	tk 30390-12
4 1/3 mm Ø	13 Charr./Fr.	tk 30390-13
4 2/3 mm Ø	14 Charr./Fr.	tk 30390-14
5 mm Ø	15 Charr./Fr.	tk 30390-15
5 1/3 mm Ø	16 Charr./Fr.	tk 30390-16
5 2/3 mm Ø	17 Charr./Fr.	tk 30390-17
6 mm Ø	18 Charr./Fr.	tk 30390-18
6 1/3 mm Ø	19 Charr./Fr.	tk 30390-19
6 2/3 mm Ø	20 Charr./Fr.	tk 30390-20
7 mm Ø	21 Charr./Fr.	tk 30390-21
7 1/3 mm Ø	22 Charr./Fr.	tk 30390-22
7 2/3 mm Ø	23 Charr./Fr.	tk 30390-23
8 mm Ø	24 Charr./Fr.	tk 30390-24
8 1/3 mm Ø	25 Charr./Fr.	tk 30390-25
8 2/3 mm Ø	26 Charr./Fr.	tk 30390-26
9 mm Ø	27 Charr./Fr.	tk 30390-27
9 1/3 mm Ø	28 Charr./Fr.	tk 30390-28
9 2/3 mm Ø	29 Charr./Fr.	tk 30390-29
10 mm Ø	30 Charr./Fr.	tk 30390-30
10 2/3 mm Ø	32 Charr./Fr.	tk 30390-32
11 mm Ø	33 Charr./Fr.	tk 30390-33
11 1/3 mm Ø	34 Charr./Fr.	tk 30390-34
12 mm Ø	36 Charr./Fr.	tk 30390-36

gerade
straight

droit
recta
rette

DITTEL

		350 mm - 13 3/4"
2 2/3 mm Ø	8 Charr./Fr.	tk 30392-08
3 mm Ø	9 Charr./Fr.	tk 30392-09
3 1/3 mm Ø	10 Charr./Fr.	tk 30392-10
3 2/3 mm Ø	11 Charr./Fr.	tk 30392-11
4 mm Ø	12 Charr./Fr.	tk 30392-12
4 1/3 mm Ø	13 Charr./Fr.	tk 30392-13
4 2/3 mm Ø	14 Charr./Fr.	tk 30392-14
5 mm Ø	15 Charr./Fr.	tk 30392-15
5 1/3 mm Ø	16 Charr./Fr.	tk 30392-16
5 2/3 mm Ø	17 Charr./Fr.	tk 30392-17
6 mm Ø	18 Charr./Fr.	tk 30392-18
6 1/3 mm Ø	19 Charr./Fr.	tk 30392-19
6 2/3 mm Ø	20 Charr./Fr.	tk 30392-20
7 mm Ø	21 Charr./Fr.	tk 30392-21
7 1/3 mm Ø	22 Charr./Fr.	tk 30392-22
7 2/3 mm Ø	23 Charr./Fr.	tk 30392-23
8 mm Ø	24 Charr./Fr.	tk 30392-24
8 1/3 mm Ø	25 Charr./Fr.	tk 30392-25
8 2/3 mm Ø	26 Charr./Fr.	tk 30392-26
9 mm Ø	27 Charr./Fr.	tk 30392-27
9 1/3 mm Ø	28 Charr./Fr.	tk 30392-28
9 2/3 mm Ø	29 Charr./Fr.	tk 30392-29
10 mm Ø	30 Charr./Fr.	tk 30392-30
10 2/3 mm Ø	32 Charr./Fr.	tk 30392-32
11 mm Ø	33 Charr./Fr.	tk 30392-33
11 1/3 mm Ø	34 Charr./Fr.	tk 30392-34
12 mm Ø	36 Charr./Fr.	tk 30392-36

gebogen
curved

courbe
curva
curve

1:2

1:2

Dilationsbougies | **Bougies dilatatrices**
Dilating bougies | **Bujías dilatadoras**
Candelette dilatatrici



VAN BUREN

2½ mm Ø	8 Charr./Fr.	tk 30391-08
3½ mm Ø	10 Charr./Fr.	tk 30391-10
4 mm Ø	12 Charr./Fr.	tk 30391-12
4½ mm Ø	14 Charr./Fr.	tk 30391-14
5½ mm Ø	16 Charr./Fr.	tk 30391-16
6 mm Ø	18 Charr./Fr.	tk 30391-18
6½ mm Ø	20 Charr./Fr.	tk 30391-20
7½ mm Ø	22 Charr./Fr.	tk 30391-22
8 mm Ø	24 Charr./Fr.	tk 30391-24
8½ mm Ø	26 Charr./Fr.	tk 30391-26
9½ mm Ø	28 Charr./Fr.	tk 30391-28
10 mm Ø	30 Charr./Fr.	tk 30391-30
10½ mm Ø	32 Charr./Fr.	tk 30391-32
11½ mm Ø	34 Charr./Fr.	tk 30391-34
12 mm Ø	36 Charr./Fr.	tk 30391-36

VAN BUREN
tk 30391-00

Satz, Fig. 08 - Fig. 36
 Set, Fig. 08 - Fig. 36
 Jeu, Fig. 08 - Fig. 36
 Juego, Fig. 08 - Fig. 36
 Serie, Fig. 08 - Fig. 36



GUYON

3½ mm Ø	10 Charr./Fr.	tk 30393-10
3½ mm Ø	11 Charr./Fr.	tk 30393-11
4 mm Ø	12 Charr./Fr.	tk 30393-12
4½ mm Ø	13 Charr./Fr.	tk 30393-13
4½ mm Ø	14 Charr./Fr.	tk 30393-14
5 mm Ø	15 Charr./Fr.	tk 30393-15
5½ mm Ø	16 Charr./Fr.	tk 30393-16
5½ mm Ø	17 Charr./Fr.	tk 30393-17
6 mm Ø	18 Charr./Fr.	tk 30393-18
6½ mm Ø	19 Charr./Fr.	tk 30393-19
6½ mm Ø	20 Charr./Fr.	tk 30393-20
7 mm Ø	21 Charr./Fr.	tk 30393-21
7½ mm Ø	22 Charr./Fr.	tk 30393-22
7½ mm Ø	23 Charr./Fr.	tk 30393-23
8 mm Ø	24 Charr./Fr.	tk 30393-24
8½ mm Ø	25 Charr./Fr.	tk 30393-25
8½ mm Ø	26 Charr./Fr.	tk 30393-26
9 mm Ø	27 Charr./Fr.	tk 30393-27
9½ mm Ø	28 Charr./Fr.	tk 30393-28
9½ mm Ø	29 Charr./Fr.	tk 30393-29
10 mm Ø	30 Charr./Fr.	tk 30393-30

GUYON
tk 30393-00

Satz, Fig. 10 - Fig. 30, ohne Innengewinde
 Set, Fig. 10 - Fig. 30, without inner thread
 Jeu, Fig. 10 - Fig. 30, sans filet intérieur
 Juego, Fig. 10 - Fig. 30, sin filete interior
 Serie, Fig. 10 - Fig. 30, senza filetto interno

Metallkatheter für Frauen
Metal catheters for women

Sondes métalliques pour femmes
 Sondas metálicas para mujeres
 Sonde metalliche per donne



GUYON

2 mm Ø	6 Charr./Fr.	tk 30410-06
2½ mm Ø	7 Charr./Fr.	tk 30410-07
2½ mm Ø	8 Charr./Fr.	tk 30410-08
3 mm Ø	9 Charr./Fr.	tk 30410-09
3½ mm Ø	10 Charr./Fr.	tk 30410-10
3½ mm Ø	11 Charr./Fr.	tk 30410-11
4 mm Ø	12 Charr./Fr.	tk 30410-12
4½ mm Ø	13 Charr./Fr.	tk 30410-13
4½ mm Ø	14 Charr./Fr.	tk 30410-14
5 mm Ø	15 Charr./Fr.	tk 30410-15
5½ mm Ø	16 Charr./Fr.	tk 30410-16
5½ mm Ø	17 Charr./Fr.	tk 30410-17
6 mm Ø	18 Charr./Fr.	tk 30410-18
6½ mm Ø	19 Charr./Fr.	tk 30410-19
6½ mm Ø	20 Charr./Fr.	tk 30410-20
7 mm Ø	21 Charr./Fr.	tk 30410-21
7½ mm Ø	22 Charr./Fr.	tk 30410-22
7½ mm Ø	23 Charr./Fr.	tk 30410-23
8 mm Ø	24 Charr./Fr.	tk 30410-24

Dilationsbougies
Dilating bougies

Bougies dilatatrices
Bujías dilatadoras
Candelette dilatatrici

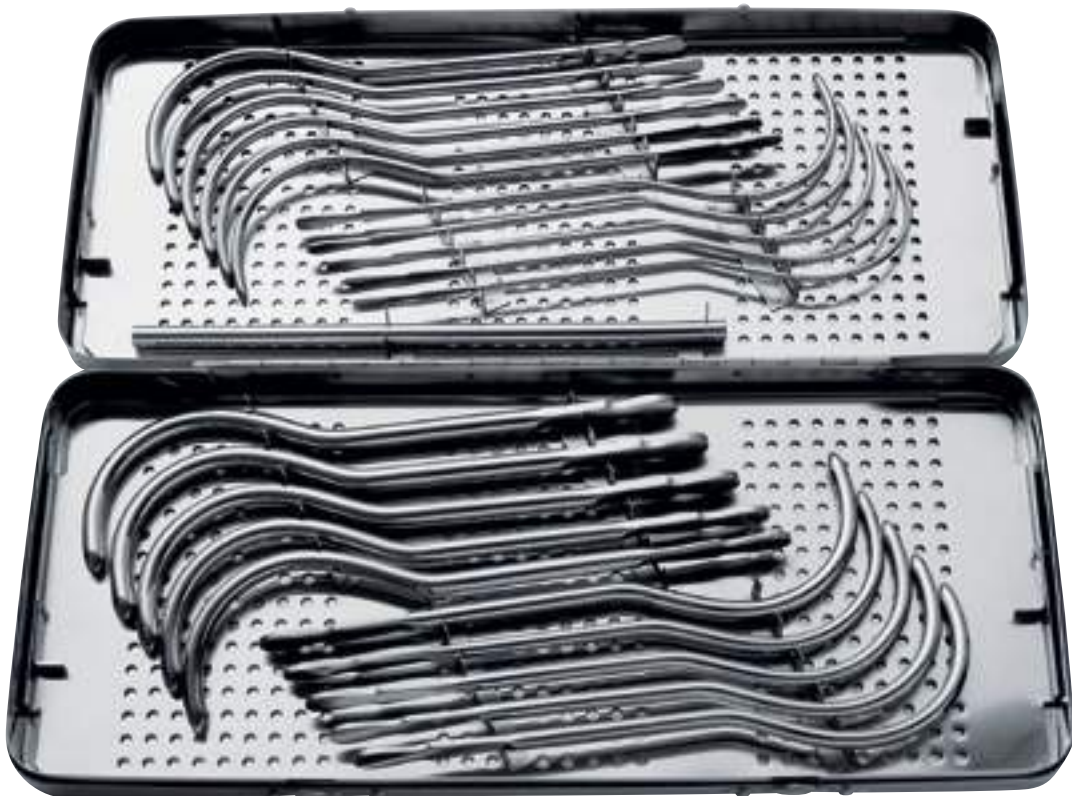

GUYON

420 mm x 175 mm x 40 mm

tk 30398-00

komplett, Charr. 10 - 30, im Edelstahl-Etui
complete, Charr. 10 - 30, in steel case

complet, Charr. 10 - 30, en étui métallique
completa, Charr. 10 - 30, en caja metálica

completa, Charr. 10 - 30, in astuccio metallico

Urethrotom <i>Urethrotome</i>	Urétrotome <i>Uretrótomo</i> Uretrotomi
---	--

**OTIS****tk 30423-00**

komplett, im Holzetui
 mit Dilatator, 2 Messern und 3 Ansätzen
complete in wooden case
with dilator, 2 knives and 3 tips
 complet, en boîte de bois
 avec dilateur, 2 lames et 3 embouts
completo en caja de madera
con dilatador, 2 cuchillos y 3 puntas
 completo, in contenitore di legno
 con dilatatore, 2 bisturi e 3 punte

tk 30424-00

Ersatzmesser
Spare blade
 Lame de rechange
Hoja de cambio
 Lama di ricambio



Urologie-Instrumente
Instruments for urology

Instruments pour l'urologie
Instrumentos para la urología
Strumenti per urologia

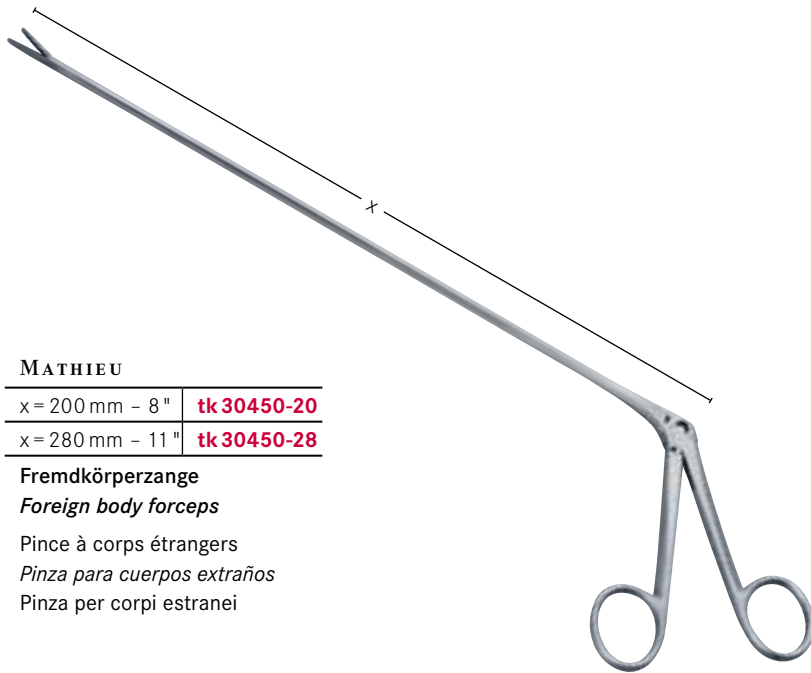

MATHIEU

x = 200 mm - 8" **tk 30450-20**

x = 280 mm - 11" **tk 30450-28**

Fremdkörperzange

Foreign body forceps

Pince à corps étrangers

Pinza para cuerpos extraños

Pinza per corpi estranei



160 mm - 6¼" **tk 17011-16**

Samenstrang-Haken

Hook for the spermatic cord

Crochet pour le cordon spermatique

1:2 *Grancho para el cordón espermático*

Uncino per dotto spermatico



GUYON

390 mm - 15½" **tk 30444-39**

350 mm - 13¾" **tk 30445-35**

Katheterspanner

Mandrin for rubber catheters

Mandrin pour cathéters

Mandril para catéteres

Introduttore per catheteri



145 mm - 5¾" **tk 30467-14**

zum Fixieren des Samenstranges

Fixation clamp for the spermatic cord

Pince à vis pour fixation du cordon spermatique

Pinza con rosca para fijación el cordon espermático

Pinza con vite per fissare il funicolo spermatico

Beschneidungsinstrumente
Circumcision instruments

Instrumentos de circuncision
Instrumentos para circuncisión
Strumenti per circuncisione



8 mm Ø	tk 30456-08
11 mm Ø	tk 30456-11
13 mm Ø	tk 30456-13
16 mm Ø	tk 30456-16
21 mm Ø	tk 30456-21
26 mm Ø	tk 30456-26
32 mm Ø	tk 30456-32



75 mm - 3"	tk 30458-00
------------	--------------------

Beschneidungsklemme
Circumcision instrument

Instrument de circuncision
Instrumento para circuncisión
Strumento di circuncisione

Beschneidungsklemme
Circumcision instrument

Instrument de circuncision
Instrumento para circuncisión
Strumento di circuncisione



140 mm - 5½"	tk 30471-14	tk 30472-14
--------------	--------------------	--------------------

Vasectomieklemmen
Vasectomy clamps

Pinza para Vasectomia
Pince pour Vasectomie
Pinza per vasectomia

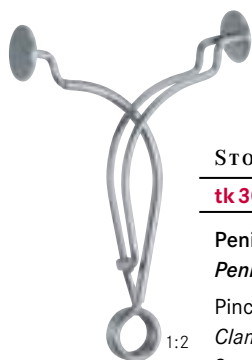

STOCKMANN
tk 30460-08

Penisklemme
Penis clamp
Pince pour le pénis
Clamp para el pene
Serrapene



STRAUSS
tk 30465-11

Penisklemme
Penis clamp
Pince pour le pénis
Clamp para el pene
Serrapene



Gynäkologie
Gynecology

Gynécologie
Ginecología
Ginecologia



Scheidenspekula
Vaginal specula

Spéculums vaginaux
Espéculos vaginales
Specoli vaginali



Standard Scheidenspekula

Standard Vaginal specula

Standard Spéculum vaginaux

Standard Espéculos vaginales

standard Specoli vaginali



isoliert - für HF-Chirurgie mit Rauchabsaugung

insulated - for HF Surgery (Radio Frequency), with smoke evacuation

isolés - pour la chirurgie à haute fréquence, avec aspiration de la fumée

Aislados - para la cirugía por alta frecuencia, con aspiración de humo

Isolati - per la chirurgia ad alta frequenza, con aspirazione di fumo



Antireflex - für Laser-Chirurgie mit Rauchabsaugung

Antireflex - for Laser Surgery (Radio Frequency), with smoke evacuation

Antireflexe - pour la chirurgie au laser, avec aspiration de la fumée

Antireflejos - para la cirugía por laser, con aspiración de humo

Antiriflesso - per la chirurgia laser, con aspirazione di fumo



Scheidenspekula
Vaginal specula

Spéculums vaginaux
Espéculos vaginales
Specoli vaginali



Cusco



75 mm x 32 mm	tk 34001-01	tk 34001-51	tk 34001-61
85 mm x 35 mm	tk 34001-02	tk 34001-52	tk 34001-62
100 mm x 35 mm	tk 34001-03	tk 34001-53	tk 34001-63

75 mm x 17 mm	tk 34005-04	-	-
---------------	--------------------	---	---

für Jungfrauen
for virgins

pour vierges
para virgenes
per vergine



Cusco



75 mm x 32 mm	tk 34007-01
85 mm x 35 mm	tk 34007-02
100 mm x 37 mm	tk 34007-03

Scheidenspekula
Vaginal specula

Spéculums vaginaux
Espéculos vaginales
Specoli vaginali

Cusco	<input type="checkbox"/>
80 mm x 22 mm	tk 34012-01
100 mm x 25 mm	tk 34012-02
105 mm x 27 mm	tk 34012-03

Schweizer Modell
Swiss pattern
Modèle suisse
Modelo suizo
Modello svizzero



GRAVE	<input type="checkbox"/>	<input checked="" type="checkbox"/>	<input type="checkbox"/>
75 mm x 20 mm	tk 34015-01	tk 34015-53	tk 34015-61
95 mm x 35 mm	tk 34015-02	tk 34015-52	tk 34015-62
115 mm x 35 mm	tk 34015-03	tk 34015-51	tk 34015-63

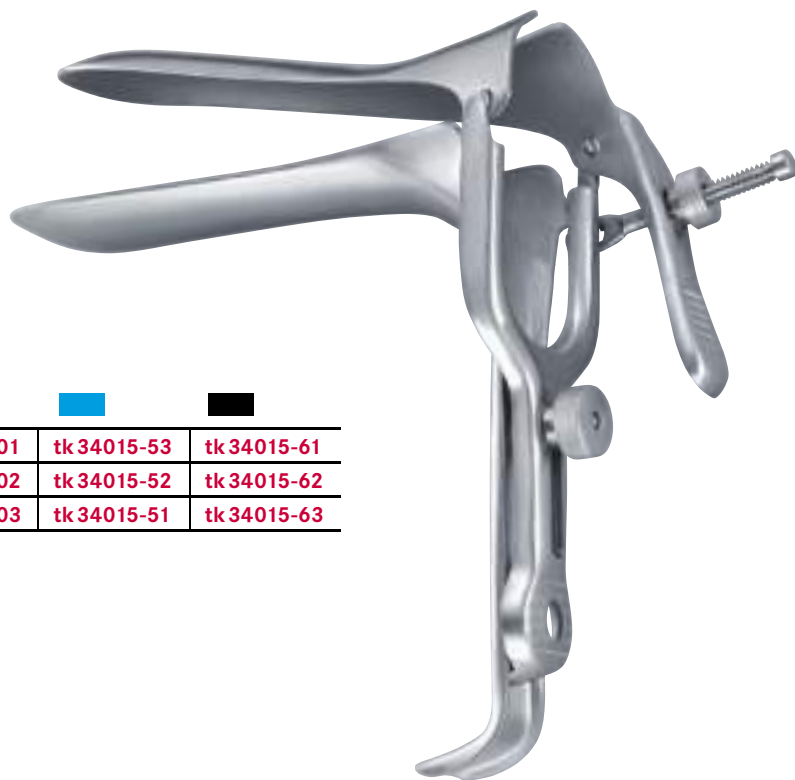

Scheidenspekula
Vaginal specula

Spéculums vaginaux
Espéculos vaginales
Specoli vaginali

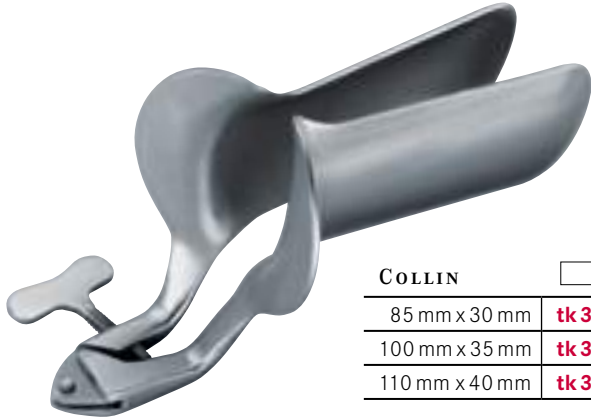

COLLIN	<input type="checkbox"/>	<input type="checkbox"/>	<input type="checkbox"/>
85 mm x 30 mm	tk 34018-01	tk 34018-53	tk 34018-61
100 mm x 35 mm	tk 34018-02	tk 34018-52	tk 34018-62
110 mm x 40 mm	tk 34018-03	tk 34018-51	tk 34018-63



SEMM	<input type="checkbox"/>
90 mm x 14 / 18 mm	tk 34020-00
100 mm x 17 / 20 mm	tk 34020-01
100 mm x 25 / 30 mm	tk 34020-02



TRELAT	<input type="checkbox"/>
85 mm x 30 mm	tk 34030-01
95 mm x 35 mm	tk 34030-02
115 mm x 43 mm	tk 34030-03



PEDERSON	<input type="checkbox"/>
75 mm x 13 mm	tk 34032-01
100 mm x 22 mm	tk 34032-02
120 mm x 25 mm	tk 34032-03

Scheidenspekula
Vaginal specula

Spéculums vaginaux
Espéculos vaginales
Specoli vaginali



KRISTELLER

70 mm x 27 mm	tk 34050-01
80 mm x 30 mm	tk 34050-02
90 mm x 36 mm	tk 34050-03
110 mm x 27 mm	tk 34050-04
110 mm x 30 mm	tk 34050-05
110 mm x 36 mm	tk 34050-06

Spekulum
Speculum
Spéculum
Espéculo
Specolo



75 mm x 23 mm	tk 34051-01
85 mm x 26 mm	tk 34051-02
100 mm x 32 mm	tk 34051-03
115 mm x 23 mm	tk 34051-04
115 mm x 26 mm	tk 34051-05
115 mm x 32 mm	tk 34051-06

Halter
Retractor
Valve
Valva
Valve



tk 34052-01
tk 34052-02
tk 34052-03
tk 34052-04
tk 34052-05
tk 34052-06

Satz
Set
Jeu
Juego
Serie

Scheidenspekula
Vaginal specula

Spéculums vaginaux
Espéculos vaginales
Specoli vaginali



KRISTELLER

105mm x 18 mm	tk 34055-01
105 mm x 21 mm	tk 34055-02

Spekulum konisch, für Jungfrauen
Speculum tapered, for virgins
Spéculum conique, pour vierges
Espéculo conico, para virgenes
Specolo conico, per virgini



110 mm x 14 mm	tk 34056-01
115 mm x 17 mm	tk 34056-02

Halter
Retractor
Valve
Valva
Valve



tk 34057-01
tk 34057-02

Satz
Set
Jeu
Juego
Serie

Scheidenspekula
Vaginal specula

Spéculums vaginaux
Espéculos vaginales
Specoli vaginali



JACKSON

75 mm x 35 mm	tk 34070-10
75 mm x 40 mm	tk 34070-15
90 mm x 35 mm	tk 34070-20
90 mm x 40 mm	tk 34070-25
100 mm x 35 mm	tk 34070-30
100 mm x 40 mm	tk 34070-35



AUVARD

220 mm - 8 3/4"
80 mm x 38 mm
tk 34060-00

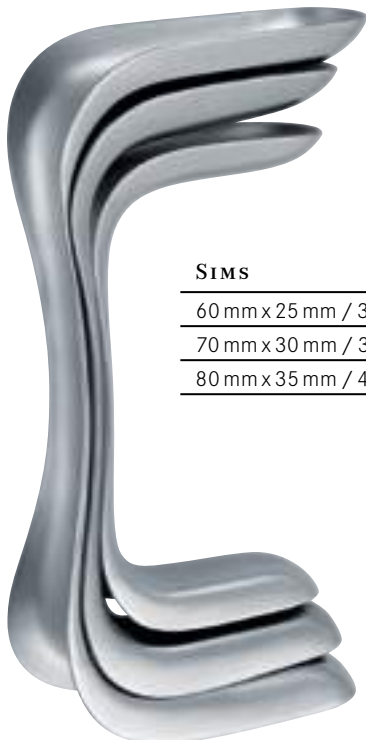

SIMS

60 mm x 25 mm / 30 mm	tk 34075-01
70 mm x 30 mm / 35 mm	tk 34075-02
80 mm x 35 mm / 40 mm	tk 34075-03

Scheidenspekula
Vaginal specula

Spéculums vaginaux
Espéculos vaginales
Specoli vaginali



KALLMORGEN

70 mm x 40 mm	tk 34072-01
90 mm x 40 mm	tk 34072-02

Spekulum
Speculum

Spéculum
Espéculo
Specolo



70 mm x 33 mm	tk 34073-01
90 mm x 33 mm	tk 34073-02

Halter
Retractor

Valve
Valva
Valve



tk 34074-01
tk 34074-02

Satz
Set

Jeu
Juego
Serie

Scheidenspekula
Vaginal specula

Spéculums vaginaux
Espéculos vaginales
Specoli vaginali



LANDAU

	290 mm - 11½"
100 mm x 28 mm	tk 34128-01
110 mm x 38 mm	tk 34128-02

BREISKY

	320 mm - 12¾"
130 mm x 20 mm	tk 34130-20
130 mm x 25 mm	tk 34130-25
130 mm x 30 mm	tk 34130-30
130 mm x 35 mm	tk 34130-35
130 mm x 40 mm	tk 34130-40

	300 mm - 12"
100 mm x 20 mm	tk 34142-20
100 mm x 25 mm	tk 34142-25
100 mm x 30 mm	tk 34142-30
100 mm x 35 mm	tk 34142-35
100 mm x 40 mm	tk 34142-40

	350 mm - 13¾"
160 mm x 40 mm	tk 34140-40
180 mm x 40 mm	tk 34140-41

Wiener Modell
Vienna pattern

Modèle Vienne
Modelo Vienna
Modello Vienna

Scheidenspekula
Vaginal specula

Spéculums vaginaux
Espéculos vaginales
Specoli vaginali



Fig. 1	Fig. 2	Fig. 3	Fig. 4	Fig. 5
80 mm x 30 mm	85 mm x 35 mm	90 mm x 40 mm	55 mm x 40 mm / 60 mm	70 mm x 45 mm / 70 mm
tk 34090-01	tk 34090-02	tk 34090-03	tk 34090-04	tk 34090-05

SCHERBACK

tk 34090-00

Satz (Fig. 1-Fig. 2) mit 400 g Gewicht (tk 34090-10)
Set (Fig. 1 - Fig. 2) with weight 400 grs. (tk 34090-10)

Jeu (Fig. 1 - Fig. 2) avec poids 400 gr. (tk 34090-10)
Juego (Fig. 1 - Fig. 2) con peso 400 gr. (tk 34090-10)
Serie (Fig. 1 - Fig. 2) con peso di 400 gr. (tk 34090-10)



400 g	tk 34090-10
600 g	tk 34090-11
800 g	tk 34090-12



tk 34090-14



DOYEN

	240 mm - 9 1/2"
55 mm x 35 mm	tk 34100-01
85 mm x 35 mm	tk 34100-02
115 mm x 35 mm	tk 34100-03
55 mm x 45 mm	tk 34102-01
85 mm x 45 mm	tk 34102-02
115 mm x 45 mm	tk 34102-03
160 mm x 45 mm	tk 34102-04
55 mm x 60 mm	tk 34104-01
85 mm x 60 mm	tk 34104-02
115 mm x 60 mm	tk 34104-03
160 mm x 60 mm	tk 34104-04

leichthohl
slightly concave
légèrement concave
ligeramente concava
legermente concavo

Endospekula
Endospecula

Endospéculums
Endospéculos
Endospecoli



KOGAN

240 mm - 9½" | **tk 34153-24**

mit Skalensperre und Stellschraube
with scale-ratchet and fixation screw

avec crémaillère à échelle et vis à fixation
con cremallera graduada y tornillo fijación
con cremagliera graduata e vite di fissaggio



KOGAN-MODIF.

280 mm - 11"

x = 4 mm y = 8 mm | **tk 34150-01**

x = 2 mm y = 4 mm | **tk 34150-02**

Parametriumklemmen
Parametrium forceps

Pinces parametrium
Pinzas parametrium
Pinze parametrium

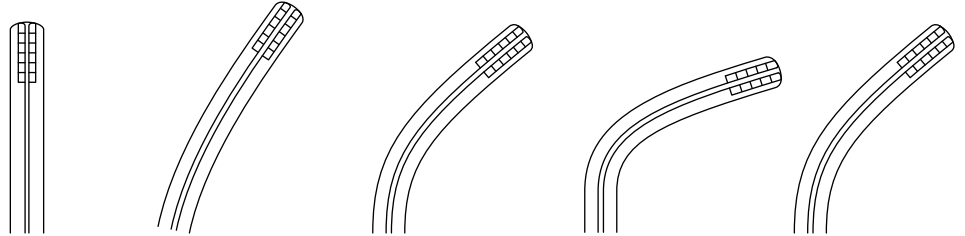
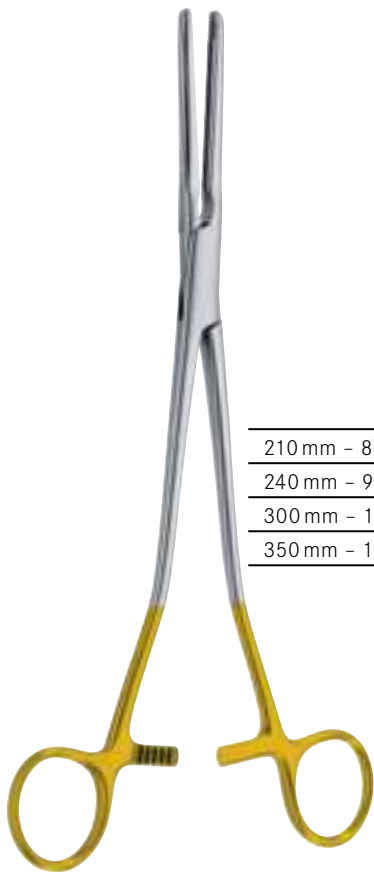

210 mm - 8 1/4"	tk 34155-21	tk 34156-21	tk 34157-21	tk 34158-21	tk 34159-21
240 mm - 9 1/2"	tk 34155-24	tk 34156-24	tk 34157-24	tk 34158-24	tk 34159-24
300 mm - 12"	tk 34155-30	tk 34156-30	tk 34157-30	tk 34158-30	tk 34159-30
350 mm - 13 3/4"	tk 34155-35	tk 34156-35	tk 34157-35	tk 34158-35	tk 34159-35

S-förmig gebogen
S-curved
coube en S
curva en S
curva a forma di S

Hysterektomieklemmen
Hysterectomy forceps

Pinces à hystérectomie
Pinzas-clamps para hysterectomia
Pinze per isterectomia

ATRAUMTK



ROGERS

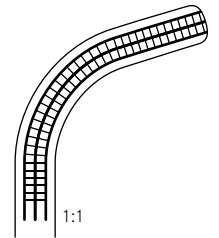
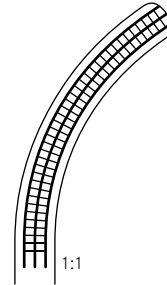
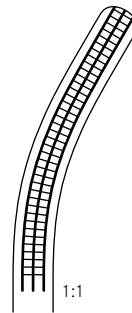
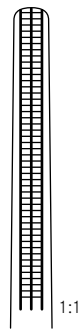

Fig. 1	Fig. 2	Fig. 3	Fig. 4
220 mm - 8 ³ / ₄ "	215 mm - 8 ¹ / ₂ "	210 mm - 8 ¹ / ₄ "	205 mm - 8"
tk 34147-01	tk 34147-02	tk 34147-03	tk 34147-04

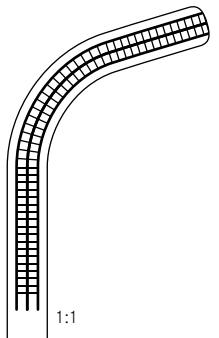
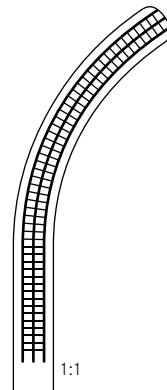
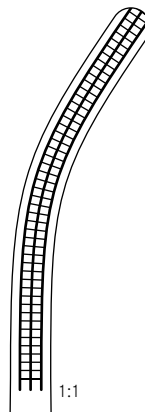
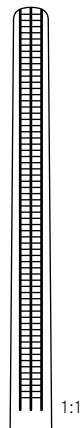

Fig. 1	Fig. 2	Fig. 3	Fig. 4
250 mm - 9 ³ / ₄ "	250 mm - 9 ³ / ₄ "	245 mm - 9 ³ / ₄ "	230 mm - 9"
tk 34148-01	tk 34148-02	tk 34148-03	tk 34148-04

Uterus-Sonden
Uterine sounds

Hystéromètres du col de l'utérus
Histerómetros uterinos
Isterometri uterini



1:2

VALLEIX250 mm - 9¾" **tk 34197-25**

graduiert, mit Schieber
graduated, with slider
graduado, avec curseur
graduado, con cursor
graduato, con cursore

**MARTIN**320 mm - 12½" **tk 34198-32** **tk 34199-32**

fest	biegsam
<i>rigid</i>	<i>malleable</i>
rigide	malléable
<i>rigido</i>	<i>maleable</i>
rigido	malleabile

**SIMS**320 mm - 12½" **tk 34200-32** **tk 34201-32**

fest	biegsam
<i>rigid</i>	<i>malleable</i>
rigide	malléable
<i>rigido</i>	<i>maleable</i>
rigido	malleabile

Uterus-Dilatatoren
Uterine dilators

Dilatateurs du col de l'utérus
Dilatadores uterinos
Dilatatori uterini



HEGAR

1.0 mm Ø	tk 34250-10
1.5 mm Ø	tk 34250-15
2.0 mm Ø	tk 34250-20
2.5 mm Ø	tk 34250-25
3.0 mm Ø	tk 34250-30
3.5 mm Ø	tk 34250-35
4.0 mm Ø	tk 34250-40
4.5 mm Ø	tk 34250-45
5.0 mm Ø	tk 34250-50
5.5 mm Ø	tk 34250-55
6.0 mm Ø	tk 34250-60
6.5 mm Ø	tk 34250-65
7.0 mm Ø	tk 34250-70
7.5 mm Ø	tk 34250-75
8.0 mm Ø	tk 34250-80
8.5 mm Ø	tk 34250-85
9.0 mm Ø	tk 34250-90
9.5 mm Ø	tk 34250-95

10.0 mm Ø	tk 34251-00
10.5 mm Ø	tk 34251-05
11.0 mm Ø	tk 34251-10
11.5 mm Ø	tk 34251-15
12.0 mm Ø	tk 34251-20
12.5 mm Ø	tk 34251-25
13.0 mm Ø	tk 34251-30
13.5 mm Ø	tk 34251-35
14.0 mm Ø	tk 34251-40
14.5 mm Ø	tk 34251-45
15.0 mm Ø	tk 34251-50
15.5 mm Ø	tk 34251-55
16.0 mm Ø	tk 34251-60
16.5 mm Ø	tk 34251-65
17.0 mm Ø	tk 34251-70
17.5 mm Ø	tk 34251-75
18.0 mm Ø	tk 34251-80
18.5 mm Ø	tk 34251-85
19.0 mm Ø	tk 34251-90
19.5 mm Ø	tk 34251-95

20.0 mm Ø	tk 34252-00
21.0 mm Ø	tk 34252-10
22.0 mm Ø	tk 34252-20
23.0 mm Ø	tk 34252-30
24.0 mm Ø	tk 34252-40
25.0 mm Ø	tk 34252-50
26.0 mm Ø	tk 34252-60
27.0 mm Ø	tk 34252-70
28.0 mm Ø	tk 34252-80
29.0 mm Ø	tk 34252-90
30.0 mm Ø	tk 34253-00

HEGAR

4 mm - 17 mm Ø	14	tk 34260-14
1 mm - 26 mm Ø	26	tk 34260-26

Stück per Satz	Satz, ohne Metalletui
<i>Pieces per set</i>	<i>Set, without metal case</i>
Pièces per jeu	Jeu, sans boîte en métal
<i>Piezas para juego</i>	<i>Juego, sin caja de metal</i>
Pezzi per serie	Serie, senza astuccio metallico

Uterus-Dilatatoren
Uterine dilators

Dilatateurs du col de l'utérus
Dilatadores uterinos
Dilatatori uterini



HEGAR

4 mm - 17 mm Ø	14	tk 34261-14	tk 34261-15
1 mm - 26 mm Ø	26	tk 34261-26	tk 34261-27

Stück per Satz
Pieces per set

Satz, in Metalletui
Set, in metal case

Metalletui mit 2 Einlegeböden
metal case with 2 shelves

Pièces per jeu
Piezas para juego

Jeu, en boîte de métal
Juego, en caja de metal

boîte de métal avec 2 éagères
caja de metal con 2 estantes

Pezzi per serie

Serie, con astuccio metallico

astuccio metallica con 2 scaffali

Uterus-Dilatatoren
Uterine dilators

Dilatateurs du col de l'utérus
Dilatadores uterinos
Dilatatori uterini



HEGAR	
1 / 2 mm Ø	tk 34262-02
3 / 4 mm Ø	tk 34262-04
5 / 6 mm Ø	tk 34262-06
7 / 8 mm Ø	tk 34262-08
9 / 10 mm Ø	tk 34262-10
11 / 12 mm Ø	tk 34262-12
13 / 14 mm Ø	tk 34262-14
15 / 16 mm Ø	tk 34262-16
17 / 18 mm Ø	tk 34262-18
19 / 20 mm Ø	tk 34262-20
21 / 22 mm Ø	tk 34262-22
23 / 24 mm Ø	tk 34262-24
25 / 26 mm Ø	tk 34262-26

HEGAR		
3 / 4 mm - 17 / 18 mm Ø	8	tk 34265-05
1 / 2 mm - 25 / 26 mm Ø	13	tk 34265-06

Stück per Satz Satz, allein
Pieces per set *Set, only*
Pièces per jeu Jeu, seul
Piezas para juego *Juego, solo*
Pezzi per serie Serie, solo



1:3



1:3

HEGAR

3 / 4 mm - 17 / 18 mm Ø	8	tk 34265-00	tk 34265-08
1 / 2 mm - 25 / 26 mm Ø	13		tk 34265-13

Stück per Satz Satz in Stoffrolltasche
Pieces per set *Set in canvas roll*
Pièces per jeu Jeu en poche de textile
Piezas para juego *Juego en bolsa de tela*
Pezzi per serie Serie in astuccio di tela

Satz, in Metalletui
Set, in metal case
Jeu, en boîte de métal
Juego, en caja de metal
Serie, in astuccio metallico

Uterus-Dilatatoren und -Depressoren
Uterine dilators and depressors

Dilatateurs du col de l'utérus et dépresseurs utérins
Dilatadores uterinos y depresores uterinos
 Dilatatori uterini e depressori uterini



HANK		
Fig. 09/10	4.5 / 5.0 mm Ø	tk 34280-10
Fig. 11/12	5.5 / 6.0 mm Ø	tk 34280-12
Fig. 13/14	6.5 / 7.0 mm Ø	tk 34280-14
Fig. 15/16	7.5 / 8.0 mm Ø	tk 34280-16
Fig. 17/18	8.5 / 9.0 mm Ø	tk 34280-18
Fig. 19/20	9.5 / 10.0 mm Ø	tk 34280-20

HANK		
4.5 / 5 mm - 9.5 / 10 mm Ø	6	tk 34281-80

Stück per Satz Satz, allein
Pieces per set Set, only
 Pièces per jeu Jeu, seul
Piezas para juego Juego, solo
 Pezzi per serie Serie, solo



1:3

HANK		
4.5 / 5 mm - 9.5 / 10 mm Ø	6	tk 34281-82

Stück per Satz Satz, in Stoffrolle
Pieces per set Set, in canvas roll
 Pièces per jeu Jeu, en poche de textile
Piezas para juego Juego, en bolsa de tela
 Pezzi per serie Serie, in astuccio di tela



BRAUN
280 mm - 11 "
tk 34295-26

1:3

Hakenzangen
Tenaculum forceps

Pinces pour l'abaissement du col de l'utérus
Pinzas para coger el cuello del útero
Pinze per abbassare il collo dell'utero



**STAUDE-
MOORE**

170 mm - 6¾"

tk 34302-17



BARRETT

180 mm - 7"

tk 34305-18



SKENE

240 mm - 9½"

tk 34301-24



BRAUN

250 mm - 9¾"

tk 34303-25

Hakenzangen
Tenaculum forceps

Pinces pour l'abaissement du col de l'utérus
Pinzas para coger el cuello del útero
 Pinze per abbassare il collo dell'utero



POZZI

255 mm - 10"

tk 34311-26



SCHROEDER

250 mm - 9¾"

tk 34310-25

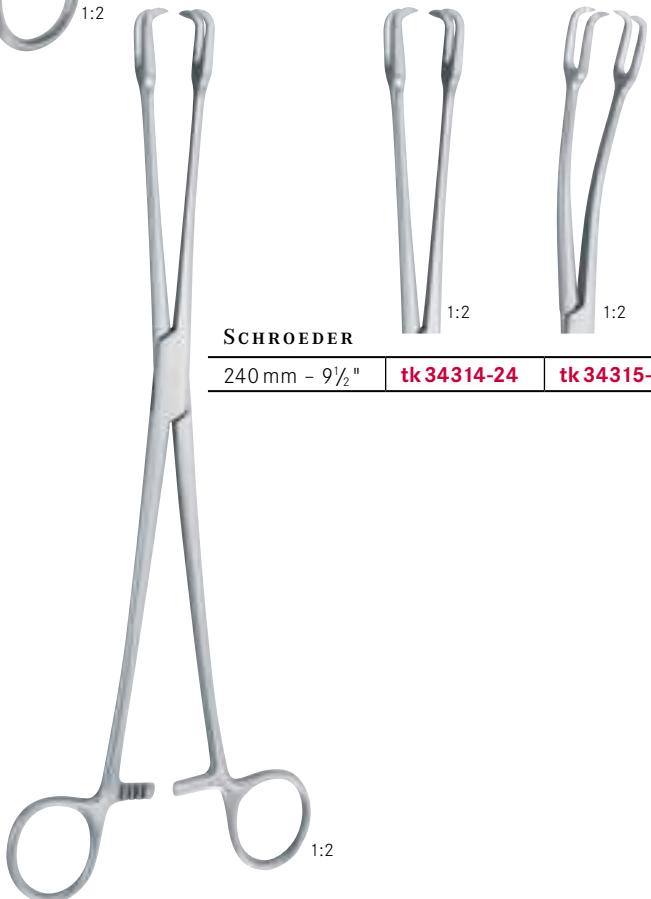

SCHROEDER

240 mm - 9½"

tk 34314-24

tk 34315-24

Hakenzangen
Tenaculum forceps

Pinces pour l'abaissement du col de l'utérus
Pinzas para coger el cuello del útero
Pinze per abbassare il collo dell'utero



1:2

DUPLAY

280 mm - 11 "

tk 34320-28



1:2

IOWA

260 mm - 10 1/4 "

tk 34329-26



1:2

BEACHAM

260 mm - 10 1/4 "

tk 34322-26

Amniotom
Amniotome
Amniotomo
Amniotomo
Amniotomo

Hakenzangen
Tenaculum forceps

Pinces pour l'abaissement du col de l'utérus
Pinzas para coger el cuello del útero
Pinze per abbassare il collo dell'utero



MUSEUX

	240 mm - 9 1/2"	240 mm - 9 1/2"
8 mm	tk 34352-24	tk 34357-24
6 mm	tk 34353-24	tk 34358-24
10 mm	tk 34351-24	tk 34356-24



TEALE

230 mm - 9"
tk 34328-23

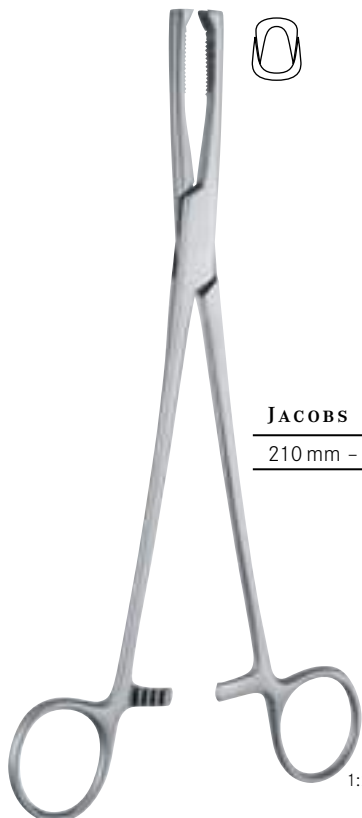

JACOBS

210 mm - 8 1/4"	tk 34360-21	tk 34361-21
-----------------	-------------	-------------

Hakenzangen
Tenaculum forceps

Pinces pour abaissement du col de l'utérus
Pinzas para coger el cuello del útero
Pinze per abbassare il collo dell'utero



PRATT

260 mm - 10 $\frac{1}{4}$ " **tk 34364-26**



CZERNY

205 mm - 8" **tk 34366-21**

Uterus-Polypenzangen
Uterine polypus forceps

Pinces à polypes utérins
Pinzas para pólipos uterinos
 Pinze per polipi uterini

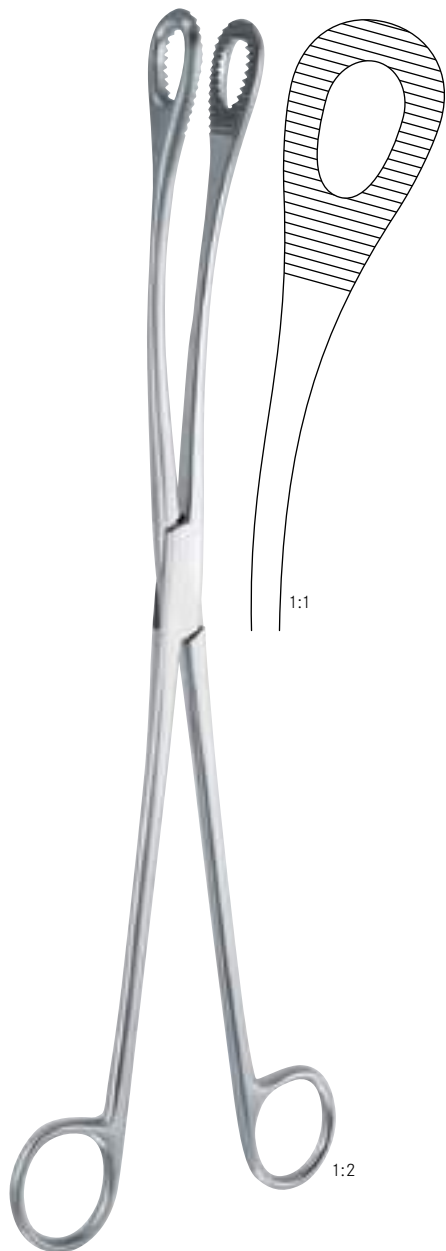

KELLY

320 mm - 12½" **tk 34380-32**



NOTO

270 mm - 10¾" **tk 34375-27**



DOYEN

200 mm - 8" **tk 34370-20**

Uterusfazzangen
Uterine seizing forceps

Pinces hystérolabes
Histerólabos
Pinze isterolabi



DARTIGUES

270 mm - 10 $\frac{3}{4}$ " **tk 34394-27**



SOMER

230 mm - 9" **tk 34393-23**



COLLIN

250 mm - 9 $\frac{3}{4}$ " **tk 34395-25**

Myom-Instrumente
Myoma instruments

Instruments pour myomes
Instrumentos para fibroma
Strumenti per miomi

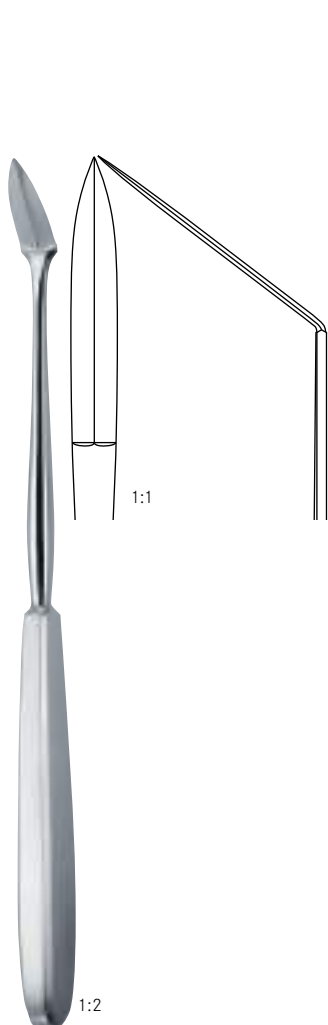

AYRE
230 mm - 9"
tk 34396-23

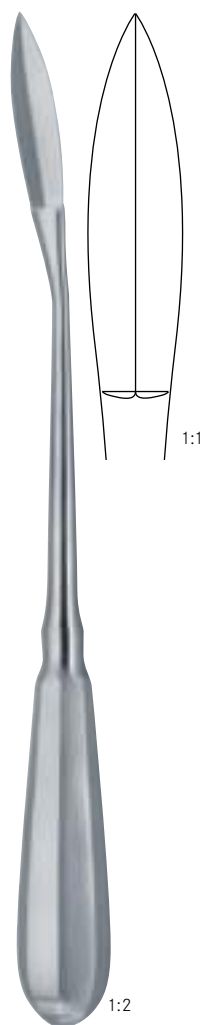

SEGOND
270 mm - 10³/₄"
tk 34397-27



DOYEN
170 mm - 6³/₄"
tk 34399-02

Fistelhaken
Fistula hooks

Crochets pour fistules
Ganchos para fístulas
Uncini per fistole

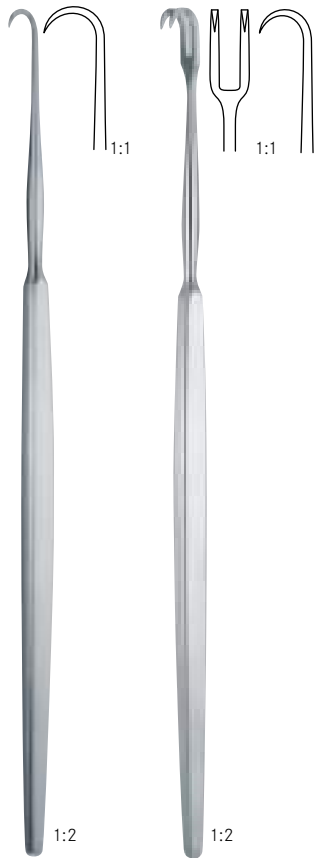

SIMON

	Fig. 1	Fig. 2
220 mm - 8 $\frac{3}{4}$ "	tk 34398-01	tk 34398-02



EMMET		
	Fig. 1	Fig. 2
220 mm - 8 $\frac{3}{4}$ "	tk 16958-01	tk 16958-02
	Fig. 3	Fig. 4
220 mm - 8 $\frac{3}{4}$ "	tk 16958-03	tk 16958-04
	Fig. 5	
220 mm - 8 $\frac{3}{4}$ "	tk 16958-05	

Probeexzisionszangen
Cervical biopsy and specimen forceps

Pinces emporte-pièces à biopsie
Pinzas saca-bocados para biopsia
Pinze taglianti per biopsia



SCHUBERT

210 mm - 8½"	tk 34400-21
280 mm - 11"	tk 34400-29



FAURE

210 mm - 8½"	tk 34410-24
--------------	--------------------



SCHUBERT

260 mm - 10¼"	tk 34440-26
---------------	--------------------

Probeexzisionszangen
Cervical biopsy and specimen forceps

Pinces emporte-pièces à biopsie
Pinzas saca-bocados para biopsia
Pinze taglianti per biopsia



GELHORN

230 mm - 9"

tk 34402-23



THOMS-GAYLOR

220 mm - 8³/₄"

tk 34420-22

240 mm - 9¹/₂"

tk 34420-24

Probeexzisionszangen
Cervical biopsy and specimen forceps

Pinces emporte-pièces à biopsie
Pinzas saca-bocados para biopsia
Pinze taglianti per biopsia

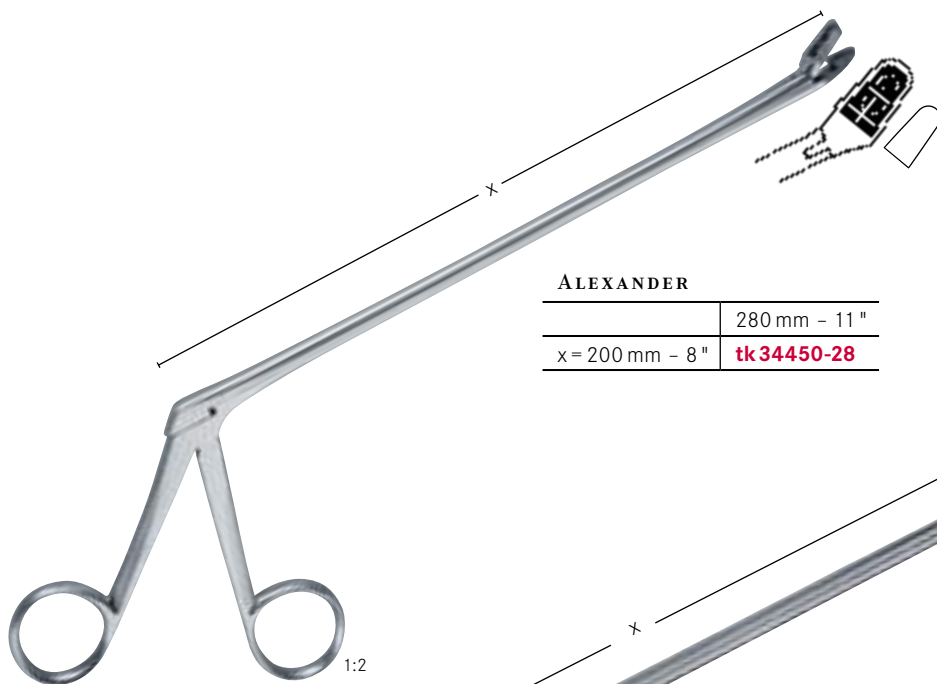

ALEXANDER

	280 mm - 11"
x = 200 mm - 8"	tk 34450-28

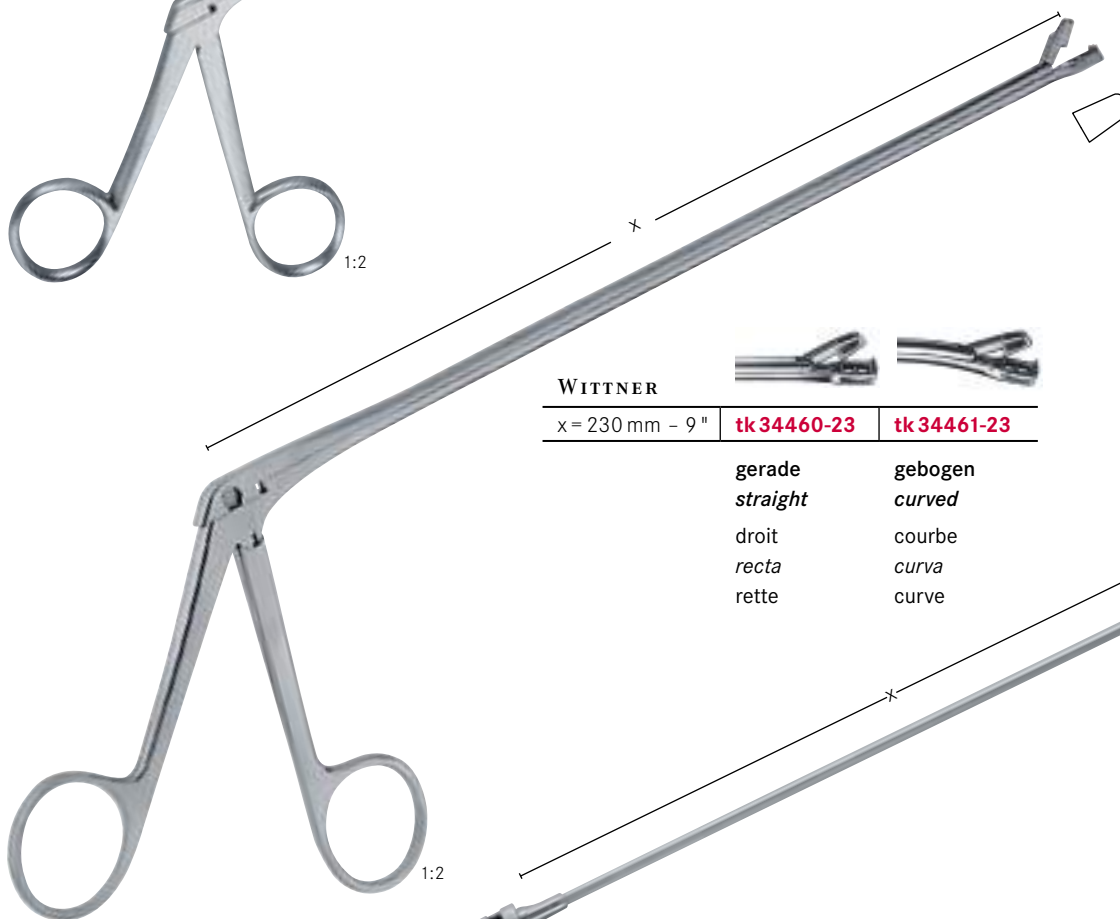

WITTNER

x = 230 mm - 9"	tk 34460-23	tk 34461-23
-----------------	--------------------	--------------------

gerade	gebogen
straight	curved
droit	courbe
recta	curva
rette	curve

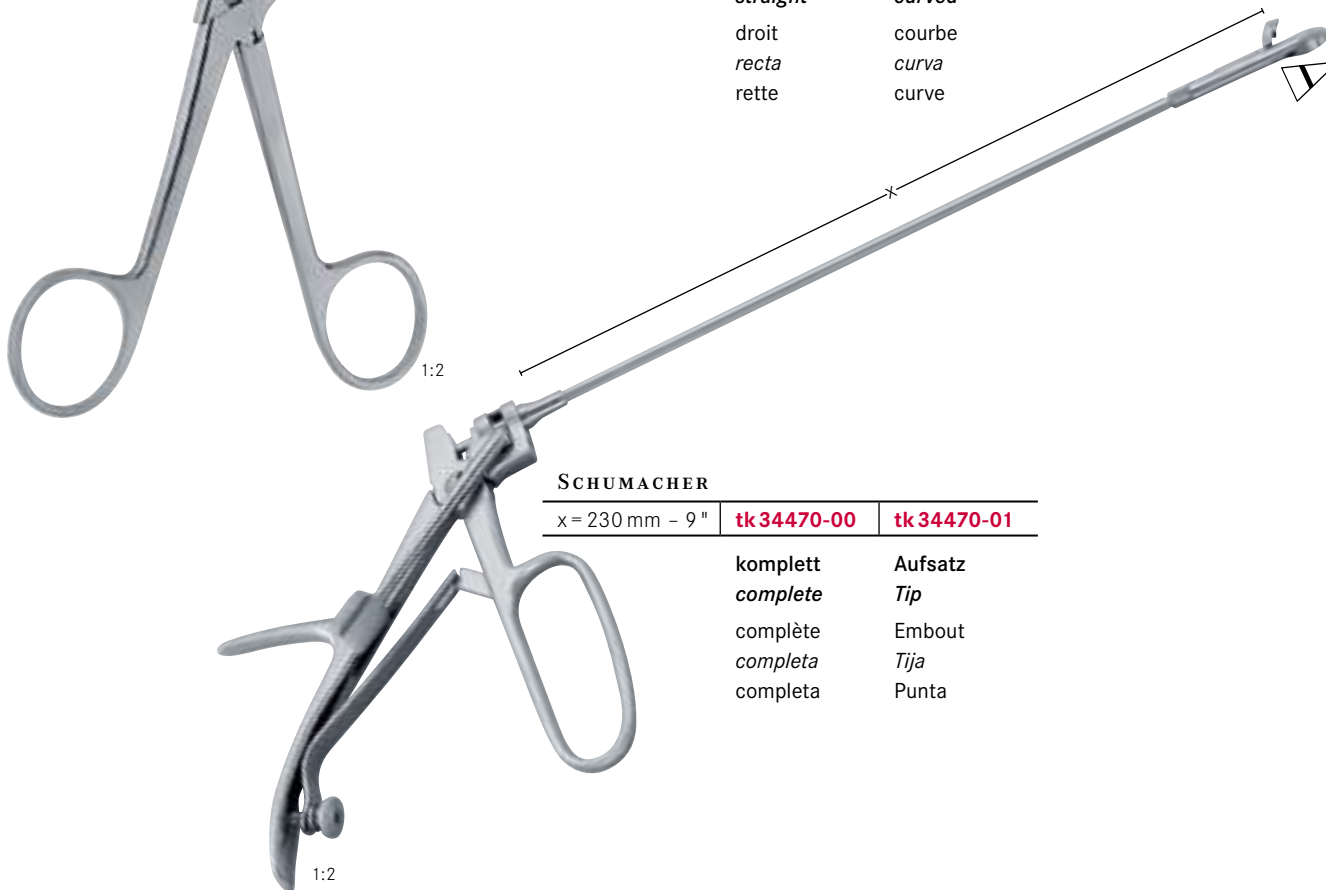

SCHUMACHER

x = 230 mm - 9"	tk 34470-00	tk 34470-01
-----------------	--------------------	--------------------

komplett	Aufsatz
complete	Tip
complète	Embout
completa	Tija
completa	Punta

Probeexzisionszangen
Cervical biopsy and specimen forceps

Pinces emporte-pièces à biopsie
Pinzas saca-bocados para biopsia
Pinze taglianti per biopsia



VAN DOREN

240 mm - 9½"

tk 34470-25

1:2

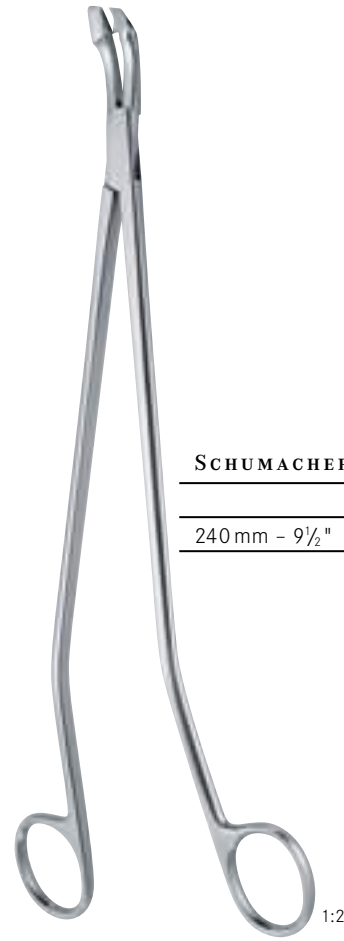

SCHUMACHER

1:1

1:1

Fig. 1

Fig. 2

240 mm - 9½"

tk 34473-01

tk 34473-02

1:2

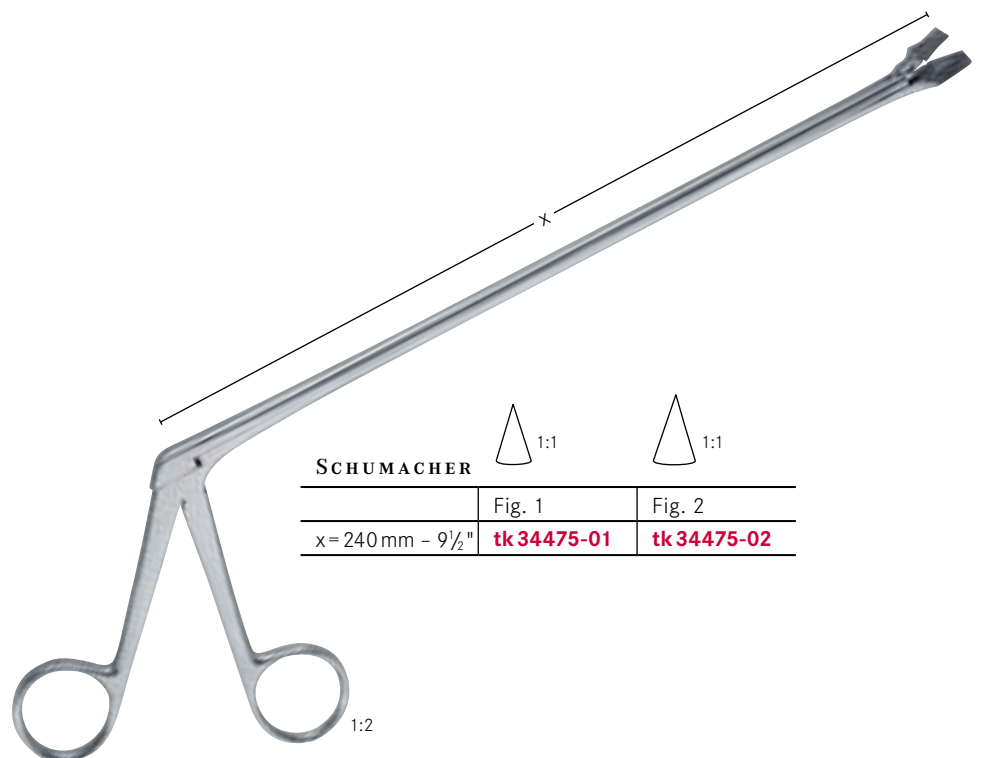

SCHUMACHER

1:1

1:1

Fig. 1

Fig. 2

x = 240 mm - 9½"

tk 34475-01

tk 34475-02

1:2

Probeexzisionszangen
Cervical biopsy and specimen forceps

Pinces emporte-pièces à biopsie
Pinzas saca-bocados para biopsia
Pinze taglianti per biopsia

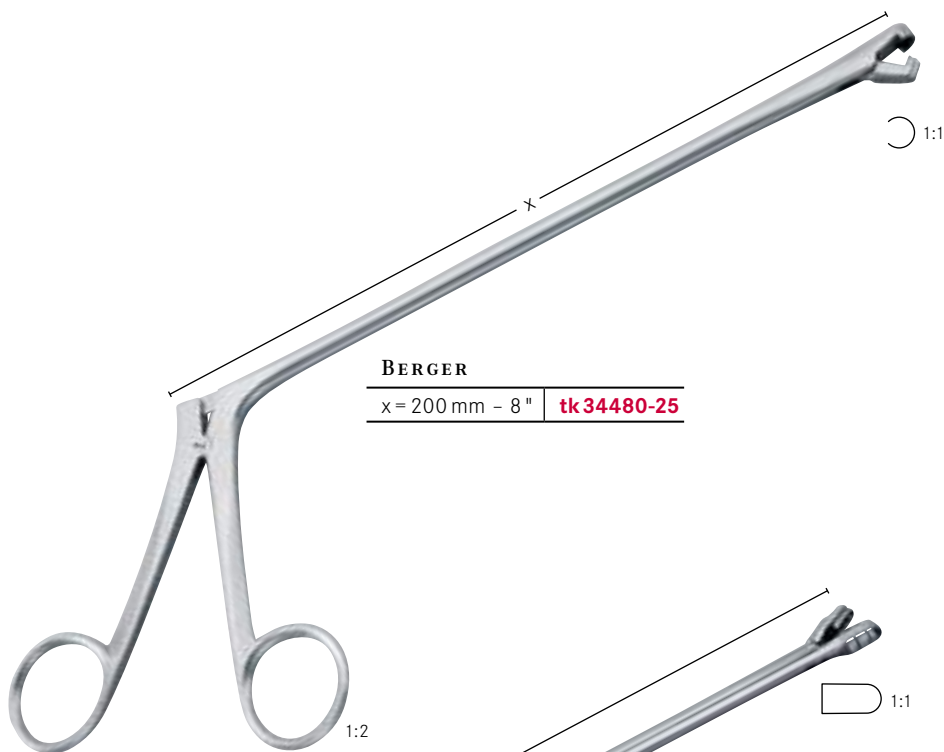

BERGER

x = 200 mm - 8" **tk 34480-25**



EPPENDORFER

x = 200 mm - 8" **tk 34487-20**



KEVORKIAN

x = 245 mm - 9¾" **tk 34489-24**

Probeexzisionszangen
Cervical biopsy and specimen forceps

Pinces emporte-pièces à biopsie
Pinzas saca-bocados para biopsia
Pinze taglianti per biopsia

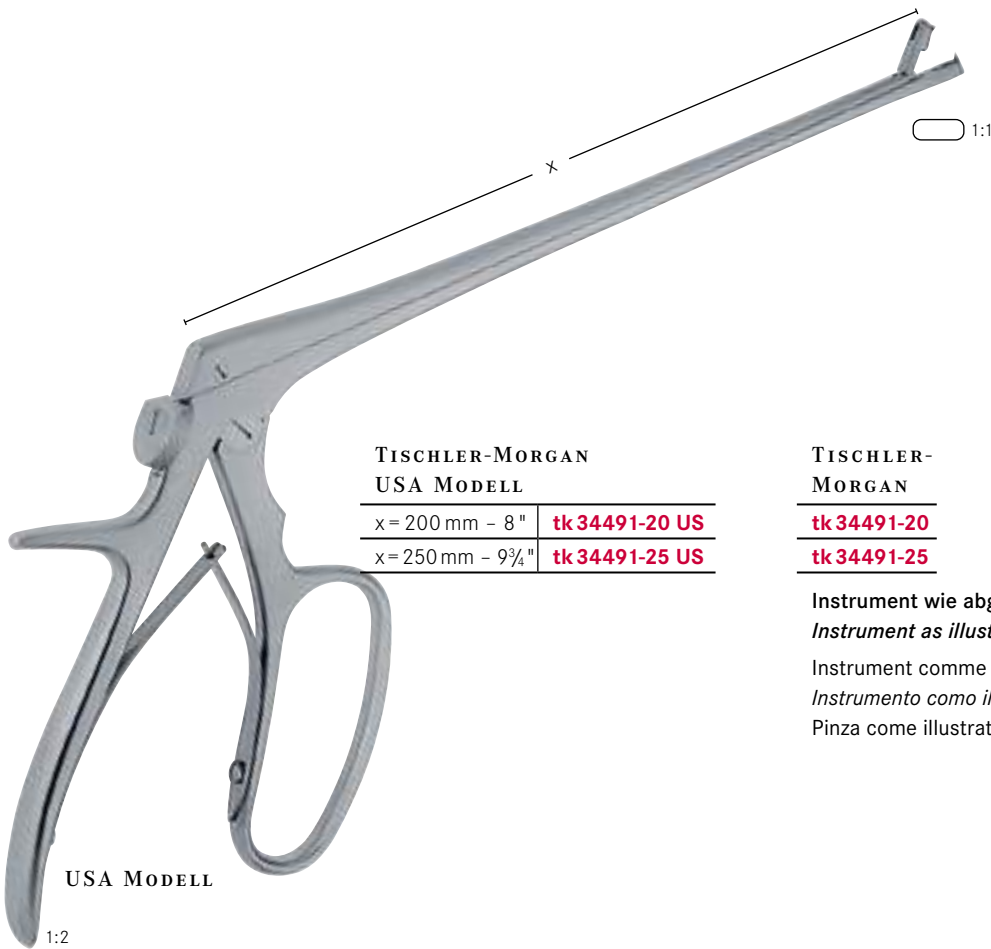

TISCHLER-MORGAN
USA MODELL

x = 200 mm - 8" tk 34491-20 US

x = 250 mm - 9¾" tk 34491-25 US

TISCHLER-
MORGAN

tk 34491-20

tk 34491-25

Instrument wie abgebildet, jedoch ohne Feststellschraube.
Instrument as illustrated, but without locking screw.

Instrument comme illustré, mais sans vis de fixation.

Instrumento como ilustrado, pero sin tornillo de fijación.

Pinza come illustrata però senza vite di fissaggio.

Probeexzisionszangen
Cervical biopsy and specimen forceps

Pinces emporte-pièces à biopsie
Pinzas saca-bocados para biopsia
Pinze taglianti per biopsia



**MINI-TISCHLER
USA MODELL**

x = 200 mm - 8"	tk 34492-20 US
x = 250 mm - 9¾"	tk 34492-25 US

**MINI-
TISCHLER**

tk 34492-20
tk 34492-25

Instrument wie abgebildet, jedoch ohne Feststellschraube.
Instrument as illustrated, but without locking screw.

Instrument comme illustré, mais sans vis de fixation.
Instrumento como ilustrado, pero sin tornillo de fijación.
Pinza come illustrata però senza vite di fissaggio.

Probeexzisionszangen
Cervical biopsy and specimen forceps

Pinces emporte-pièces à biopsie
Pinzas saca-bocados para biopsia
Pinze taglianti per biopsia



UNI-TISCHLER

3 x 7 mm	tk 34492-01
----------	-------------

gerade, Aufsatz allein
straight, Tip only
droit, mors seul
recta, boca sola
retta, punta sola



tk 34490-00

Uni-Griff allein
Handle only
Poignee seule
Mango solo
Manico solo



UNI-TISCHLER

3 x 7 mm	tk 34492-02
----------	-------------

aufwärts, Aufsatz allein
up, Tip only
haut, mors seul
arriba, boca sola
in alto, punta sola



UNI-TISCHLER

3 x 7 mm	tk 34492-03
----------	-------------

abwärts, Aufsatz allein
down, Tip only
bas, mors seul
abajo, boca sola
in basso, punta sola



UNI-TOWNSEND

2.3 x 4 mm	tk 34492-04
------------	-------------

gerade, Aufsatz allein
straight, Tip only
droit, mors seul
recta, boca sola
retta, punta sola



UNI-TOWNSEND

2.3 x 4 mm	tk 34492-05
------------	-------------

aufwärts, Aufsatz allein
up, Tip only
haut, mors seul
arriba, boca sola
in alto, punta sola



UNI-TOWNSEND

2.3 x 4 mm	tk 34492-06
------------	-------------

abwärts, Aufsatz allein
down, Tip only
bas, mors seul
abajo, boca sola
in basso, punta sola



UNI-KEVORKIAN

3 x 9 mm	tk 34492-07
----------	-------------

Aufsatz allein
Tip only
Mors seul
Boca sola
Punta sola



UNI-OVAL

3 x 5 mm	tk 34492-08
----------	-------------

Aufsatz allein
Tip only
Mors seul
Boca sola
Punta sola



UNI-BURKE

3 x 5 mm	tk 34492-09
----------	-------------

Aufsatz allein
Tip only
Mors seul
Boca sola
Punta sola



tk 34491-00

Uni-Griff allein mit Ring
Handle only
Poignee seule
Mango solo
Manico solo

Biopsieküretten
Biopsy curettes

Curettes pour biopsie
Curetas para biopsía
Curette per biopsia



RANDALL

	4 mm Ø
240 mm - 9½"	tk 34800-24



KEVORKIAN

300 mm - 12"	tk 34810-30	tk 34813-30
--------------	--------------------	--------------------

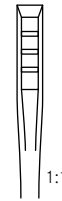

fest, ohne Korb
rigid, without basket
rigide, sans panier
rigida, sin cesta
rigida, senza cestino

fest, mit Korb
rigid, with basket
rigide, avec panier
rigida, con cesta
rigida, con cestino

tk 34811-30

tk 34812-30

biegsam, ohne Korb
malleable, without basket
malléable, sans panier
malleable, sin cesta
flessibile, senza cestino

biegsam, mit Korb
malleable, with basket
malléable, avec panier
malleable, con cesta
flessibile, con cestino

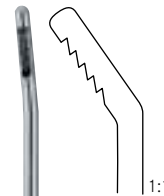

NOVAK

	4 mm Ø
230 mm - 9"	tk 34805-23

MINI-NOVAK

	235 mm - 9¼"
1 mm Ø	tk 34807-23
2 mm Ø	tk 34808-23
3 mm Ø	tk 34809-23

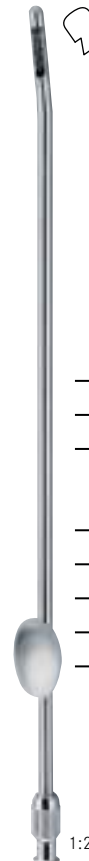

Absaugküretten
Aspirating curettes

Curettes d'aspiration
Curetas de aspiración
Curette per aspirazione

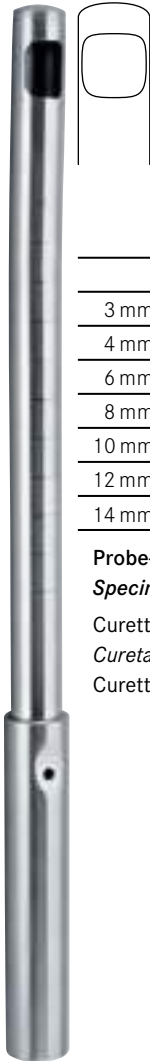

	200 mm - 11½"
3 mm Ø	tk 35530-03
4 mm Ø	tk 35530-04
6 mm Ø	tk 35530-06
8 mm Ø	tk 35530-08
10 mm Ø	tk 35530-10
12 mm Ø	tk 35530-12
14 mm Ø	tk 35530-14

Probe- und Absaugkürette

Specimen and aspirating curette

Curette à biopsies et d'aspiration

Cureta de biopsia y de aspiración

Curette per biopsia ed per aspirazione



120 mm - 4¾"	tk 35530-50
--------------	--------------------

Kupplungsstück

Coupling piece

Pièce d'accouplement

Pieza de conexión

Pezzo di connessione

1:2

Salpingograph
Salpingograph

Salpingographe
Salpingógrafo
Salpingografo



SCHULTZE

295 mm - 11½" **tk 34880-00**

Salpingograph, komplett im Holzetui
Salpingograph, complete in wooden case
Salpingographe, complet en etui de bois
Salpingógrafo, completa en caja de madera
Salpingografo, completo in astuccio di legno

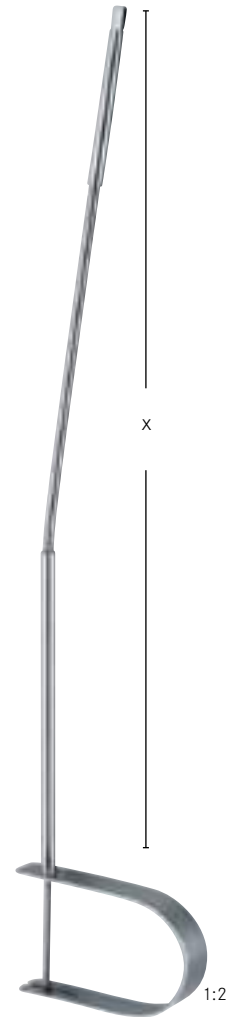

	4 mm Ø
x = 230 mm - 9"	tk 34872-00

Zange zum Entfernen von Spiralen
Forceps for I.U.D. removings

Pince pour enlever des stérilets
Pinza para remover la espiral de esterilidad
Pinza per distaccare la spirale

Uterusküretten | Currettes utérines
Uterine curettes | Curetas uterinas
 Curette uterine

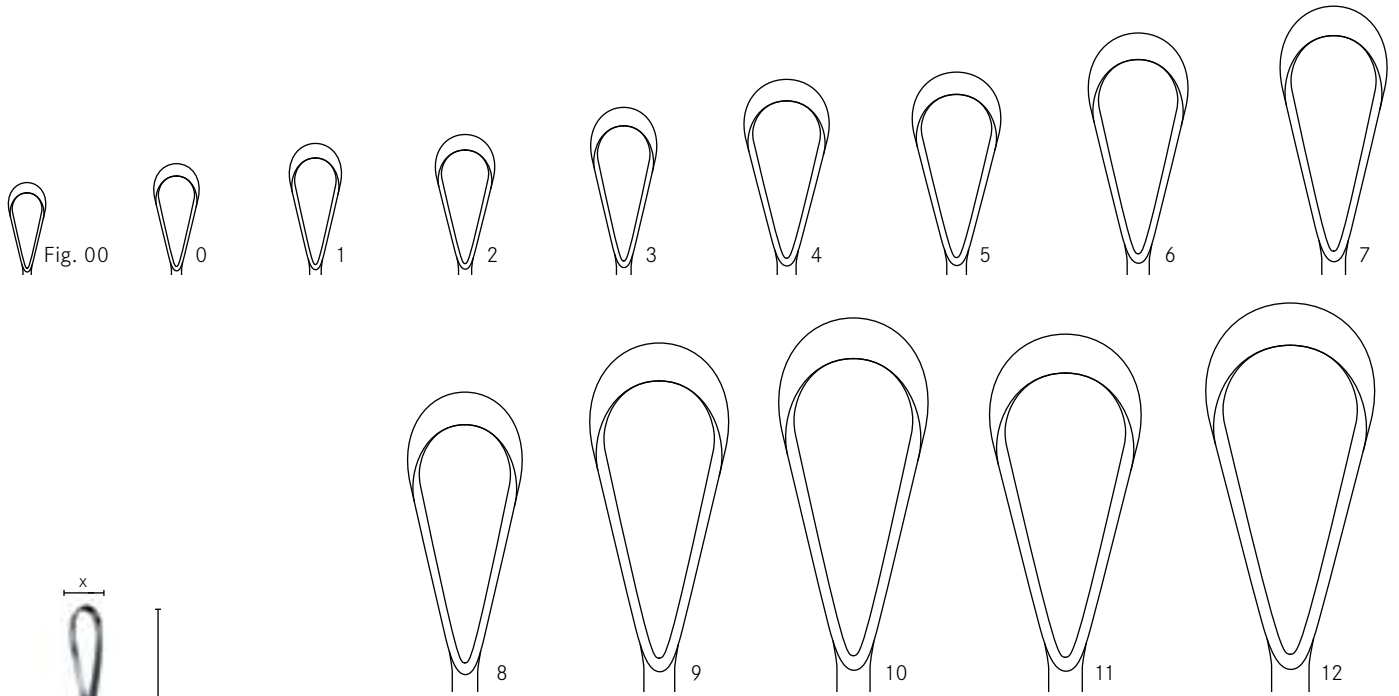

scharf, biegsam <i>sharp, malleable</i>	stumpf, biegsam <i>blunt, malleable</i>	scharf, fest <i>sharp, rigid</i>	stumpf, fest <i>blunt, rigid</i>
tranchante, malléable <i>cortante, maleable</i>	mousse, malléable <i>roma, maleable</i>	tranchante, rigide <i>cortante, rigida</i>	mousse, rigida <i>roma, rigida</i>
tagliente, flessibile	smussa, flessibile	tagliente, rigida	smussa, rigida

RECAMIER

y=260mm-10¼"	Fig.	x=mm				
	00	5	tk 35000-20	tk 35001-20	tk 35002-20	tk 35003-20
	0	6	tk 35000-00	tk 35001-00	tk 35002-00	tk 35003-00
	1	7	tk 35000-01	tk 35001-01	tk 35002-01	tk 35003-01
	2	8	tk 35000-02	tk 35001-02	tk 35002-02	tk 35003-02
	3	9	tk 35000-03	tk 35001-03	tk 35002-03	tk 35003-03
	4	11	tk 35000-04	tk 35001-04	tk 35002-04	tk 35003-04
	5	12	tk 35000-05	tk 35001-05	tk 35002-05	tk 35003-05
	6	14	tk 35000-06	tk 35001-06	tk 35002-06	tk 35003-06
	7	15	tk 35000-07	tk 35001-07	tk 35002-07	tk 35003-07
	8	16	tk 35000-08	tk 35001-08	tk 35002-08	tk 35003-08
	9	19	tk 35000-09	tk 35001-09	tk 35002-09	tk 35003-09
	10	20	tk 35000-10	tk 35001-10	tk 35002-10	tk 35003-10
	11	21	tk 35000-11	tk 35001-11	tk 35002-11	tk 35003-11
	12	23	tk 35000-12	tk 35001-12	tk 35002-12	tk 35003-12

y=310mm-12¼"	Fig.	mm				
	00	5	tk 35004-20	tk 35005-20	tk 35006-20	tk 35007-20
	0	6	tk 35004-00	tk 35005-00	tk 35006-00	tk 35007-00
	1	7	tk 35004-01	tk 35005-01	tk 35006-01	tk 35007-01
	2	8	tk 35004-02	tk 35005-02	tk 35006-02	tk 35007-02
	3	9	tk 35004-03	tk 35005-03	tk 35006-03	tk 35007-03
	4	11	tk 35004-04	tk 35005-04	tk 35006-04	tk 35007-04
	5	12	tk 35004-05	tk 35005-05	tk 35006-05	tk 35007-05
	6	14	tk 35004-06	tk 35005-06	tk 35006-06	tk 35007-06
	7	15	tk 35004-07	tk 35005-07	tk 35006-07	tk 35007-07
	8	16	tk 35004-08	tk 35005-08	tk 35006-08	tk 35007-08
	9	19	tk 35004-09	tk 35005-09	tk 35006-09	tk 35007-09
	10	20	tk 35004-10	tk 35005-10	tk 35006-10	tk 35007-10
	11	21	tk 35004-11	tk 35005-11	tk 35006-11	tk 35007-11
	12	23	tk 35004-12	tk 35005-12	tk 35006-12	tk 35007-12



Uterusküretten | Currettes utérines
 Uterine curettes | Curetas uterinas
 Curette uterine

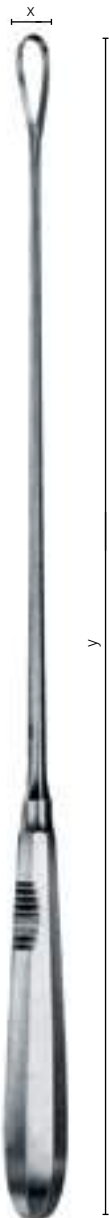
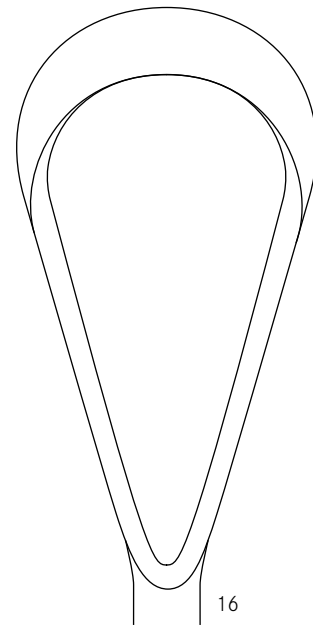
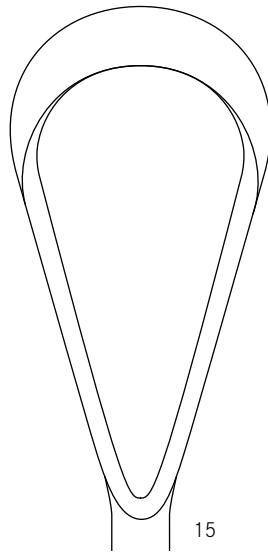
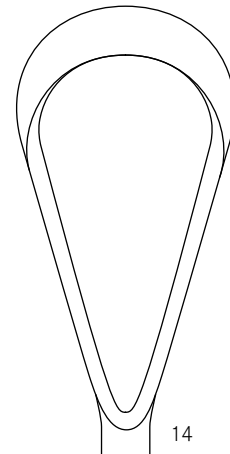
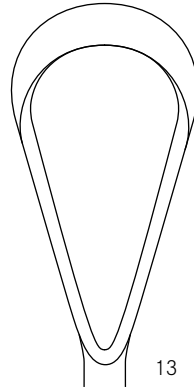

scharf, biegsam
sharp, malleable
 tranchante, malléable
cortante, maleable
 tagliente, flessibile

stumpf, biegsam
blunt, malleable
 mousse, malléable
roma, maleable
 smussa, flessibile

scharf, fest
sharp, rigid
 tranchante, rigide
cortante, rigida
 tagliente, rigida

stumpf, fest
blunt, rigid
 mousse, rigid
roma, rigida
 smussa, rigida

RECAMIER

y=340mm-13½"	Fig.	x=mm				
	13	25	tk 35004-13	tk 35005-13	tk 35006-13	tk 35007-13
	14	30	tk 35004-14	tk 35005-14	tk 35006-14	tk 35007-14
	15	35	tk 35004-15	tk 35005-15	tk 35006-15	tk 35007-15
	16	40	tk 35004-16	tk 35005-16	tk 35006-16	tk 35007-16

Uterusküretten | Currettes utérines
Uterine curettes | *Curetas uterinas*
Curette uterine

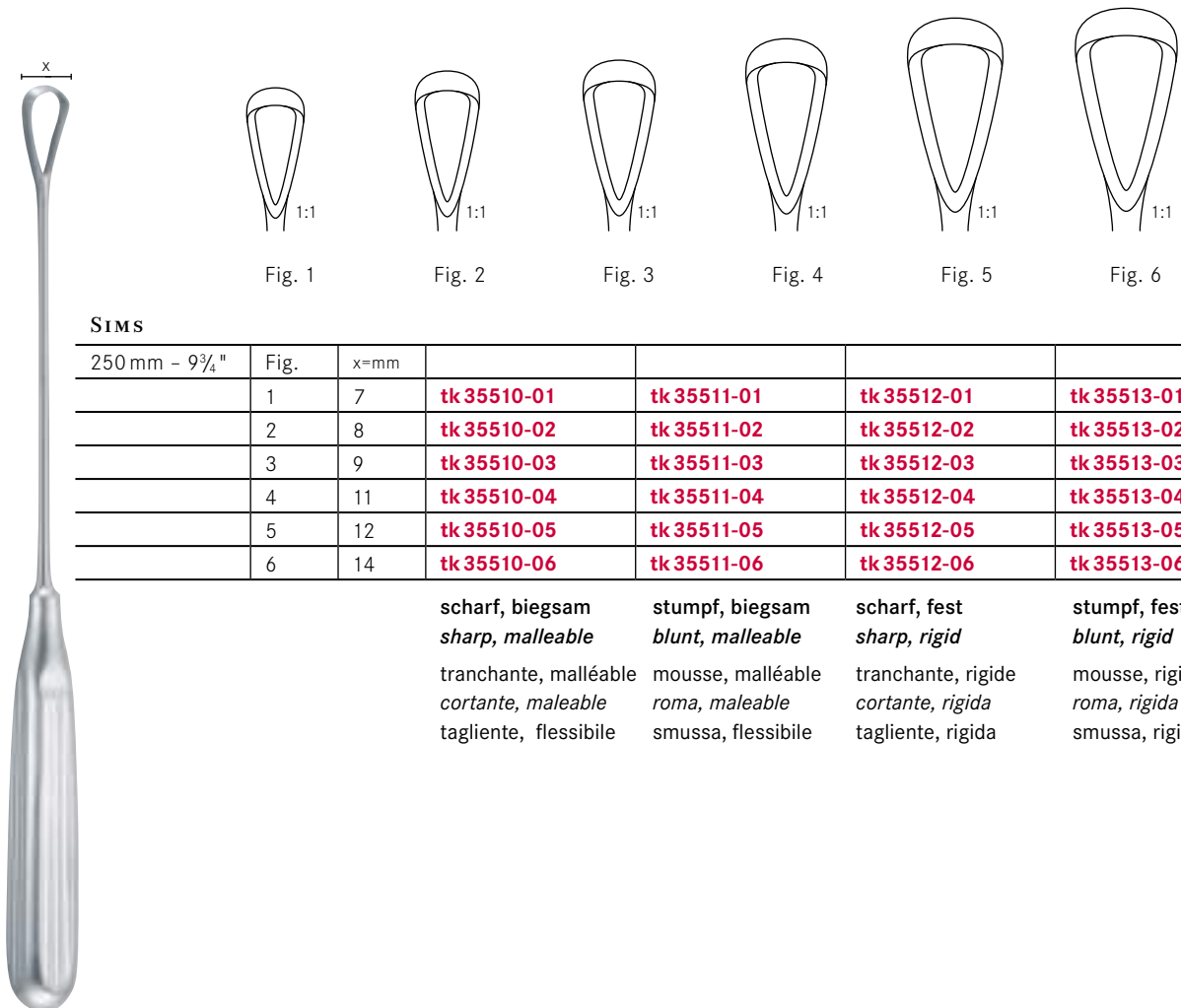

SIMS

250 mm - 9 3/4"	Fig.	x=mm				
	1	7	tk 35510-01	tk 35511-01	tk 35512-01	tk 35513-01
	2	8	tk 35510-02	tk 35511-02	tk 35512-02	tk 35513-02
	3	9	tk 35510-03	tk 35511-03	tk 35512-03	tk 35513-03
	4	11	tk 35510-04	tk 35511-04	tk 35512-04	tk 35513-04
	5	12	tk 35510-05	tk 35511-05	tk 35512-05	tk 35513-05
	6	14	tk 35510-06	tk 35511-06	tk 35512-06	tk 35513-06

scharf, biegsam
sharp, malleable

tranchante, malléable
cortante, maleable
tagliente, flessibile

stumpf, biegsam
blunt, malleable

mousse, malléable
roma, maleable
smussa, flessibile

scharf, fest
sharp, rigid

tranchante, rigide
cortante, rigida
tagliente, rigida

stumpf, fest
blunt, rigid

mousse, rigid
roma, rigida
smussa, rigida

Scharfe Löffel
Uterine spoons

Curettes tranchantes
Cucharillas cortantes
Cucchiai taglianti



SIMON



	Fig. 1	Fig. 2	Fig. 3
250 mm - 9 3/4"	tk 24445-01	tk 24445-02	tk 24445-03

scharf, fest
sharp, rigid

tranchante, rigide
cortante, rigida
taglianti, rigido

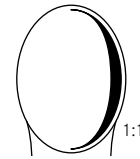
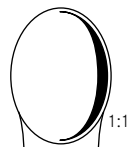
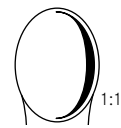

Fig. 4	Fig. 5	Fig. 6
tk 24445-04	tk 24445-05	tk 24445-06



SCHRÖDER

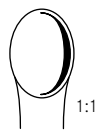
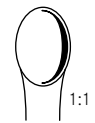

	Fig. 1	Fig. 2	Fig. 3
300 mm - 12"	tk 24448-01	tk 24448-02	tk 24448-03

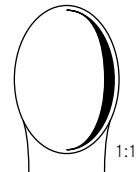
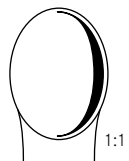
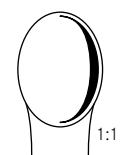

Fig. 4	Fig. 5	Fig. 6
tk 24448-04	tk 24448-05	tk 24448-06

Geburtszangen
Obstetrical forceps

Forceps obstétriques
Forceps obstétricos
Forcipi



SIMPSON

1:3

300 mm - 12"	tk 35600-30
--------------	--------------------



SIMPSON-
BRAUN

330 mm - 13"	tk 35601-33
360 mm - 14 $\frac{1}{4}$ "	tk 35601-36



NAEGELE

360 mm - 14 $\frac{1}{4}$ "	tk 35605-36
400 mm - 16"	tk 35605-40



PIPER

1:3

440 mm - 17 $\frac{1}{4}$ "	tk 35607-44
-----------------------------	--------------------

Geburtszangen
*Obstetrical forceps*Forceps obstétriques
Forceps obstétricos
ForcipiSIMPSON-
LUIKART

1:3

360 mm - 14 $\frac{1}{4}$ " **tk 35612-36**

1:3

WRIGLEY

230 mm - 9" **tk 35613-23**für Kaiserschnitt
for caesarian section
pour césarienne
para operación cesárea
per taglio cesareo

1:3

DELEE

300 mm - 12" **tk 35615-30**

DELEE

360 mm - 14 $\frac{1}{4}$ " **tk 35618-36**390 mm - 15 $\frac{1}{2}$ " **tk 35618-39**

Geburtszangen
Obstetrical forceps

Forceps obstétriques
Forceps obstétricos
Forcipi



ELLIOT

320 mm - 12½"	tk 35620-32
380 mm - 15"	tk 35620-38



MCLEAN

360 mm - 14¼"	tk 35622-36
---------------	--------------------



KIELLAND

410 mm - 16¼"	tk 35635-41
---------------	--------------------



KIELLAND-
LUIKART

400 mm - 16"	tk 35637-40
--------------	--------------------

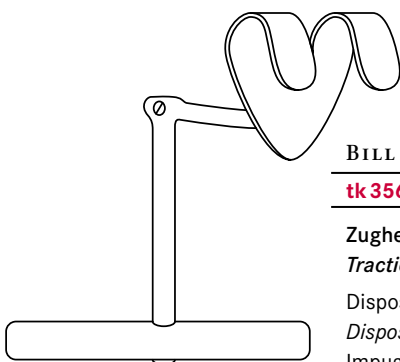

BILL

tk 35640-00

Zughebel, passend für alle Geburtszangen mit gehornem Standard-Griff
Traction handle for all the forceps with horned standard handle

Dispositif de traction pour tous les forceps avec manche normal à cornes
Dispositivo de tracción para todos los forceps con mango standard cornudo

Impugnatura di trazione adatto a tutti i forcipi con manico standard con corne

Geburtshilfe | Obstétrique
 Obstetrics | Obstetricia
 Ostetricia



1:2

SELLHEIM

280 mm - 11" | **tk 35664-28**

Geburtslöffel
 Obstetric lever

Cuillère obstétricale
 Cuchara obstétrica
 Cucchaio obstetrico



1:2

BRAUN

325 mm - 12¾" | **tk 35745-30**

Dekapitationshaken
 Decapitating hook

Crochet de décapitation
 Grancho de descapitación
 Uncino di decapitazione

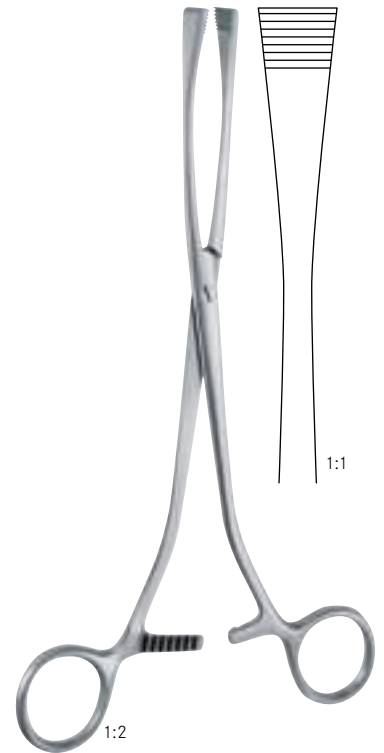

1:2

1:1

**GREEN-
 ARMYTAGE**

210 mm - 8¼" | **tk 35665-21**

Uterusklemmzange
 Uterine elevating forceps

Pince uterine
 Pinza para el útero
 Pinza uterina

Geburtshilfe | Obstétrique
Obstetrics | *Obstetricia*
Ostetricia



SMELLIE

250 mm - 10" **tk 35741-25**

Perforatorium
Perforator

Perforateur
Perforador
Perforatore



BRAUN

420 mm - 16½" **tk 35750-42**

Kranioklast, ein Maul gefenstert
Cranioclast, one jaw fenestrated

Cranioclaste, une partie fenestrée
Craneolasto, una boca fenestrada
Cranioclaste, un lato fenestrato



TARNIER

460 mm - 17¼" **tk 35748-46**

Basiotrib
Basiotribe

Basiotribe
Basiotribo
Basiotribo

Abortuszangen – Abortusküretten
Abortion forceps – Ovum curettes

Pinces à faux germes – Curette d'avortement
Pinzas para aborto – Curetas para aborto
 Pinze per placenta ed aborto – Curette per placenta ed aborto

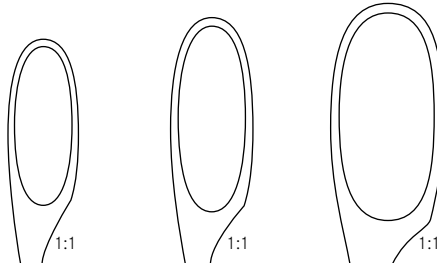

WINTER

	Fig. 1	Fig. 2	Fig. 3
280 mm - 11 "	tk 35701-28	tk 35702-28	tk 35703-28

gerade
straight
 droit
recta
 rette

tk 35711-28	tk 35712-28	tk 35713-28
--------------------	--------------------	--------------------

gebogen
curved
 courbe
curva
 curve

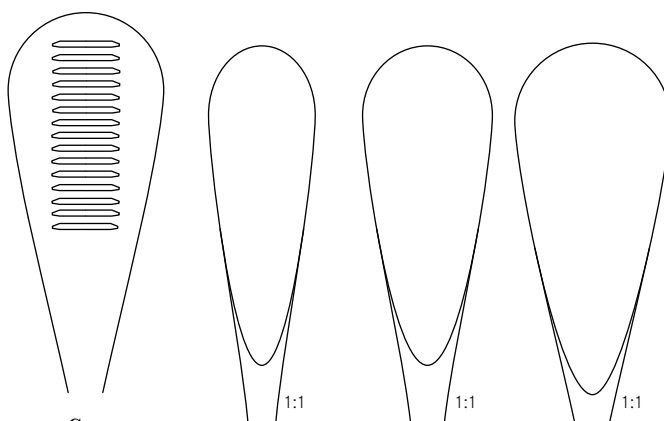

CUZZI

	14.5 mm	18.0 mm	21.0 mm
300 mm - 12 "	tk 35730-01	tk 35730-02	tk 35730-03

stumpf, Rückseite gerieft
blunt, back serrated
 mousse, dos strié
romo, dorso estriado
 smusso, dorso zigrinato

Abortuszangen – Abortusküretten
Abortion forceps – Ovum curettes

Pinces à faux germes – Curette d'avortement
Pinzas para aborto – Curetas para aborto

Pinze per placenta ed aborto – Curette per placenta ed aborto

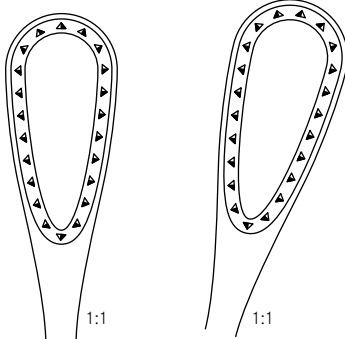

SAENGER

270 mm - 10³/₄"

tk 35720-27

tk 35721-27

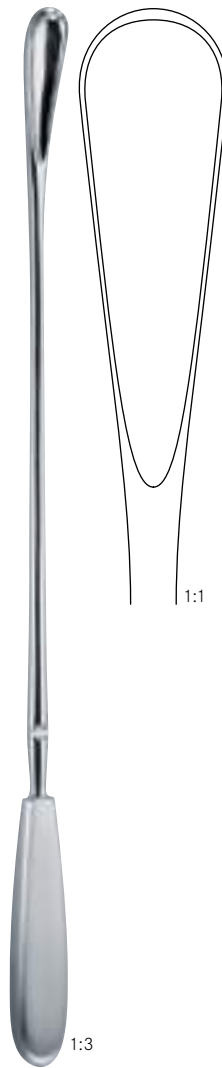

1:1

1:3

WALLICH

420 mm - 16¹/₂"

tk 35735-02

stumpf
blunt

mousse
roma
smussa



1:1

1:3

PESTALOZZA

300 mm - 12"

tk 35732-30

Nabelschnurklemmen
Umbilical cord clamps

Clamps pour le cordon ombilical
Clamps umbilicales
Pinze ombelicali

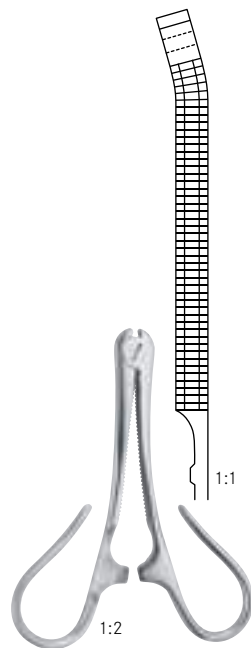

KANE

1:2

1:1

85 mm - 3/4"

tk 35760-08



COLLIN

1:2

90 mm - 3/2"

tk 35761-09

Beckenzirkel
Pelvimeters

Pelvimètres
Pelvimetros
Pelvimetri



MARTIN

340 mm - 13½" **tk 35800-34**

cm / Zoll-Scala
cm / inch-scale

échelle en cm / pouces
escala cm / pulgadas
scala cm / pollici



COLLIN

350 mm - 13¾" **tk 35805-35**

cm-Scala
cm-scale

échelle en cm
escala en cm
scala in cm



HNO	ORL
ENT	ORL
	ORL





ENT

HNO Hauptkatalog | Catalogue Général ORL
ENT Main Catalog | Catálogo General ORL
Catalogo Generale ORL



Bitte fordern Sie unseren Spezialkatalog an.
Please ask for our special catalogue.

Veillez demander pour notre catalogue spécial.
Por favor preguntan para el catalogo especial.
Per favore domandate per il nostro catalogo speciale.

Ohrspekula | Spéculums auriculaires
Ear specula | *Espéculos auriculares*
Specoli auricolari



1:1

TOYNBEE	○ 1:1	○ 1:1	○ 1:1	○ 1:1
	Fig. 1	Fig. 2	Fig. 3	Fig. 4
	4.5 mm Ø	5.5 mm Ø	6.5 mm Ø	7.5 mm Ø
36 mm - 1½"	tk 50010-11	tk 50010-12	tk 50010-13	tk 50010-14
tk 50010-03		x	x	x
tk 50010-04	x	x	x	x

Satz, für Erwachsene

Set, for adults

Jeu, pour adultes

Juego, para adultos

Serie, per adulti







1:1

RICHNAU HOLMGREN	○ 1:1	○ 1:1	○ 1:1	○ 1:1
	Fig. 0	Fig. 1	Fig. 2	Fig. 3
	3 mm Ø	4 mm Ø	5 mm Ø	6 mm Ø
	tk 50030-00	tk 50030-01	tk 50030-02	tk 50030-03





Ohrspekula | Spéculums auriculaires
 Ear specula | Espéculos auriculares
 Specoli auricolari



GRUBER	 1:1	 1:1	 1:1	 1:1
	Fig. 1	Fig. 2	Fig. 3	Fig. 4
	a = 4.5 mm	a = 5.5 mm	a = 6.5 mm	a = 7.5 mm
	tk 50012-11	tk 50012-12	tk 50012-13	tk 50012-14
tk 50012-03		x	x	x







Satz für Erwachsene
 Set for adults
 Jeu pour adultes
 Juego para adultos
 Serie per adulti



GRUBER	 1:1	 1:1	 1:1	 1:1
	Fig. 1	Fig. 2	Fig. 3	Fig. 4
	4.5 mm Ø	5.5 mm Ø	6.5 mm Ø	7.5 mm Ø
	tk 50013-11	tk 50013-12	tk 50013-13	tk 50013-14
tk 50013-03	x	x	x	x





Satz für Erwachsene
 Set for adults
 Jeu pour adultes
 Juego para adultos
 Serie per adulti



ZÖLLNER	 1:1	 1:1	 1:1	 1:1	 1:1	 1:1
	Fig. 1	Fig. 2	Fig. 3	Fig. 4	Fig. 5	Fig. 6
	5.5 x 6.5 mm	6.5 x 7.5 mm	7.5 x 8.5 mm	8.5 x 9.5 mm	9.5 x 10.5 mm	10.5 x 11.5 mm
	tk 50015-01	tk 50015-02	tk 50015-03	tk 50015-04	tk 50015-05	tk 50015-06
tk 50015-00	x	x	x	x	x	x

Satz für Erwachsene, schwarz
 Set for adults, black
 Jeu pour adultes, noir
 Juego para adultos, negro
 Serie per adulti, nero



POLITZER	 1:1	 1:1	 1:1	 1:1
	Fig. 1	Fig. 2	Fig. 3	Fig. 4
	2 mm Ø	3 mm Ø	4 mm Ø	5 mm Ø
	tk 50018-11	tk 50018-12	tk 50018-13	tk 50018-14
tk 50018-03	x	x	x	
tk 50018-04	x	x	x	x

Satz für Erwachsene
 Set for adults
 Jeu pour adultes
 Juego para adultos
 Serie per adulti

Ohrspekula | Spéculums auriculaires
 Ear specula | Espéculos auriculares
 Specoli auricolari



BOUCHERON

	Fig. 1	Fig. 2	Fig. 3	Fig. 4
	4.5 mm Ø	5.5 mm Ø	6.5 mm Ø	7.5 mm Ø
	tk 50019-11	tk 50019-12	tk 50019-13	tk 50019-14
tk 50019-04	x	x	x	x

Satz für Erwachsene
 Set for adults
 Jeu pour adultes
 Juego para adultos
 Serie per adulti



HARTMANN

	Fig. 0	Fig. 1	Fig. 2
	3.0 mm Ø	4.5 mm Ø	5.5 mm Ø
	tk 50020-10	tk 50020-11	tk 50020-12
tk 50020-03	x	x	x

Satz für Kinder
 Set for children
 Jeu pour enfants
 Juego para niños
 Serie per bambini



HARTMANN

	Fig. 1	Fig. 2	Fig. 3	Fig. 4
	4.5 mm Ø	5.5 mm Ø	6.5 mm Ø	7.5 mm Ø
	tk 50022-11	tk 50022-12	tk 50022-13	tk 50022-14
tk 50022-03		x	x	x
tk 50022-04	x	x	x	x

Satz für Erwachsene
 Set for adults
 Jeu pour adultes
 Juego para adultos
 Serie per adulti



HARTMANN

	Fig. 1	Fig. 2	Fig. 3	Fig. 4	Fig. 5
	2.0 mm Ø	3.5 mm Ø	5.0 mm Ø	6.5 mm Ø	7.5 mm Ø
	tk 50023-11	tk 50023-12	tk 50023-13	tk 50023-14	tk 50023-15
tk 50023-04		x	x	x	x

Satz für Erwachsene, schwarz
 Set for adults, black
 Jeu pour adultes, noir
 Juego para adultos, negro
 Serie per adulti, nero

Ohrspekula | Spéculums auriculaires
 Ear specula | Espéculos auriculares
 Specoli auricolari

SIEGLE

	Fig. 1	Fig. 2	Fig. 3	
	6.5 mm Ø	7.0 mm Ø	8.0 mm Ø	
	tk 50025-01	tk 50025-02	tk 50025-03	tk 50026-07
tk 50025-00	x	x	x	x

Satz komplett
 Set complete
 Jeu complet
 Juego completo
 Serie completa

tk 50025-10

Lupenkörper, allein
 Magnifyer, alone
 Loupe, seule
 Lupa, sola
 Lente, solo

BRUENINGS

	Fig. 1	Fig. 2	Fig. 3	Fig. 4	
	6.5 mm Ø	7.5 mm Ø	8.5 mm Ø	9.5 mm Ø	
	tk 50026-01	tk 50026-02	tk 50026-03	tk 50026-04	tk50026-07
tk 50026-00	x	x	x	x	x

Satz komplett
 Set complete
 Jeu complet
 Juego completo
 Serie completa

tk 50026-10

Lupenkörper, allein
 Magnifyer, alone
 Loupe, seule
 Lupa, sola
 Lente, solo

Stimmgabeln
Tuning forks

Diapasons
Diapasones
Diapasoni



1:2

LUCAE

c 128

tk 50035-10

verschiebbar bis h
variable up to h (engl. b)
variable jusqu'à h (franc. si)
variable hasta h (esp. si)
regolabile fino a h

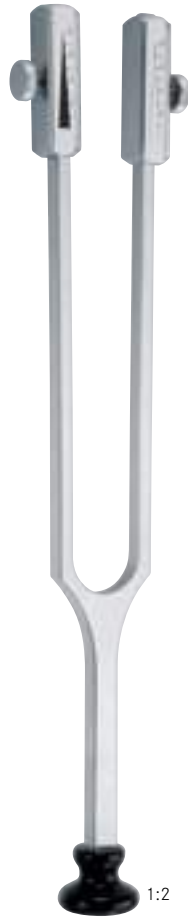

1:2

RYDEL-SEIFFER

C 64 / c 128

tk 50036-11

mit Dämpfer C 64, ohne Dämpfer c 128
with clamps C 64, without clamps c 128
avec curseurs C 64, sans curseurs c 128
con sordinas C 64, sin sordinas c 128
con cursori C 64, senza cursori c 128

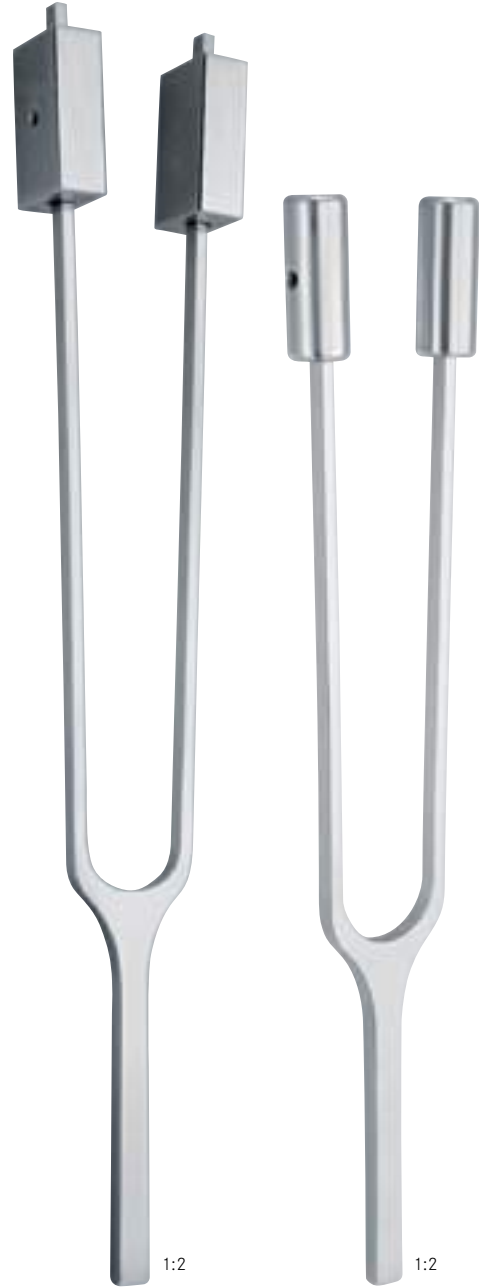

1:2

1:2

FRENCH

C₂16

tk 50040-07

C₁32

tk 50042-08

Stimmgabeln | Diapasons
Tuning forks | Diapasones
Diapasoni



HARTMANN

C 64	c 128	c ¹ 256
tk 50044-09	tk 50045-10	tk 50047-11

a ¹ 440
tk 50078-09

Lärmtrommel | Assourdiseur
Noise drum | Aparato de ruido
Assordatore



BARANY
tk 50300-00

Stimmgabeln | Diapasons
 Tuning forks | Diapasones
 Diapasoni



HARTMANN

c 128	c ¹ 256	c ² 512	c ³ 1024	c ⁴ 2048	C ⁵ 4096
tk 50050-10	tk 50052-11	tk 50053-10	tk 50054-12	tk 50056-13	tk 50058-14



HARTMANN

tk 50050-00

Satz im Etui (tk 50045-10, tk 50047-11, tk 50053-10, tk 50054-12, tk 50056-13)

Set in case (tk 50045-10, tk 50047-11, tk 50053-10, tk 50054-12, tk 50056-13)

Jeu en boîte (tk 50045-10, tk 50047-11, tk 50053-10, tk 50054-12, tk 50056-13)

Juego en estuche (tk 50045-10, tk 50047-11, tk 50053-10, tk 50054-12, tk 50056-13)

Serie in astuccio (tk 50045-10, tk 50047-11, tk 50053-10, tk 50054-12, tk 50056-13)

Stimmgabeln
Tuning forks

Diapasons
Diapasones
Diapasoni

ALUK



c 128	c ¹ 256	c ² 512	c ³ 1024	c ⁴ 2048
tk 50250-01	tk 50250-02	tk 50250-03	tk 50250-04	tk 50250-05

Aluminium
Aluminium
Aluminium
Aluminio
Aluminio



tk 50250-00

Satz im Etui (tk 50250-01 - tk 50250-05)

Set in case (tk 50250-01 - tk 50250-05)

Jeu en boîte (tk 50250-01 - tk 50250-05)

Juego en estuche (tk 50250-01 - tk 50250-05)

Serie in astuccio (tk 50250-01 - tk 50250-05)

Ohrküretten | Curettes auriculaires
 Ear currettes | Curetas auriculares
 Curette auricolari

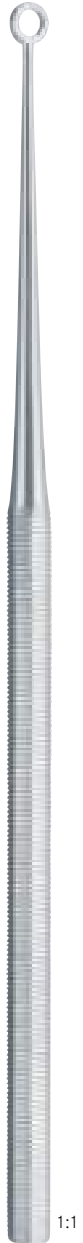

Buck

	Fig. 000	Fig. 00	Fig. 0	Fig. 1	Fig. 2	Fig. 3	Fig. 4	Fig. 5
165mm-6½"	tk 50610-01	tk 50610-02	tk 50610-10	tk 50610-11	tk 50610-12	tk 50610-13	tk 50610-14	tk 50610-15

stumpf
 blunt
 mousse
 roma
 smussa

	Fig. 000	Fig. 00	Fig. 0	Fig. 1	Fig. 2	Fig. 3	Fig. 4	Fig. 5
165mm-6½"	tk 50611-01	tk 50611-02	tk 50611-10	tk 50611-11	tk 50611-12	tk 50611-13	tk 50611-14	tk 50611-15

scharf
 sharp
 tranchante
 cortante
 tagliente



Abbildungen zeigen den Außendurchmesser.
 Pictures show the outer diameter.
 Illustrations représentent le diamètre externe.
 Ilustraciones presentan el diámetro externo.
 Le illustrazioni mostrano il diametro esterno.

Ohrküretten | Cures auriculaires
 Ear cures | Cures auriculaires
 Curette auricolari



BUCK

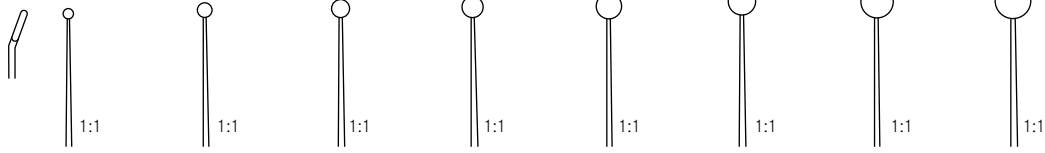

	Fig. 000	Fig. 00	Fig. 0	Fig. 1	Fig. 2	Fig. 3	Fig. 4	Fig. 5
165 mm - 6 1/2"	tk 50614-01	tk 50614-02	tk 50614-10	tk 50614-11	tk 50614-12	tk 50614-13	tk 50614-14	tk 50614-15

gebogen, stumpf
 curved, blunt

courbe, tranchante
 curva, cortante
 curva, smussa

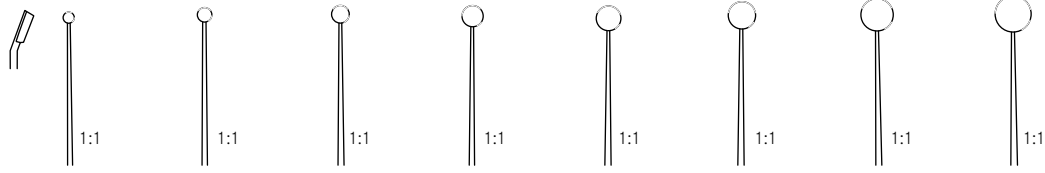

	Fig. 000	Fig. 00	Fig. 0	Fig. 1	Fig. 2	Fig. 3	Fig. 4	Fig. 5
165 mm - 6 1/2"	tk 50615-01	tk 50615-02	tk 50615-10	tk 50615-11	tk 50615-12	tk 50615-13	tk 50615-14	tk 50615-15

gebogen, scharf
 curved sharp

courbe, pointue
 curva, aguda
 curva, tagliente

1:1



Abbildungen zeigen den Außendurchmesser.
 Pictures show the outer diameter.

Illustrations représentent le diamètre externe.
 Ilustraciones presentan el diametro externo.
 Le illustrazioni mostrano il diametro esterno.

Ohrküretten und scharfe Löffel
Ear currettes and sharp spoons

Curettes auriculaires et cuillères tranchantes
Curetas y cucharillas auriculares cortantes
 Curette auricolari e cucchiari taglienti



LANGENBECK

130 mm - 5"

tk 50620-13

stumpf
blunt

mousse
roma
 smussa

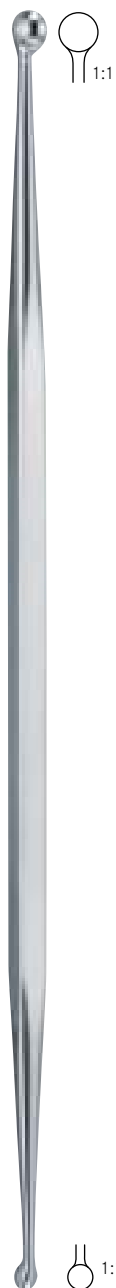

JANSEN

170 mm - 6³/₄"

tk 50622-17

scharf
sharp

tranchante
cortante
 acuta



GROSS

120 mm - 4³/₄"

tk 50623-12

scharf, voll
sharp, not fenestrated

tranchante, pleine
cortante, lleno
 acuta, pieno

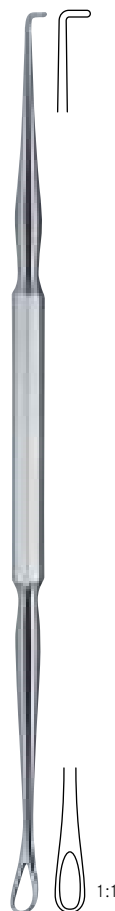

stumpf, gefenstert
blunt, fenestrated

mousse, fenêtrée
romas, fenestrada
 smussa, fenestrata

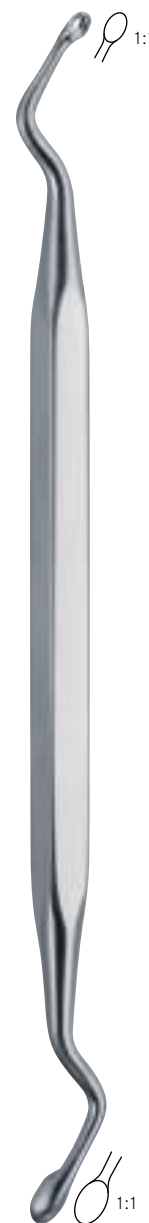

JANSEN

160 mm - 6¹/₄"

tk 50628-16

scharf
sharp

tranchante
cortante
 acuta

Ohrschlingen - Hakchen
Ear loops - hooks

Anses - crochets auriculaires
Asas - ganchos auriculares
Anse - uncini auricolari



1:2

BILLEAU

165 mm - 6 1/2"

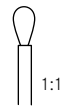

1:1

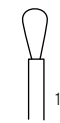

1:1

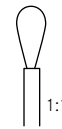

1:1

tk 50634-01	tk 50634-02	tk 50634-03
--------------------	--------------------	--------------------



1:2

LUCAE

140 mm - 5 1/2"



1:1



1:1

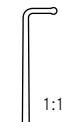

1:1

tk 50644-01	tk 50644-02	tk 50644-03
--------------------	--------------------	--------------------



1:2

WAGENER

140 mm - 5 1/2"



1:1



1:1



1:1



1:1



1:1



1:1



1:1

tk 50661-01	tk 50661-02	tk 50661-03	tk 50661-04	tk 50661-05	tk 50661-06	tk 50661-07
--------------------	--------------------	--------------------	--------------------	--------------------	--------------------	--------------------

Ohrhäkchen - Messer
Ear hooks - knives

Crochets - couteaux auriculaires
Ganchos - cuchillos auriculares
Uncini - coltelli auricolari

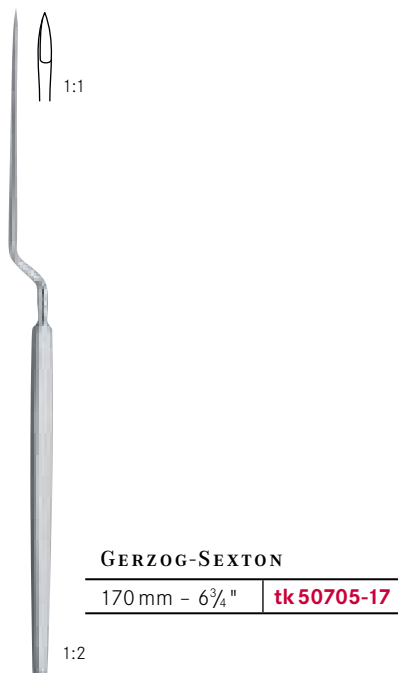
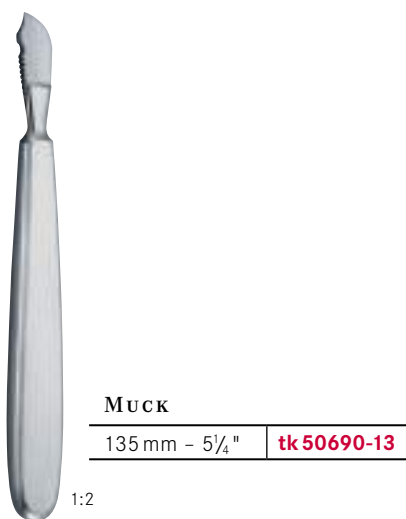
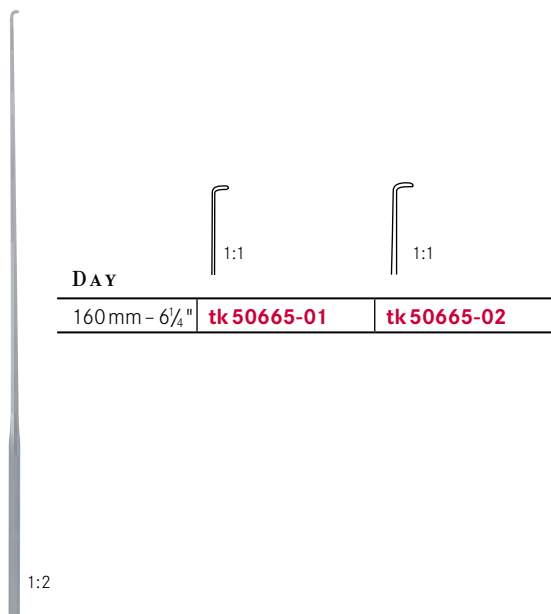

Parazentesenadeln
Paracentesis needles

Aiguilles de paracentèse
Agujas para paracentesis
Aghi per paracentesi



POLITZER
150 mm - 6"
tk 50710-15



GERZOG
160 mm - 6¼"
tk 50712-16



BUCK
160 mm - 6¼"
tk 50714-16



1:1

LUCAE

180 mm - 7" **tk 50761-18**



1:1

tk 50763-18



1:1

LUCAE
190 mm - 7½"
tk 50765-19



1:1

POLITZER
170 mm - 6¾"
tk 50757-16



1:1

POLITZER

160 mm - 6¼"
tk 50753-16

Nadel senkrecht
Needle vertical
Aiguille verticale
Aguja vertical
Ago verticale



1:1

160 mm - 6¼"
tk 50755-16

Nadel waagrecht
Needle horizontal
Aiguille horizontale
Aguja horizontal
Ago orizzontale

Ohrpolypenschnürer | Serre noeuds auriculaires
Ear polypus snares | *Polipótomos auriculares*
 Serranodi auricolari



	10 m - 33 ft.
0.2 mm Ø	tk 50319-20
0.3 mm Ø	tk 50319-30



0.2 mm Ø x 75 mm	tk 50320-20
0.3 mm Ø x 100 mm	tk 50320-30

in Bündeln mit 12 Stück
in bundles of 12 pieces
 en paquets de 12 pièces
en líos de 12 piezas
 pacchetto di 12 pezzi



KRAUSE
 160 mm - 6¼" | **tk 50311-16**



KRAUSE-VOSS
 160 mm - 6¼" | **tk 50313-16**



LANGE-WILDE
 170 mm - 6¾" | **tk 50315-17**

Ohrpolypenzangen
Ear polypus forceps

Pinces pour polypes auriculaires
Pinzas para pólipos auriculares
Pinze per polipi auricolari



LITTAUER

120 mm - 4³/₄" **tk 50403-12**

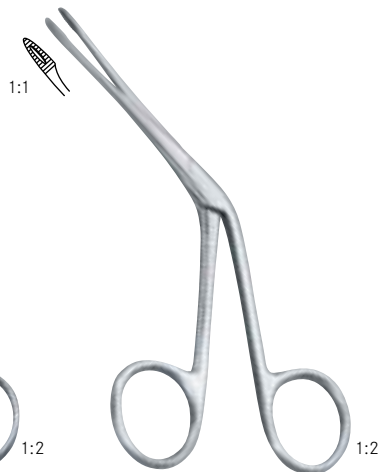

HARTMANN

120 mm - 4³/₄" **tk 50405-12**

feines Modell
delicate jaw
modèle fin
modelo fino
modello fino



HARTMANN

140 mm - 5¹/₂" **tk 50407-14**

normales Modell
normal jaw
modèle standard
modelo estandard
modello standard



QUIRE

105 mm - 4¹/₄" **tk 50419-10**

Fremdkörperhebel
Foreign body lever

Levier pour corps étrangers
Elevador para cuerpos extraños
Leva per corpi estranei



BUCK

115 mm - 4¹/₂" **tk 50417-11**

Fremdkörperzängchen
Foreign body forceps

Pince pour corps étrangers
Pinza para cuerpos extraños
Pinza per corpi estranei

Ohrzängchen | Pincés auriculaires
 Ear forceps | Pinzas auriculares
 Pinze auricolari

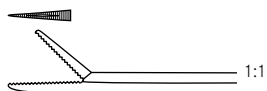

HARTMANN-WULLSTEIN
 x = 85 mm - 3 1/4" tk 50455-08

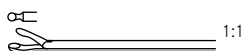

HARTMANN-WULLSTEIN
 1 mm Ø
 x = 85 mm - 3 1/4" tk 50457-08

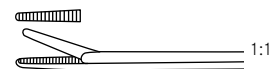

HARTMANN
 x = 85 mm - 3 1/4" tk 50459-08
 x = 140 mm - 5 1/2" tk 50459-14
 x = 160 mm - 6 1/4" tk 50459-16



HARTMANN
 x = 85 mm - 3 1/4" tk 50461-08
 x = 140 mm - 5 1/2" tk 50461-14

1x2

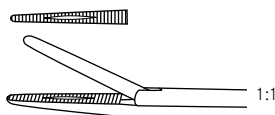

HARTMANN-NOYES
 x = 90 mm - 3 1/2" tk 50463-09



HARTMANN-WEINGÄRTNER
 x = 85 mm - 3 1/4" tk 50467-08



HARTMANN
 x = 85 mm - 3 1/4"
 2.0 mm Ø tk 50469-01
 2.5 mm Ø tk 50469-02
 3.0 mm Ø tk 50469-03

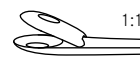

STRUEMPEL
 x = 85 mm - 3 1/4"
 0° tk 50472-08



45° tk 50472-45



90° tk 50472-90

Mikro-Ohrzängchen
Micro ear forceps

Micro pinces auriculaires
Micro-pinzas auriculares
 Micro-pinze auricolari



McGEE

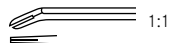

3.5 mm x 0.8 mm tk 50430-00

Drahtbiegezängchen
Wire bending forceps

Pince pour plier fils métalliques
Pinza para plegar alambres
 Pinza per piegare fili metallici

FULLER



80 mm - 3 1/4" tk 50434-01

Einführungszängchen für Teflonprothesen
Introducing forceps for teflon prosthesis

Pince pour introduction pour prothèses de téflon
Pinza para introducir para prótesis de teflon
 Pinza per introduzione di protesi in teflon

DIETER

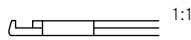

x = 80 mm - 3 1/4"

tk 50432-01

Hammerkopfzängchen
Malleus nipper

Pince pour l'os marteau
Pinza para cabezal del martillo
 Pinza per testa del martelletto

oben schneidend
up-cutting

coupe en haut
corte arriba
 tagliante in alto

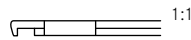

tk 50432-02

unten schneidend
down-cutting

coupe en bas
corte abajo
 tagliante in basso

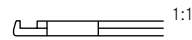

tk 50433-01

rechts schneidend
right-cutting

coupe à droite
corte derecha
 tagliante a destra

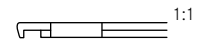

tk 50433-02



links schneidend
left-cutting

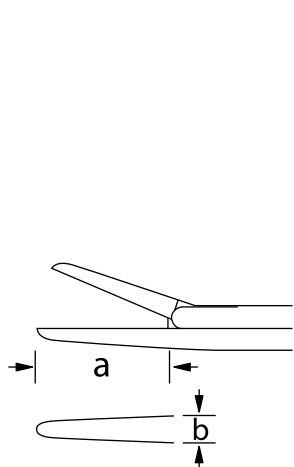

coupe à gauche
corte izquierda
 tagliante a sinistra



Mikro-Ohrzängchen | Micro pinces auriculaires
 Micro ear forceps | Micro-pinzas auriculares
 Micro-pinze auricolari



MINI MCGEE

	 1:1	 1:1
a x b	x = 75 mm - 3"	x = 75 mm - 3"
3.5 mm x 0.6 mm	tk 50421-01	tk 50421-02
	gerade, glatt <i>straight, smooth</i>	gerade, gerieft <i>straight, serrated</i>
	droit, lisse <i>recta, lisa</i>	droit, strié <i>recta, estriada</i>
	retta, liscia	retta, zigrinata

	 1:1	 1:1	 1:1
a x b	x = 75 mm - 3"	x = 75 mm - 3"	x = 75 mm - 3"
3.5 mm x 0.6 mm			tk 50421-03
4.0 mm x 0.8 mm	tk 50420-01	tk 50420-02	tk 50420-03
	gerade, glatt <i>straight, smooth</i>	gerade, gerieft <i>straight, serrated</i>	aufgebogen, gerieft <i>curved upwards, serrated</i>
	droit, lisse <i>recta, lisa</i>	droit, strié <i>recta, estriada</i>	coudé en haut, strié <i>curvada arriba, estriada</i>
	retta, liscio	retta, zigrinata	curvata in alto, zigrinata

	 1:1	 1:1	 1:1
a x b	x = 75 mm - 3"	x = 75 mm - 3"	x = 75 mm - 3"
3.5 mm x 0.6 mm	tk 50421-04	tk 50421-05	tk 50421-06
4.0 mm x 0.8 mm	tk 50420-04	tk 50420-05	tk 50420-06
	rechts gebogen, gerieft <i>curved to right, serrated</i>	links gebogen, gerieft <i>curved to left, serrated</i>	abwärts gebogen, gerieft <i>angled down, serrated</i>
	coudé à droite, strié <i>curvada a la derecha, estriada</i>	coudé à gauche, strié <i>curvada a la izquierda, estriada</i>	coudé en bas, strié <i>curvada a bajo, estriada</i>
	curvata a destra, zigrinata	curvata a sinistra, zigrinata	curvata in basso, zigrinata

Mikro-Löffelzängchen
Micro cup forceps

Micro pinces auriculaires à cuillère
Micro-pinzas auriculares a cucharilla
Micro-pinze auricolari a cucchiaio

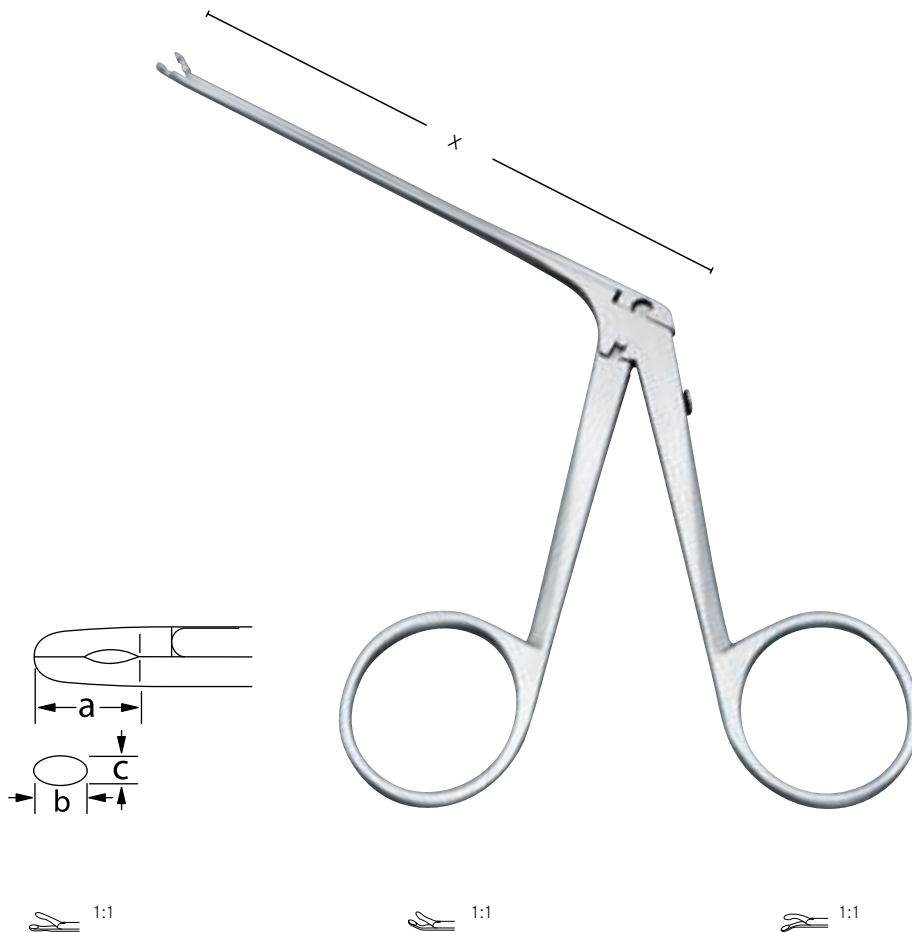

	x = 75 mm - 3"	x = 75 mm - 3"	x = 75 mm - 3"
a = 4.0 mm b = 1.0 mm x c = 0.9 mm	tk 50424-10	tk 50424-11	tk 50424-12

gerade, oval
straight, oval
droit, ovale
recta, oval
retta, ovale

aufgebogen, oval
curved upwards, oval
coudé en haut, ovale
curvada arriba, oval
curvata in alto, ovale

links gebogen, oval
curved to left, oval
coudé à gauche, ovale
curvada a la izquierda, oval
curvata a sinistra, ovale





	x = 75 mm - 3"	x = 75 mm - 3"
a = 4.0 mm b = 1.0 mm x c = 0.9 mm	tk 50424-13	tk 50424-14

rechts gebogen, oval
curved to right, oval
coudé à droite, ovale
curvada a la derecha, oval
curvata a destra, ovale

abwärts gebogen, oval
curved downwards, oval
coudé en bas, ovale
curvada a bajo, oval
curvata in basso, ovale

Mikro-Löffelzängchen | Micro pinces auriculaires à cuillère
 Micro cup forceps | Micro-pinzas auriculares a cucharilla
 Micro-pinze auricolari a cucchiaino







	 1:1	 1:1
	x = 80 mm - 3 1/4"	x = 80 mm - 3 1/4"
a = 3.5 mm b = 0.6 mm x c = 0.5 mm	tk 50425-01	tk 50425-02
a = 4.0 mm b = 1.0 mm x c = 0.9 mm	tk 50424-01	tk 50424-02
	gerade, oval <i>straight, oval</i> droit, ovale <i>recta, oval</i> retta, ovale	aufgebogen, oval <i>curved upwards, oval</i> coudé en haut, ovale <i>curvada arriba, oval</i> curvata in alto, ovale
	 1:1	 1:1
	x = 80 mm - 3 1/4"	x = 80 mm - 3 1/4"
a = 3.5 mm b = 0.6 mm x c = 0.5 mm	tk 50425-03	tk 50425-04
a = 4.0 mm b = 1.0 mm x c = 0.9 mm	tk 50424-03	tk 50424-04
	rechts gebogen, oval <i>curved to right, oval</i> coudé à droite, ovale <i>curvada a la derecha, oval</i> curvata a destra, ovale	links gebogen, oval <i>curved to left, oval</i> courbe à gauche, ovale <i>curvada a la izquierda, oval</i> curvata a sinistra, ovale

Mikro-Ohrscheren
Micro ear scissors

Micro ciseaux auriculaires
Micro-tijeras para oídos
Micro-forbici auricolari





BELUCCI	 1:1	 1:1
a x b	x = 75 mm - 3"	x = 75 mm - 3"
4.0 mm x 0.8 mm	tk 50426-07	tk 50426-02
sehr fein very fine	gerade, spitz/spitz straight, sharp/sharp	aufgebogen, stumpf/stumpf curved upwards, blunt/blunt
très fine muy fina	droit, pointue/pointue recta, aguda/aguda	courbées en haut, mousse/mousse curvada arriba, roma/roma
molto delicata	retta, acuta/acuta	curvata in alto, smussa/smussa



	 1:1	 1:1
a x b	x = 75 mm - 3"	x = 75 mm - 3"
4.0 mm x 0.8 mm	tk 50426-05	tk 50426-06
sehr fein very fine	rechts gebogen, spitz/spitz curved to right, sharp/sharp	links gebogen, spitz/spitz curved to left, sharp/sharp
très fine muy fina	coudé à droite, pointue/pointue curvada a la derecha, aguda/aguda	coudée à gauche, pointue/pointue curvada a la izquierda, aguda/aguda
molto delicata	curvata a destra, acuta/acuta	curvata a sinistra, acuta/acuta

	 1:1
a x b	x = 75 mm - 3"
4.0 mm x 0.8 mm	tk 50426-08
sehr fein very fine	gerade, spitz/stumpf straight, sharp/blunt
très fine muy fina	droit, pointue/mousse recta, aguda/roma
molto delicata	retta, acuta/smussa

Mikro-Ohrscheren | Micro ciseaux auriculaires
 Micro ear scissors | Micro-tijeras para oidos
 Micro-forbici auricolari





WULLSTEIN	 1:1	 1:1
a x b	x = 80 mm - 3/4"	x = 80 mm - 3/4"
4.0 mm x 0.8 mm	tk 50427-01	tk 50427-02
	gerade, spitz/spitz straight, sharp/sharp droit, pointue/pointue recta, aguda/aguda retta, acuta/acuta	aufgebogen, spitz/spitz curved upwards, sharp/sharp coudée en haut, pointue/pointue curvada arriba, aguda/aguda curvata in alto, acuta/acuta

WULLSTEIN	 1:1	 1:1
a x b	x = 80 mm - 3/4"	x = 80 mm - 3/4"
4.0 mm x 0.8 mm	tk 50427-03	tk 50427-04
	rechts gebogen, spitz/spitz curved to right, sharp/sharp coudé à droite, pointue/pointue curvada a la derecha, aguda/aguda curvata a destra, acuta/acuta	links gebogen, spitz/spitz curved to left, sharp/sharp coudée à gauche, pointue/pointue curvado a la izquierda, aguda/aguda curvata a sinistra, acuta/acuta

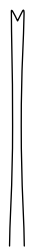

Ohr Mikro-Raspatorien und Sonden
Micro ear-raspatories and probes

Micro rugines et sondes auriculaires
Micro-sondas y raspatorios auriculares
 Micro-raspatori e sonde auricolari



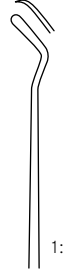

PLESTER	 1:1	 1:1	 1:1
	160mm - 6 1/4"	tk 50530-00	tk 50531-00

Führungsgabel <i>Wire guide</i>	Raspatorium <i>Raspatory</i>	Elevatorium <i>Elevator</i>
Fourchette d'introduction <i>Tenedor guía</i>	Rugine <i>Raspatorio</i>	Élévateur <i>Elevador</i>
Forchetta guida	Raspatorio	Elevatorio

160mm - 6 1/4"	 1:1	 1:1	 1:1
	1.8 mm	1.0 mm	
	tk 50533-00	tk 50534-00	tk 50535-00

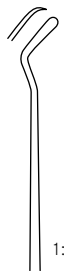
Raspatorium <i>Raspatory</i>	Raspatorium <i>Raspatory</i>	Dissektor, doppelt links gebogen <i>Dissector, double curved left</i>
Rugine <i>Raspatorio</i>	Rugine <i>Raspatorio</i>	Dissecteur, double courbe à gauche <i>Disector, doble curvado a la izquierda</i>
Raspatorio	Raspatorio	Dissettore doppio curvato a sinistra

160mm - 6 1/4"	 1:1	 1:1	 1:1
	tk 50536-00	tk 50537-00	

Dissektor, doppelt rechts gebogen <i>Dissector, double curved right</i>	Handinstrument zum Andrücken von Drahtprothesen <i>Instrument for placing wire prothesis</i>
Dissecteur, double courbe à droite <i>Disector, doble curvado a la derecha</i>	Instrument pour mettre en place des protheses en fils métalliques <i>Instrumento para posicionar protèsis de alambre</i>
Dissettore, doppio curvato a destra	Strumento per posizionare prothesi di fili metallici



HOUSE	
	160mm - 6 1/4"
3.5 mm	tk 50571-01
4.0 mm	tk 50571-02
4.5 mm	tk 50571-03
5.0 mm	tk 50571-04

Messsonde
Measuring rod
 Sonde à mesurer
Sonda para medir
 Sonda per misurare



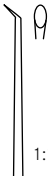
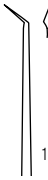

Ohrsichelmesser – Rundschnittmesser
Ear sickleknives – Circular cutting knife

Couteaux faucilles – Couteaux ronds
Cuchillos en forma de hoz – Cuchillos redondos
Coltelli auricolari





	 1:1	 1:1	 1:1	 1:1
ROSEN				
	1.5 mm Ø – 90°	45°	45°	
160mm – 6¼"	tk 50538-00	tk 50539-01	tk 50539-02	tk 50539-03

Rundschnittmesser <i>Circular cutting knife</i> Couteau rond <i>Cuchillo redondo</i> Coltello rotondo	Trommelfellmesser <i>Tympanum knife</i> Couteau pour le tympan <i>Cuchillo para el timpano</i> Coltello per timpani	Lanzenmesser <i>Lancet knife</i> Couteau lancéolaire <i>Cuchillo lanceolado</i> Coltello lancelato	Lanzenmesser <i>Lancet knife</i> Couteau lancéolaire <i>Cuchillo lanceolado</i> Coltello lancelato
--	--	---	---

	 1:1	 1:1	 1:1	 1:1
SCHUHKNECHT				
160mm – 6¼"	tk 50550-01	tk 50550-02	tk 50550-03	tk 50550-04

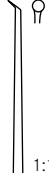
Rollermesser, parallel <i>Roller knife, parallel</i> Couteau à lame, tournante, verticale <i>Cuchillo redondo, vertical</i> Coltello rotondo, parallelo	Rollermesser, rechtwinklig <i>Roller knife, right angled</i> Couteau à lame, tournante, horizontale <i>Cuchillo redondo, horizontal</i> Coltello rotondo, orizzontale	Sichelmesser, leicht gebogen <i>Sickle knife, slightly curved</i> Couteau faucille, légèrement courbe <i>Cuchillo de hoz, ligeramente curvado</i> Coltello a ferma di falce, leggermente curvo	Diszisionsmesser, gerade <i>Discision knife, straight</i> Couteau à discision, droit <i>Cuchillo de discición, recto</i> Coltello di dissezione, retto
--	--	---	---

	 1:1	 1:1	 1:1	 1:1
PLESTER			ZÖLLNER	
160mm – 6¼"	tk 50550-06	45°	1 mm	1 mm
		3.0 mm Ø	160mm – 6¼"	tk 50567-01
		2.6 mm Ø		tk 50577-01
		2.0 mm Ø		
		1.5 mm Ø		
		1.0 mm Ø		

Lappenmesser <i>Flap knife</i> Couteau à lambeaux <i>Cuchillo para lobulos</i> Coltello per stacci	Rundschnittmesser <i>Circular cutting knife</i> Couteau rond <i>Cuchillo redondo</i> Coltello rotondo	Raspatorium <i>Raspatory</i> Rugine <i>Raspatorio</i> Raspatorio	Raspatorium <i>Raspatory</i> Rugine <i>Raspatorio</i> Raspatorio
---	--	---	---

Mikro-Ohrnadeln und Häkchen
Micro ear-needles and hooks

Micro-aiguilles et crochets auriculaires
Micro-agujas y ganchos auriculares
Micro-uncini ed aghi auricolari

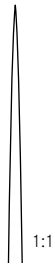

160 mm - 6 1/4"	160 mm - 6 1/4"
tk 50543-01	tk 50543-02

Nadel fein, gerade, spitz
Needle fine, straight, sharp
Aiguille fine, droite, pointue
Aguja fina, recta, aguda
Ago fino, retto, acuto

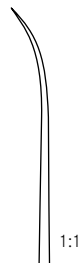

160 mm - 6 1/4"	160 mm - 6 1/4"
tk 50543-02	tk 50543-03

Nadel, leicht gebogen, spitz
Needle, slightly curved, sharp
Aiguille, légèrement courbe, pointue
Aguja, ligeramente curva, aguda
Ago, legeremente curvato, acuto



160 mm - 6 1/4"	160 mm - 6 1/4"
tk 50543-03	

Nadel, stark gebogen, spitz
Needle, strong curved, sharp
Aiguille, très courbe, pointue
Aguja, muy curvada, aguda
Ago, fortemente curvato, acuto



SHAMBAUGH

	160 mm - 6 1/4"	160 mm - 6 1/4"
	45°	90°
0.4 mm	tk 50544-04	tk 50545-04
0.6 mm	tk 50544-06	tk 50545-06
0.8 mm	tk 50544-08	tk 50545-08
1.0 mm	tk 50544-10	tk 50545-10

Häkchen, abgewinkelt
Hook, angled
Crochet, coudé
Gancho, acodado
Uncino, angolato

	160 mm - 6 1/4"
1.0 mm	tk 50546-10
2.5 mm	tk 50546-25

Häkchen, retrograd gebogen
Hook, retrograd
Crochet, courbe retrograde
Gancho, acodado, retrogrado
Uncino, curvato reterogrado

	160 mm - 6 1/4"
0.6 mm	tk 50547-01

Häkchen, retrograd gebogen
Hook, retrograd
Crochet, courbe retrograde
Gancho, acodado, retrogrado
Uncino, curvato reterogrado

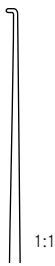

0.4 mm - 90°	tk 50548-01
--------------	--------------------

Fussplattenhäkchen, abgewinkelt, stumpf
Foot plate hook, angled, blunt
Crochet pour la platine de l'étrier, mousse
Gancho, para placa de aido, roma
Uncino per placca di piede, smusso

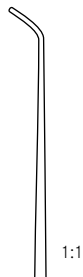

1.0 mm - 45°	tk 50549-01
--------------	--------------------

Antrum Häkchen, aufgewinkelt, stumpf
Antrum hook, angled, blunt
Crochet pour l'antrum, coudé, mousse
Gancho para el antrum, acodado, roma
Uncino per antrum, angolato in alto, smusso



BARBARA

tk 50553-01	tk 50553-02	tk 50553-03	tk 50553-04
spitz/gerade <i>sharp/straight</i>	stumpf/gewinkelt <i>blunt/angled</i>	spitz/leicht gebogen <i>sharp/slightly curved</i>	spitz/stark gebogen <i>sharp/strong curved</i>
pointue/droite <i>aguda/recta</i> acuto/retta	mousse/coudée <i>roma/angulada</i> smusso/angolato	pointue/légèrement courbe <i>aguda/ligeramente curva</i> acuto/legeremente curvato	pointue/très courbe <i>aguda/muy curva</i> acuto/fortemente curvato

Mikro-Ohrnadeln und Häkchen
Micro ear-needles and hooks

Micro-aiguilles et crochets auriculaires
Micro-agujas y ganchos auriculares
Micro-uncini ed aghi auricolari

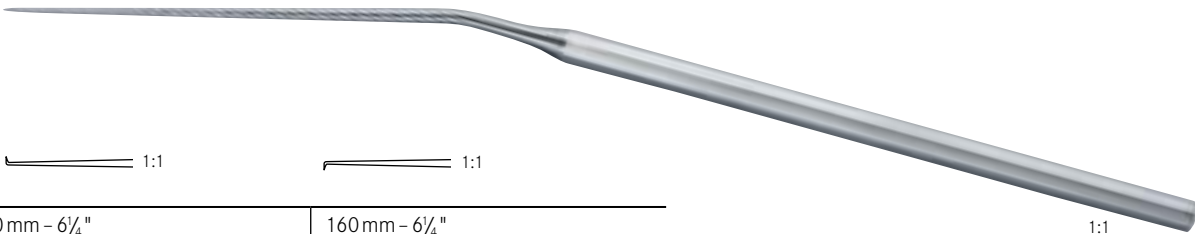

SHAMBAUGH

	160 mm - 6 1/4"	160 mm - 6 1/4"
	90°	90°
0.3 mm	tk 50558-03	tk 50559-03
0.6 mm	tk 50558-06	tk 50559-06
1.0 mm	tk 50558-10	tk 50559-10

Häkchen, nach oben gebogen
Hook, curved up
Crochet, coudé en haut
Gancho, curvado arriba
Uncino, curvato in alto

Häkchen, nach unten gebogen
Hook, curved down
Crochet, coudé en bas
Gancho, curvado a bajo
Uncino, curvato in basso

MCGEE

	160 mm - 6 1/4"	160 mm - 6 1/4"
0.5 mm	tk 50560-05	tk 50561-05
1.0 mm	tk 50560-10	tk 50561-10

Häkchen, rund, nach oben gebogen
Hook, round, curved up
Crochet, courbé ronde, vers le haut
Gancho, redondo, curvado arriba
Uncino, rotondo, curvato in alto

Häkchen, rund, nach unten gebogen
Hook, round, curved down
Crochet, courbé ronde vers le bas
Gancho, redondo, curvado arriba
Uncino, rotondo, curvato in basso

BARBARA

	0.5 mm
155 mm - 6"	tk 50562-01

ROSEN

	0.5 mm
160 mm - 6 1/4"	tk 50562-04

Nadel, leicht gebogen
Needle, slightly curved

Aiguille, légèrement courbée
Aguja, ligeramente, curvado
Ago, legermente curvato

MCGEE

	160 mm - 6 1/4"	160 mm - 6 1/4"	160 mm - 6 1/4"	160 mm - 6 1/4"
	25°	25°	45°	45°
0.3 mm	tk 50563-03	tk 50564-03	tk 50565-03	tk 50566-03
0.6 mm	tk 50563-06	tk 50564-06	tk 50565-06	tk 50566-06
1.0 mm	tk 50563-10	tk 50564-10	tk 50565-10	tk 50566-10

Häkchen, nach oben gebogen
Hook, curved up
Crochet, coudé en haut
Gancho, curvado arriba
Uncino, curvato in alto

Häkchen, nach unten gebogen
Hook, curved down
Crochet, coudé en bas
Gancho, curvado a bajo
Uncino, curvato in basso





Häkchen, nach oben gebogen
Hook, curved up
Crochet, coudé en haut
Gancho, curvado arriba
Uncino, curvato in alto

Häkchen, nach unten gebogen
Hook, curved down
Crochet, coudé en bas
Gancho, curvado a bajo
Uncino, curvato in basso

Mikro-Ohrraspatorien
Micro ear-raspatories

Micro-raspateurs auriculaires
Micro-raspatorias auriculares
Micro-raspatori auricolari

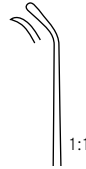

FISCH			
 1:1	 1:1	 1:1	 1:1
155 mm - 6"	155 mm - 6"	155 mm - 6"	155 mm - 6"
tk 50568-01	tk 50568-02	tk 50569-01	tk 50569-02
rechts abgewinkelt <i>angled to the right</i> coudé à droite <i>angulado por la derecha</i> angolato a destra	links abgewinkelt <i>angled to the left</i> coudé à gauche <i>angulado por la izquierda</i> angolato a sinistra	rechts abgewinkelt <i>angled to the right</i> coudé à droite <i>angulado por la derecha</i> angolato a destra	links abgewinkelt <i>angled to the left</i> coudé à gauche <i>angulado por la izquierda</i> angolato a sinistra



tk 50590-00

Rack für 8 Mikro-Ohr-Instrumente mit Sechskantgriff
Rack for 8 each micro ear instruments with hexagonal or octagonal handle
 Etagère pour 8 micro-instruments avec manches hexagonales o octogonales
Soporte para 8 micro-instrumentos con mangos hexagonales o octogonales
 Supporto per 8 strumenti micro con manico esagonale e ottagonale

Mikro-Ohrlöffel | Micro-curettes auriculaires
 Micro ear-spoons | Micro-curetas auriculares
 Micro-cucchiai auricolari



HOUSE

170 mm - 6³/₄" tk 50573-01

Löffel, stark gebogen
 Spoon, strong curved

Curette, fortement coudée
 Cureta, muy curvada
 Cucchaio, fortemente curvato

170 mm - 6³/₄" tk 50573-02

Löffel, leicht gebogen
 Spoon, slightly curved

Curette, légèrement coudée
 Cureta, ligeramente curvada
 Cucchaio, legeremente curvato



SHEA

	1.5 mm x 2.5 mm	1.5 mm x 2.5 mm
160 mm - 6 ¹ / ₄ "	tk 50572-01	tk 50572-02

gerade
 straight
 droits
 recta
 retto

gebogen
 curved
 courbe
 curva
 curvo

Mikro-Ohrlöffel | Micro-curettes auriculaires
 Micro ear-spoons | Micro-curetas auriculares
 Micro-cucchiai auricolari

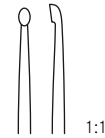
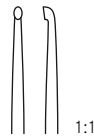

HOUSE

	1.0 mm Ø und 1.2 mm Ø	1.5 mm Ø und 1.8 mm Ø
150 mm - 6"	tk 50574-01	tk 50574-02

Löffel, leicht gebogen
 Spoon, slightly curved
 Curette, légèrement coudée
 Cureta, ligeramente curvada
 Cucchaio, leggermente curvato

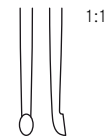
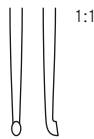

HOUSE

	1.0 mm Ø und 1.2 mm Ø	1.5 mm Ø und 1.8 mm Ø
150 mm - 6"	tk 50575-01	tk 50575-02

Löffel stark gebogen
 Spoon strong curved
 Curette fortement coudée
 Cureta, muy curvada
 Cucchaio, fortemente curvato

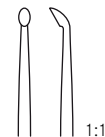
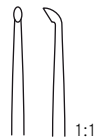

Mikro-Ohrmeißel und Hämmer
Micro ear-chisels and hammers

Micro burins et marteaux auriculaires
Micro cincels y martillos para orejas
 Micro scalpelli e martelli per orecchio

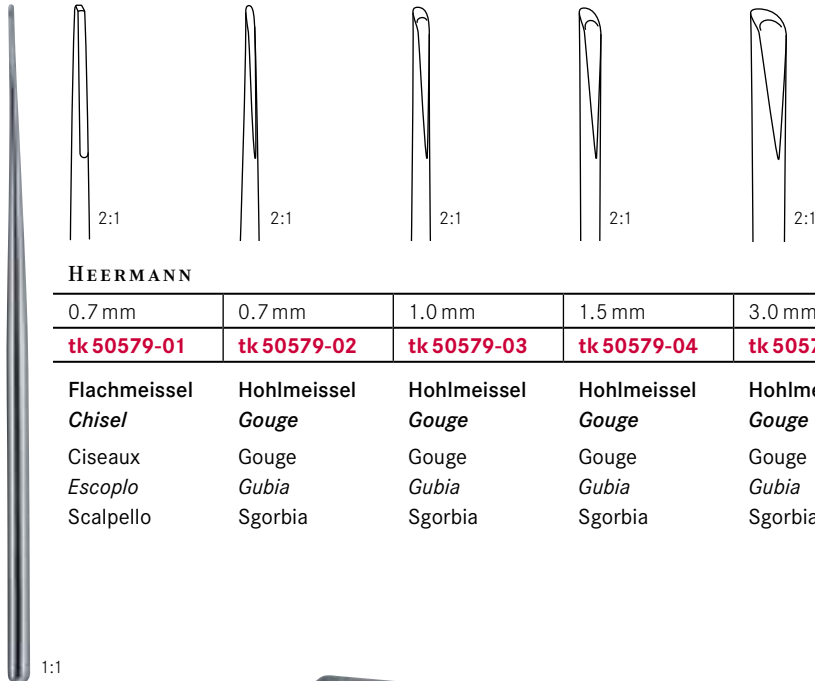

HEERMANN

0.7 mm	0.7 mm	1.0 mm	1.5 mm	3.0 mm
tk 50579-01	tk 50579-02	tk 50579-03	tk 50579-04	tk 50579-05
Flachmeißel <i>Chisel</i>	Hohlmeißel <i>Gouge</i>	Hohlmeißel <i>Gouge</i>	Hohlmeißel <i>Gouge</i>	Hohlmeißel <i>Gouge</i>
Ciseaux <i>Escoplo</i>	Gouge <i>Gubia</i>	Gouge <i>Gubia</i>	Gouge <i>Gubia</i>	Gouge <i>Gubia</i>
Scalpello	Sgorbia	Sgorbia	Sgorbia	Sgorbia

COTTLE

	240 g
185 mm - 7 1/4"	tk 50581-19

Hammer, Metall
Metal hammer
 Maillet en métal
Martillo, de metal
 Martello, acciaio

HEERMANN

tk 50580-10

Handgriff für Meißel (tk 50579-01 - tk 50579-05)
Handle for chisels (tk 50579-01 - tk 50579-05)

Manche pour ciseaux (tk 50579-01 - tk 50579-05)

Mango para escoplos (tk 50579-01 - tk 50579-05)

Manico per scalpelli/sgorbie (tk 50579-01 - tk 50579-05)

Ohrspatorien
Ear-raspatories

Raspateurs auriculaires
Raspatorias auriculares
Raspatori auricolari

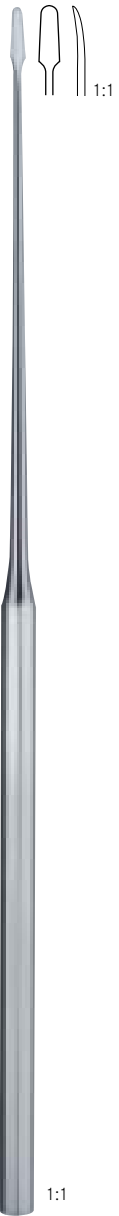

WULLSTEIN

160 mm - 6 1/4"	tk 50578-01	tk 50578-02
-----------------	--------------------	--------------------

gerade	gebogen
straight	curved
droite	courbe
recta	curva
rette	curvo



ROSEN

	1.5 mm
175 mm - 7"	tk 50783-00

bajonettförmig
bayonet shaped
en forme de baionette
en forma de bayoneta
forma a baionetta





LEMPERT

tk 50784-02
160 mm - 6 1/4"
3.0 mm

Ohr-Knochenstanzen
Bone-rongeurs

Rongeurs auriculaires
Pinzas osteótomos auriculares
Conchotomi auricolari



CITELLI	 1:1	 1:1
	170 mm - 6¾"	2.2 mm
x = 60 mm	tk 50491-02	tk 50491-03



KERRISON				
	200 mm - 8"	3 x 3 mm	4 x 4 mm	5 x 5 mm
x = 80 mm	tk 51251-00	tk 51251-01	tk 51251-02	tk 51251-03

Ohr-Knochenstanzen
Bone-rongeurs

Rongeurs auriculaires
Pinzas osteótomos auriculares
Conchotomi auricolari

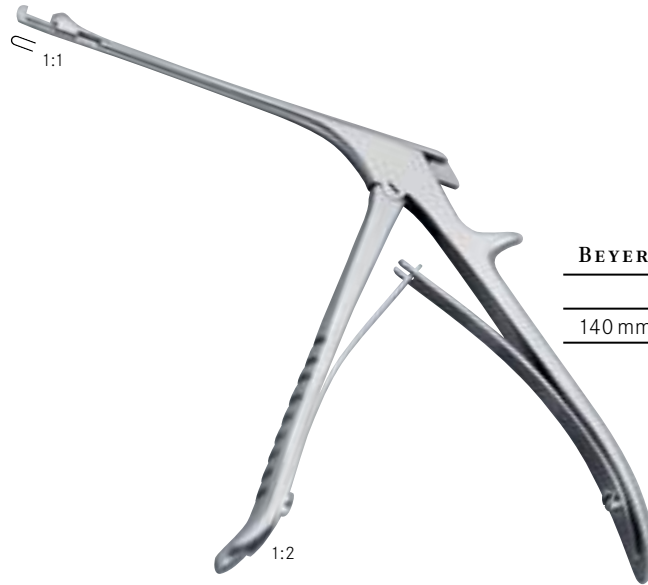

BEYER	
	1 mm
140 mm - 5½"	tk 50494-14



BEYER	
	2 mm
190 mm - 7½"	tk 50493-19

Bohrer | Fraises
 Burrs | Brocas
 Perforatori

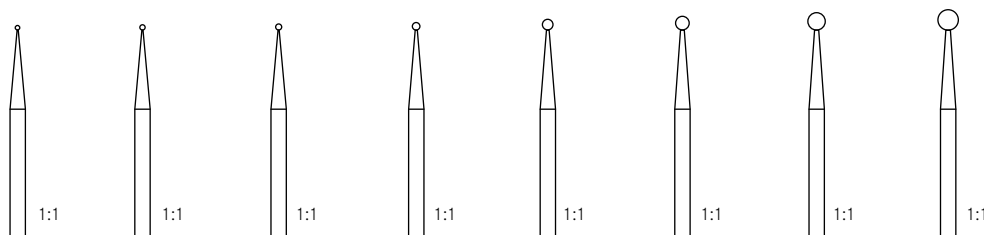

„ROSEN“-BOHRER

	0.6 mm Ø	0.7 mm Ø	0.8 mm Ø	1.0 mm Ø	1.4 mm Ø	1.8 mm Ø	2.3 mm Ø	2.7 mm Ø
70 mm - 2¾"	tk 52814-06	tk 52814-07	tk 52814-08	tk 52814-10	tk 52814-14	tk 52814-18	tk 52814-23	tk 52814-27

„Rosen“-Bohrer, 70 mm lang, Schaft-Ø 2.35 mm, rostfrei
 “Rosen” burrs, 70 mm long, shank diameter 2.35 mm, stainless

Fraises de «Rosen», 70 mm de long, Ø de tige 2.35 mm, inoxydables
 Brocas “Rosen”, largo 70 mm, vástago-Ø 2.35 mm, inoxidable
 Perforatori “Rosen”, 70 mm lungo, asta Ø 2.35 mm, inossidabili

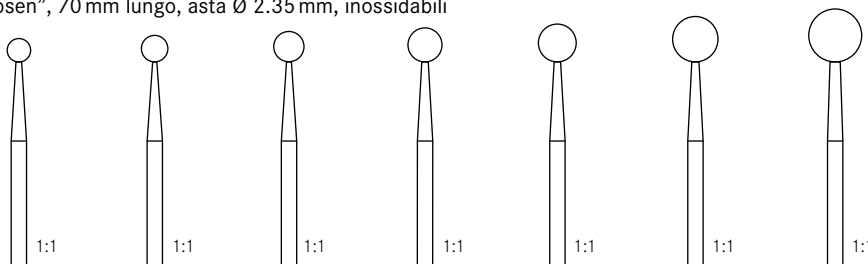

	3.1 mm Ø	3.5 mm Ø	4.0 mm Ø	4.5 mm Ø	5.0 mm Ø	6.0 mm Ø	7.0 mm Ø
70 mm - 2¾"	tk 52814-31	tk 52814-35	tk 52814-40	tk 52814-45	tk 52814-50	tk 52814-60	tk 52814-70

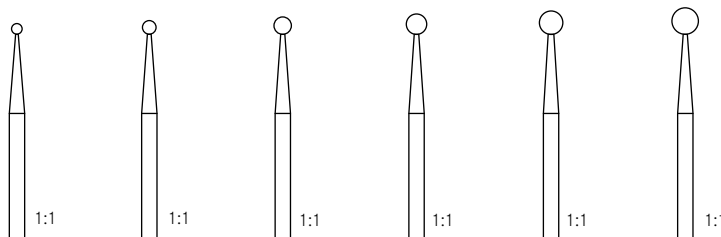

„ROSEN“-BOHRER

	1.4 mm Ø	1.8 mm Ø	2.3 mm Ø	2.7 mm Ø	3.1 mm Ø	3.5 mm Ø
95 mm - 3¾"	tk 52816-14	tk 52816-18	tk 52816-23	tk 52816-27	tk 52816-31	tk 52816-35

„Rosen“-Bohrer, 95 mm lang, Schaft-Ø 2.35 mm, rostfrei
 “Rosen” burrs, 95 mm long, shank diameter 2.35 mm, stainless

Fraises de «Rosen», 95 mm de long, Ø de tige 2.35 mm, inoxydables
 Brocas “Rosen”, largo 95 mm, vástago-Ø 2.35 mm, inoxidable
 Perforatori “Rosen”, 95 mm lungo, asta Ø 2.35 mm, inossidabili

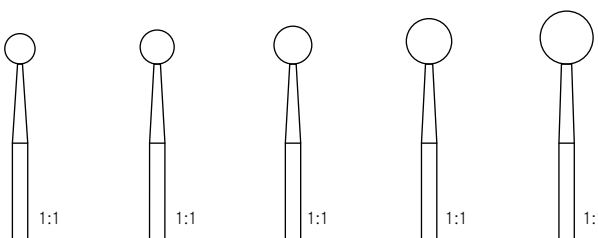

	4.0 mm Ø	4.5 mm Ø	5.0 mm Ø	6.0 mm Ø	7.0 mm Ø
95 mm - 3¾"	tk 52816-40	tk 52816-45	tk 52816-50	tk 52816-60	tk 52816-70

Bohrer Burrs	Fraises Brocas Perforatori
-----------------	----------------------------------

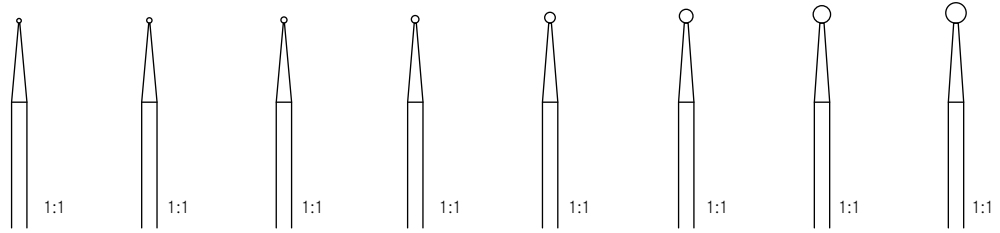
DIAMANTBOHRER

	0.6 mm Ø	0.7 mm Ø	0.8 mm Ø	1.0 mm Ø	1.5 mm Ø	1.8 mm Ø	2.3 mm Ø	2.7 mm Ø
70 mm - 2¾"	tk 52810-06	tk 52810-07	tk 52810-08	tk 52810-10	tk 52810-15	tk 52810-18	tk 52810-23	tk 52810-27

Diamantbohrer, 70 mm lang, Schaft-Ø 2.35 mm

Diamond dust polishing burrs, 70 mm long, shank diameter 2.35 mm

Fraises à polir, diamantées, 70 mm de long, Ø de tige 2.35 mm

Brocas diamantadas, largo 70 mm, vástago-Ø 2.35 mm

Perforatori diamantati, 70 mm lungo, asta Ø 2.35 mm

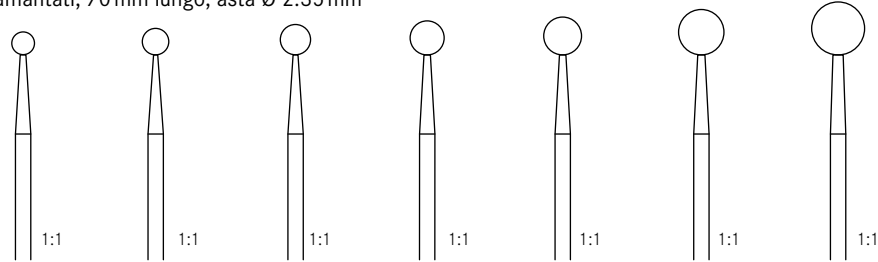

	3.0 mm Ø	3.5 mm Ø	4.0 mm Ø	4.5 mm Ø	5.0 mm Ø	6.0 mm Ø	7.0 mm Ø
70 mm - 2¾"	tk 52810-30	tk 52810-35	tk 52810-40	tk 52810-45	tk 52810-50	tk 52810-60	tk 52810-70

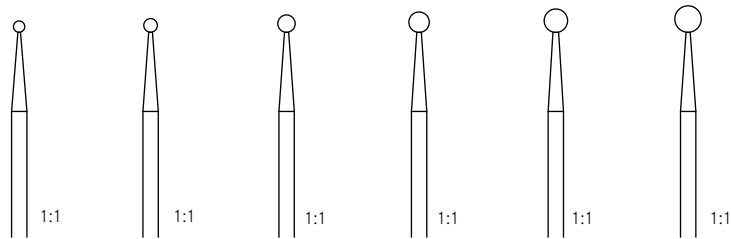
DIAMANTBOHRER

	1.5 mm Ø	1.8 mm Ø	2.3 mm Ø	2.7 mm Ø	3.0 mm Ø	3.5 mm Ø
95 mm - 3¾"	tk 52812-15	tk 52812-18	tk 52812-23	tk 52812-27	tk 52812-30	tk 52812-35

Diamantbohrer, 95 mm lang, Schaft-Ø 2.35 mm

Diamond dust polishing burrs, 95 mm long, shank diameter 2.35 mm

Fraises à polir, diamantées, 95 mm de long, Ø de tige 2.35 mm

Brocas diamantadas, largo 95 mm, vástago-Ø 2.35 mm

Perforatori diamantati, 95 mm lungo, asta Ø 2.35 mm

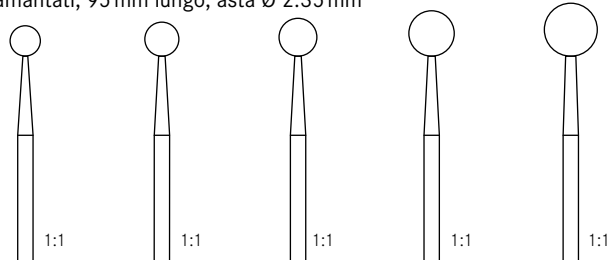

	4.0 mm Ø	4.5 mm Ø	5.0 mm Ø	6.0 mm Ø	7.0 mm Ø
95 mm - 3¾"	tk 52812-40	tk 52812-45	tk 52812-50	tk 52812-60	tk 52812-70

Nasenspekula | Spéculums nasaux
 Nasal specula | Especulos nasales
 Specoli nasali



1:2

THUDICHUM
(GOLDSMITH)



	Fig. 5	Fig. 6	Fig. 7
	19 mm x 9.5 mm	20 mm x 10.5 mm	21 mm x 11.5 mm
65 mm - 2½"	tk 50808-01	tk 50808-02	tk 50808-03



1:2

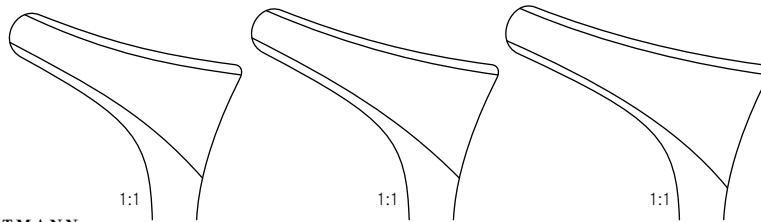

HARTMANN

160 mm - 6¼"	tk 50812-01	tk 50812-02	tk 50812-03
--------------	--------------------	--------------------	--------------------



1:2

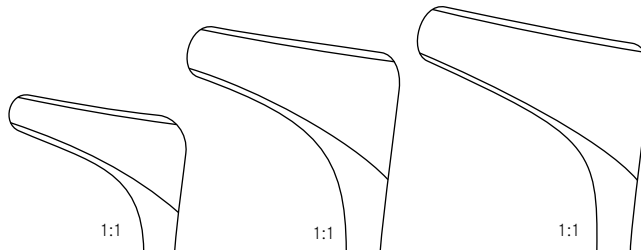

HARTMANN-HALLE

150 mm - 6"	tk 50813-01	tk 50813-02	tk 50813-03
-------------	--------------------	--------------------	--------------------



Alle Nasenspekula sind optional auch mit Feststellschraube erhältlich
 All nasal specula are also available with locking screw
 Tous les spéculems nasaux sont aussi disponible avec une vis de fixation
 Todos los especulos nasales son también disponibles con un tornillo de fijación
 Tutti gli speculi nasali sono disponibili anche con vite di fassaggio



Nasenspekula
Nasal specula

Spéculums nasaux
Especulos nasales
Specoli nasali



1:2

TIECK-HALLE

135 mm - 5 1/4"

tk 50822-13

für Säuglinge
for babies
pour nourrissons
para lactantes
per lattanti

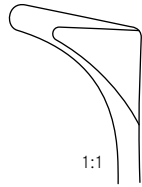

1:1



1:2

SCHWARZ

140 mm - 5 1/2"

tk 50811-14

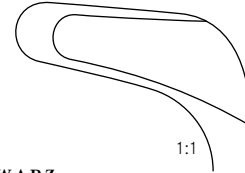

1:1



1:2

KILLIAN

	x = 35 mm	x = 50 mm
130 mm - 5"	tk 50828-01	tk 50828-02

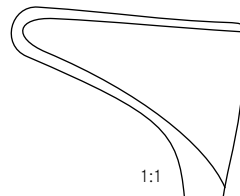

1:1

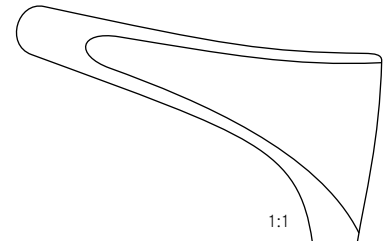

1:1

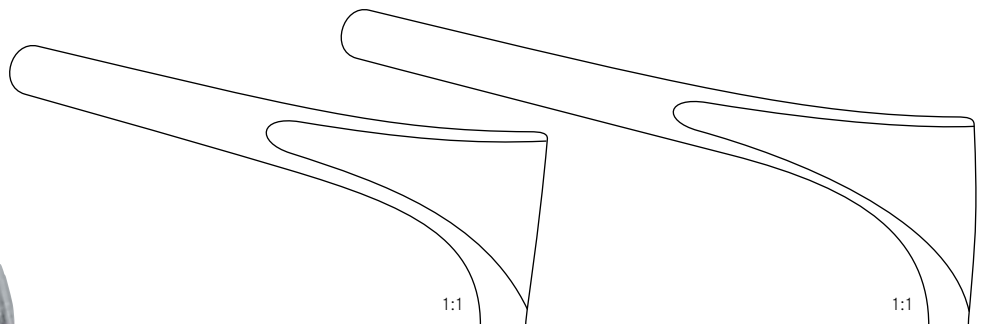

1:1

	x = 75 mm	x = 90 mm
130 mm - 5"	tk 50828-03	tk 50828-04

Nasenspekula | Spéculums nasaux
Nasal specula | *Especulos nasales*
 Specoli nasali

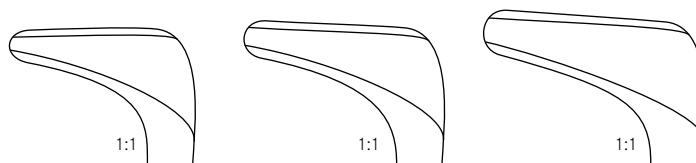

BECKMANN

150 mm - 6"	tk 50830-01	tk 50830-02	tk 50830-03
-------------	--------------------	--------------------	--------------------

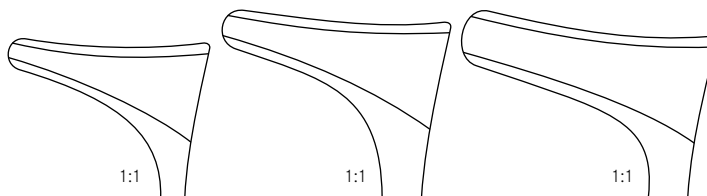

MOD. WIEN

145 mm - 5 3/4"	tk 50834-01	tk 50834-02	tk 50834-03
-----------------	--------------------	--------------------	--------------------

Nasenspekula | Spéculums nasaux
Nasal specula | *Especulos nasales*
 Specoli nasali

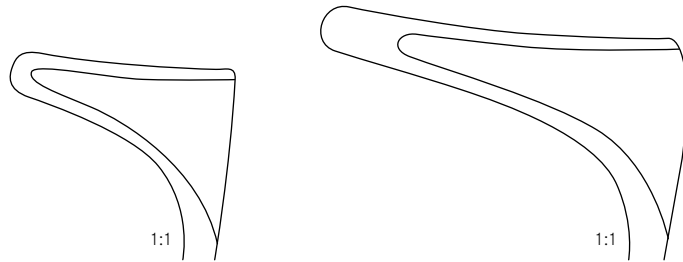

COTTLE

	x = 35 mm	x = 50 mm
150 mm - 6"	tk 50836-35	tk 50836-50

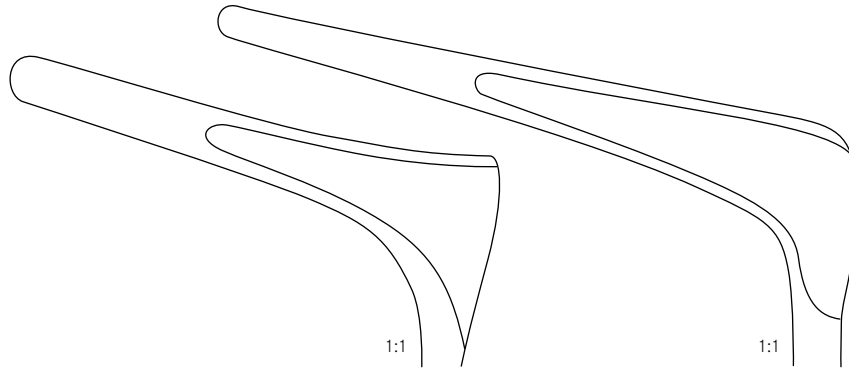

	x = 75 mm	x = 90 mm
150 mm - 6"	tk 50836-75	tk 50836-90

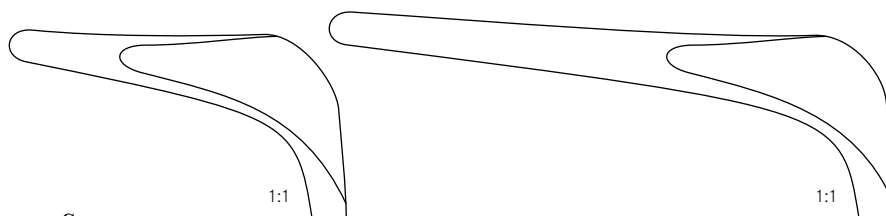

COTTLE

	x = 45 mm	x = 75 mm
140 mm - 5½"	tk 50840-45	tk 50840-75

schwarz verchromt
black, chrome plated
 chromé en noir
chromado en negro
 cromato nero

Nasenpolypenzangen – Septumzangen
Nasal polypus and septum forceps

Pinces à polypes et la cloison nasale
Pinzas para pólipos y el tabique nasal
 Pinze per polipi e setto nasale



WESTMACOTT
 200 mm - 8" **tk 51065-20**



LUBET-BARBON
 200 mm - 8" **tk 51066-20**



HARTMANN
 160 mm - 6¼" **tk 51067-16**
 200 mm - 8" **tk 51071-20**

Nasentamponzange
Nasal dressing forceps

Pince à pansement pour le nez
Pinza nasale para tamponiamento
 Pinza per tamponamento nasale



NOYES
 x = 110 mm - 3½" **tk 50465-09**
 1x2

Nasenpolypenzangen – Septumzangen
Nasal polypus and septum forceps

Pinces à polypes et la cloison nasale
Pinzas para pólipos y el tabique nasal
Pinze per polipi e setto nasale



TILLEY

140 mm - 5½" **tk 51068-14**



HEYMANN-KNIGHT

180 mm - 7" **tk 51069-18**





CRAIG

180 mm - 7" **tk 51116-18**

Nasenpolypenzangen
Nasal polypus

Pinces à polypes nasales
Pinzas para pólipos nasales
Pinze per polipi nasali



	 1:1	 1:1	 1:1
HEYMANN			
180 mm - 7"	tk 51095-01	tk 51095-02	tk 51095-03



LITTAUER
180 mm - 7" **tk 51079-18**



KNIGHT
180 mm - 7" **tk 51099-18**

Scharfe Nasenzangen
Nasal cutting forceps

Pincés coupantes pour le nez
Pinzas nasales cortantes
Pinze taglianti per naso

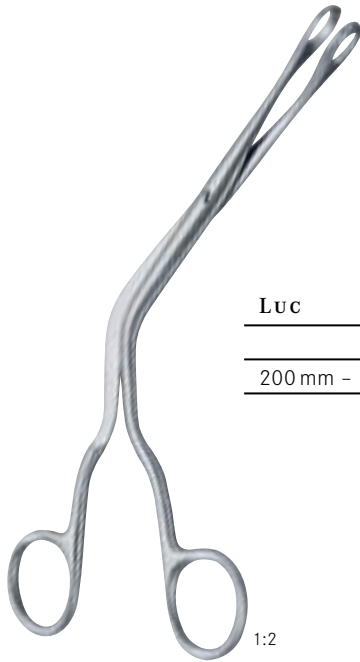

Luc	1:1		1:1	
	Fig. 1	Fig. 2	Fig. 1	Fig. 2
200 mm - 8"	tk51121-01	tk51121-02	tk51120-01	tk51120-02
	gefenstert <i>fenestrated</i> fenêtré <i>fenestrado</i> finestrato		voll <i>plaine</i> pleine <i>lleno</i> pieno	

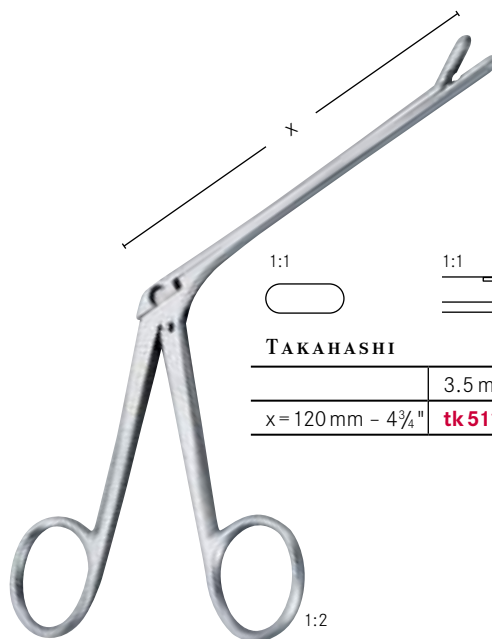

TAKAHASHI		
	3.5 mm x 10 mm	3.5 mm x 10 mm
x = 120 mm - 4¾"	tk51131-12	tk51133-12

Scharfe Nasenzangen
Nasal cutting forceps

Pinces coupantes pour le nez
Pinzas nasales cortantes
Pinze taglianti per naso



BRUENINGS

190 mm - 7½"



1:1



1:1



1:1



1:1

tk 51123-01

tk 51123-02

tk 51123-03

tk 51123-04

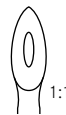

1:1

WEIL

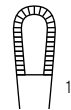

1:1

WATSON-WILLIAMS



1:1

x = 120 mm - 4¾"

tk 51147-12

tk 51141-10

tk 51143-12

Scharfe Nasenzangen
Nasal cutting forceps

Pincés coupantes pour le nez
Pinzas nasales cortantes
Pinze taglianti per naso

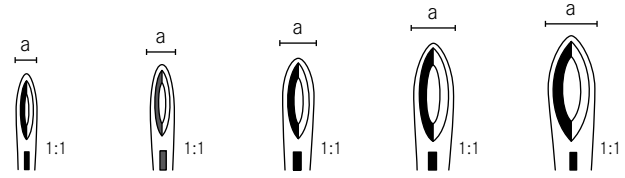
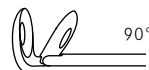

**WEIL-
BLAKESLEY**

	Fig. 1	Fig. 2	Fig. 3	Fig. 4	Fig. 5
	a = 3.0 mm	a = 3.5 mm	a = 4.5 mm	a = 5.0 mm	a = 5.5 mm
x = 120 mm - 4 ³ / ₄ "	tk51155-01	tk51155-02	tk51155-03	tk51155-04	tk51155-05

x = 120 mm - 4 ³ / ₄ "	tk51158-01	tk51158-02	tk51158-03	tk51158-04	
--	-------------------	-------------------	-------------------	-------------------	--

x = 120 mm - 4 ³ / ₄ "	tk51159-01	tk51159-02	tk51159-03		
--	-------------------	-------------------	-------------------	--	--

	Fig. 1	Fig. 2	Fig. 3	Fig. 4	Fig. 5
	a = 3.0 mm	a = 3.5 mm	a = 4.5 mm	a = 5.0 mm	a = 5.5 mm
x = 180 mm - 7"	tk51160-01	tk51160-02	tk51160-03	tk51160-04	tk51160-05

x = 180 mm - 7"	tk51161-01	tk51161-02	tk51161-03	tk51161-04	
-----------------	-------------------	-------------------	-------------------	-------------------	--

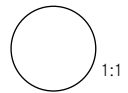

HARTMANN

x = 120 mm - 4 ³ / ₄ "	tk51165-01	tk51165-02	tk51165-03	tk51165-04
--	-------------------	-------------------	-------------------	-------------------

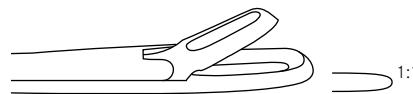

MYLES

	Fig. 1	Fig. 2	Fig. 3
	2.0 x 10.0 mm	2.5 x 12.0 mm	3.0 x 14.0 mm
x = 120 mm - 4 ³ / ₄ "	tk51162-01	tk51162-02	tk51162-03

Scharfe Nasenzangen | Pincas coupantes pour le nez
 Nasal cutting forceps | Pinzas nasales cortantes
 Pinze taglianti per naso



1:2

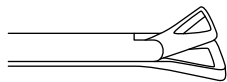

SCHMEDEN

x = 120 mm - 4 3/4"



1:1

tk 51171-11



1:1

tk 51171-12



1:1

tk 51171-13

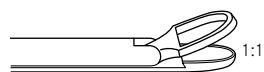

1:1

TOMATI

x = 120 mm - 4 3/4"

tk 51173-12

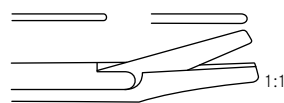

1:1

STRUYCKEN

0.9 mm

1.2 mm

x = 120 mm - 4 3/4"

tk 51174-01

tk 51174-02



1:1

HENKE

x = 120 mm - 4 3/4"

tk 51176-01

Nasenschere | Ciseaux nasales
 Nasal scissors | Tijera nasal
 Forbice nasale

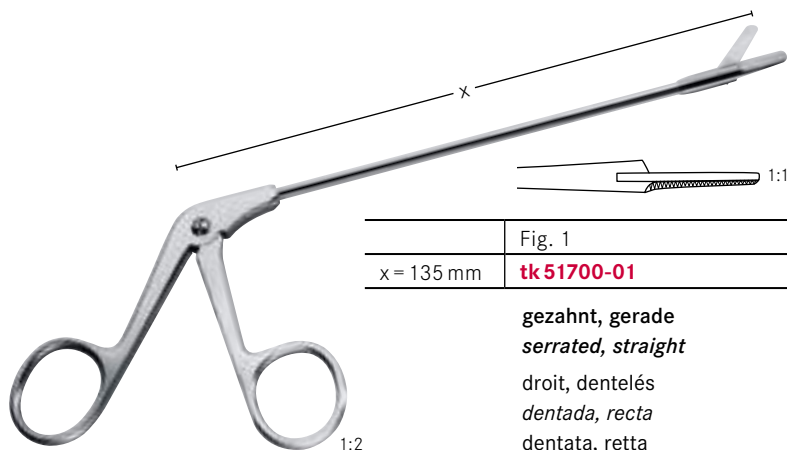

1:2

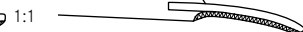

	Fig. 1	Fig. 2	Fig. 3
x = 135 mm	tk 51700-01	tk 51700-02	tk 51700-03

gezahnt, gerade
 serrated, straight

droit, dentelés
 dentada, recta
 dentata, retta

gezahnt, rechts
 serrated, right

dentelés, droites
 dentada, derecha
 dentata, destra

gezahnt, links
 serrated, left

dentelés, gauche
 dentada, izquierda
 dentata, sinistra

Scharfe Nasenzangen
Nasal cutting forceps

Pinces coupantes pour le nez
Pinzas nasales cortantes
Pinze taglianti per naso



	y = 3 mm
x = 100 mm - 4"	tk 51720-03

gerade vertikal, doppelt beweglich
straight vertical, double action
droit vertical, double action
recta, vertical, doble acción
retta, verticale, doppio movimento



	y = 3 mm
x = 100 mm - 4"	tk 51722-03

gerade hor., doppelt beweglich
straight hor., double action
droit horizontal, double action
recta, horizontal, doble acción
retta oriz., doppio movimento

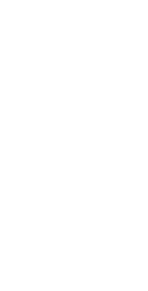

	y = 3 mm
x = 100 mm - 4"	tk 51723-03

gerade hor., einfach beweglich, kurz
straight hor., single action, short
droit hor., action simple, court
recta, hor., acción simple, corto
retta, oriz., movimento sing., corto



	y = 3 mm
x = 100 mm - 4"	tk 51724-03

45° vertikal, doppelt beweglich
45° vertical, double action
45° vertical, double action
45° vertical, doble acción
45° verticale, doppio movimento



	y = 3 mm
x = 100 mm - 4"	tk 51727-03

45° hor., doppelt beweglich
45° hor., double action
45° hor., double action
45° hor., doble acción
45° oriz., doppio movimento



	y = 3 mm
x = 100 mm - 4"	tk 51726-03

45° vert., einfach beweglich, kurz
45° vert., single action, short
45° vert., action simple, court
45° vert., acción simple, corto
45° vert., movimento sing., corto



	y = 3 mm
x = 100 mm - 4"	tk 51730-03

70° vertikal, doppelt beweglich
70° vertical, double action
70° vertical, double action
70° vertical, doble acción
70° verticale, doppio movimento



	y = 3 mm
x = 100 mm - 4"	tk 51732-03

70° hor., doppelt beweglich
70° hor., double action
70° hor., double action
70° hor., doble acción
70° oriz., doppio movimento



	y = 3 mm
x = 100 mm - 4"	tk 51740-03

110° hor., doppelt beweglich
110° hor., double action
110° hor., double action
110° hor., doble acción
110° oriz., doppio movimento

	y = 3 mm
x = 100 mm - 4"	tk 51731-03

70° vert., einfach beweglich, kurz
70° vert., single action, short
70° vert., action simple, court
70° vert., acción simple, corto
70° vert., movimento sing., corto

	y = 3 mm
x = 100 mm - 4"	tk 51734-03

70° hor., einfach beweglich
70° hor., single action
70° hor., action simple, court
70° hor., acción simple, corto
70° oriz., movimento sing., corto

Scharfe Nasenzangen
Nasal cutting forceps

Pinces coupantes pour le nez
Pinzas nasales cortantes
 Pinze taglianti per naso

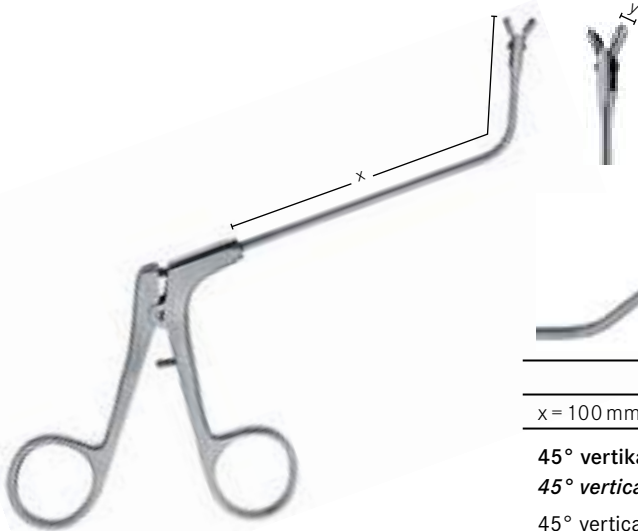

45° vertikal, doppelt beweglich
45° vertical, double action
 45° vertical, double action
45° vertical, doble acción
 45° verticale, doppio movimento

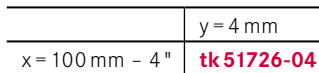

45° vertikal, einfach beweglich, kurz
45° vertical, single action, short short
 45° vertical, action simple, court
45° vertical, acción simple, corto
 45° verticale, movimento singolo, corta



45° hor., doppelt beweglich, kurz
45° hor., double action, short
 45° hor., double action, court
45° hor., acción doble, corto
 45° oriz., movimento, corta



70° vertikal, doppelt beweglich
70° vertical, double action
 70° vertical, double action
70° vertical, doble acción
 70° verticale, doppio movimento

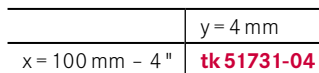

70° vertikal, einfach beweglich, kurz
70° vertical, single action, short short
 70° vertical, action simple, court
70° vertical, acción simple, corto
 70° verticale, movimento singolo, corta



70° hor., doppelt beweglich, kurz
70° hor., double action, short
 70° hor., double action, court
70° hor., acción doble, corto
 70° oriz., movimento, corta

Zirkular Stanze
Circular forceps

Pince circulaire
Pinza circular
Pinza a taglio circolare

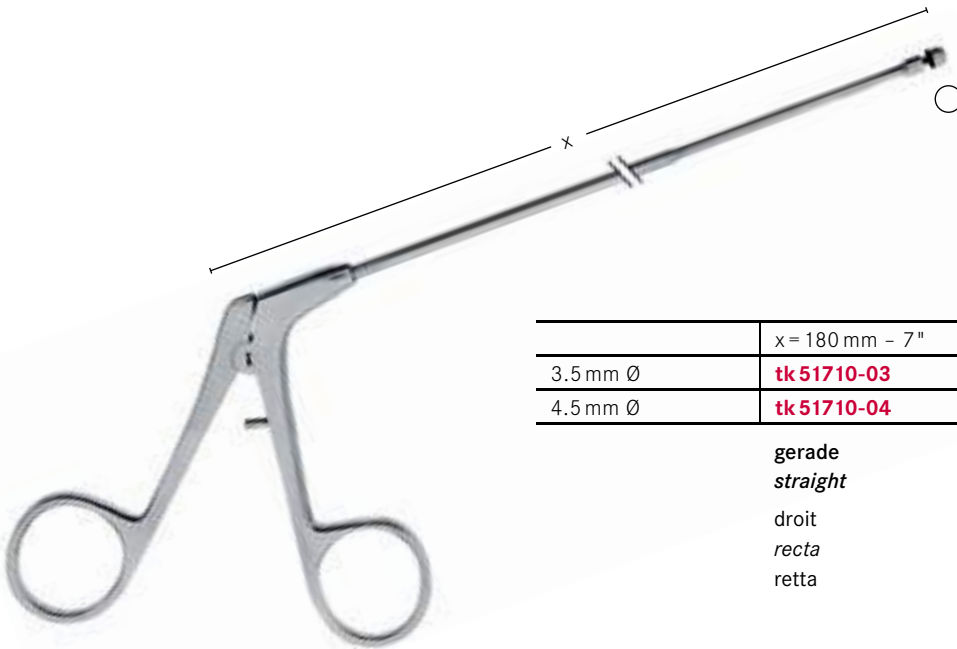

	x = 180 mm - 7"	x = 180 mm - 7"
3.5 mm Ø	tk51710-03	tk51711-03
4.5 mm Ø	tk51710-04	tk51711-04

gerade
straight

droit
recta
retta

aufgebogen
curved upwards

coudé en haut
curvada arriba
curvata in alto

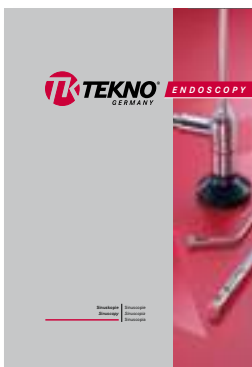

Bitte fordern Sie unseren Spezialkatalog für Sinuskopie an.
Please ask for our special for sinuscopy catalogue.

Veuillez demander pour notre catalogue spécial pour la sinuscopie.

Por favor preguntan para el catalogo especial para la sinuscopie.

Per favore domandate per il nostro catalogo speciale per sinuscopia.

Antrumstanze | Pince pour l'antrum
 Antrum punch | Pinza antrum
 Pinze antrum



x = 100 mm	Fig. 1	Fig. 2	Fig. 3
1.5 mm x 4.5 mm	tk 51175-01	tk 51175-02	tk 51175-03

rückwärts nach oben schneidend
backward, up-cutting
 retrograde coupe en haut
retrograda corte arriba
 retrograda tagliente in alto

rückwärts nach rechts schneidend
backward, cut to the right
 retrograde coupe à droite
retrograda corte a la derecha
 retrograda tagliente a destra

rückwärts nach links schneidend
backward, cut to the left
 retrograde coupe à gauche
retrograda corte a la izquierda
 retrograda tagliente a sinistra

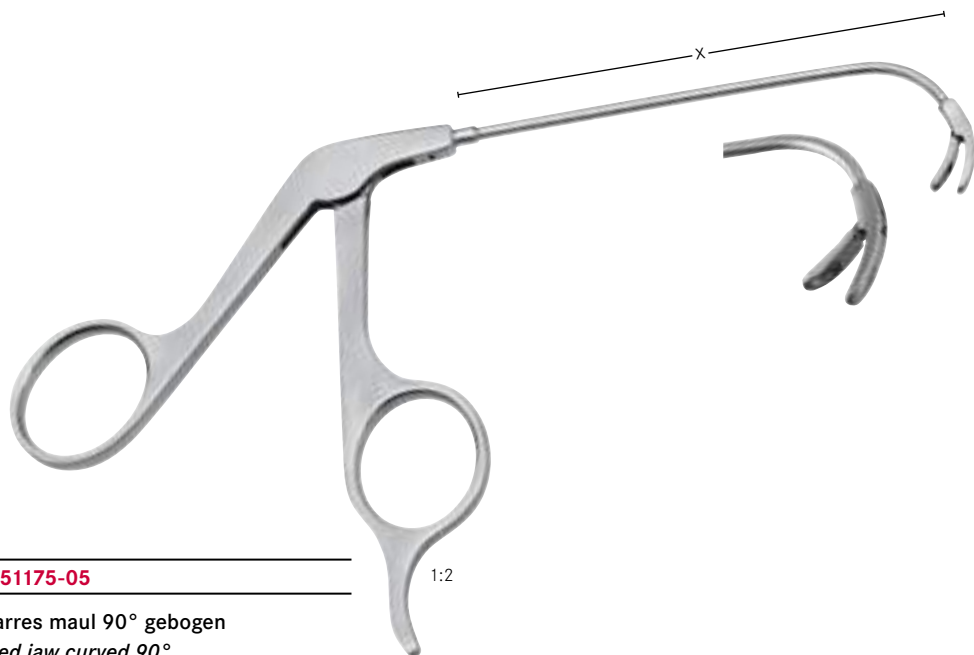

HEUWIESER

x = 100 mm	tk 51175-05
------------	--------------------

starres mauel 90° gebogen
fixed jaw curved 90°
 morso fix, courbe de 90°
boca fija, curva de 90°
 morsi fissi curvi 90°

Keilbeinstanzen
Sphenoid bone punches

Pinces pour le sinus sphénoïdal
Pinzas para esfenoïdes
Pinze sfenoidali taglienti



HAJEK	HAJEK-KOFLER
x = 140 mm - 5½"	x = 140 mm - 5½"
4 mm x 4 mm	3.5 mm x 3.5 mm
tk 51194-13	tk 51196-12

HAJEK	HAJEK-KOFLER
x = 140 mm - 5½"	x = 140 mm - 5½"
4 mm x 4 mm	3.5 mm x 3.5 mm
tk 51195-13	tk 51197-12

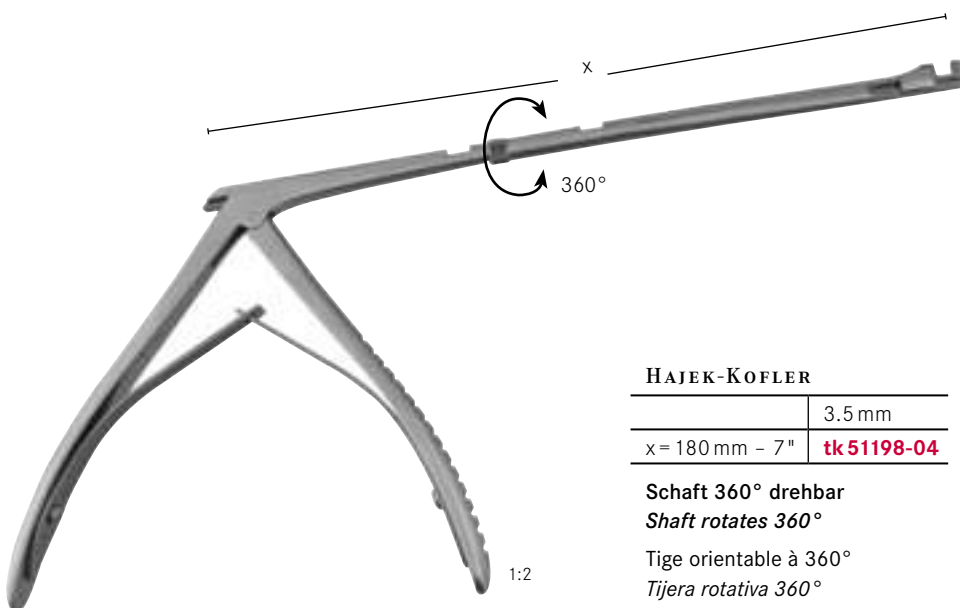

HAJEK-KOFLER	
	3.5 mm
x = 180 mm - 7"	tk 51198-04

Schaft 360° drehbar
Shaft rotates 360°

Tige orientable à 360°

Tijera rotativa 360°

Asta girevole 360°

Keilbeinstanzen
Sphenoid bone punches

Pinces pour sinus sphénoïdal
Pinzas para esfenoides
Pinze sfenoidali taglienti

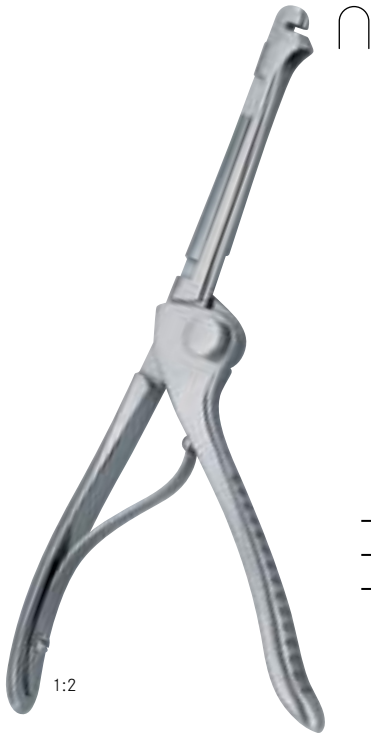



HAJEK-CLAUS
200 mm - 8"
tk 51245-20

1:2





CITELLI

	 1:1	 1:1
170 mm - 6¾"	2.2 mm	3.0 mm
x = 60 mm	tk 50491-02	tk 50491-03

1:2



KERRISON

	 1:1	 1:1	 1:1
x = 90 mm - 3½"	4 mm x 4 mm	5 mm x 5 mm	6 mm x 6 mm
200 mm - 8"	tk 51251-01	tk 51251-02	tk 51251-03

1:2

Nasenpolypenschnürer
Nasal polypus snares

Serre noeuds pour polypes
Polipótomos nasales
Serranodi nasali



0.3 mm Ø x 100 mm **tk 50320-30**

in Bündeln mit 12 Stück
in bundles of 12 pieces
en paquets de 12 pièces
en liós de 12 piezas
pacchetto di 12 pezzi



KRAUSE

260 mm - 10¼" **tk 50323-26**



KRAUSE-VOSS

260 mm - 10¼" **tk 50325-26**

mit 2 Aufsätzen
with 2 inserts
avec 2 guide-anses
con 2 guías
con 2 guide ansa



LANGE-WILDE

240 mm - 9½" **tk 50328-24**

Nasenmesser | Bistouris pour nez
 Nasal knives | Cuchillos nasales
 Bisturi per naso

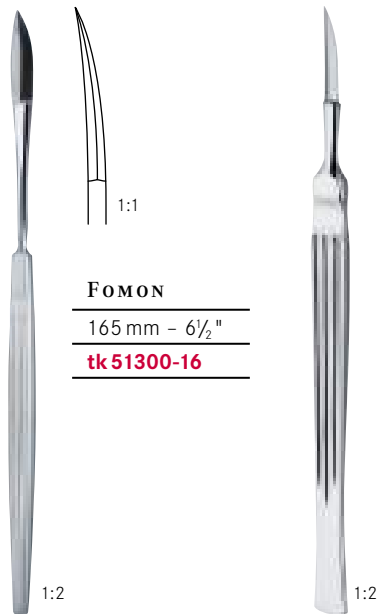

FOMON

165 mm - 6 1/2"

tk 51300-16

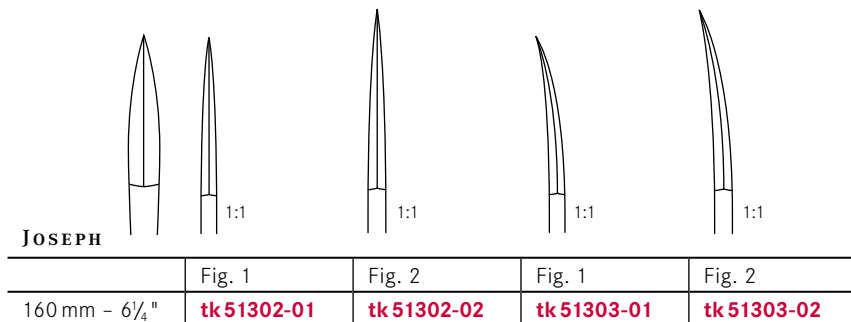

JOSEPH

	Fig. 1	Fig. 2	Fig. 1	Fig. 2
160 mm - 6 1/4"	tk 51302-01	tk 51302-02	tk 51303-01	tk 51303-02

scharf/spitz gerade
 sharp/sharp straight
 tranchant/pointu droit
 cortante/agudo recta
 acuto retto

gebogen
 curved
 courbe
 curva
 curvo

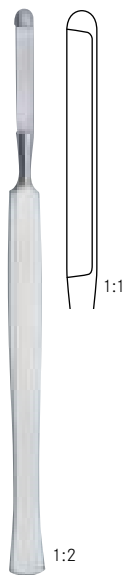

JOSEPH

140 mm - 5 1/2"

tk 51306-15



COTTLE

150 mm - 6"

tk 51308-15



JOSEPH

175 mm - 7"

tk 51335-03



BRUENINGS

165 mm - 6 1/2"

tk 51310-00

tk 51310-01

Ersatzklinge
 Spare blade

Lame de rechange
 Hoja de recambio
 Lama di ricambio

Nasenmesser
Nasal knives

Bistouris pour nez
Cuchillos nasales
Bisturi per naso



FREER
190 mm - 6 1/2" **tk 51350-01** **tk 51350-02**

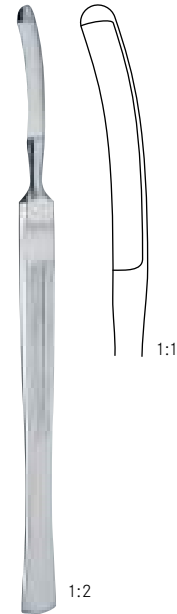

CONVERSE
160 mm - 6 1/4" **tk 51355-01**



FREER
150 mm - 6" **tk 51342-12**



FREER
150 mm - 6" **tk 51344-15**



FREER
150 mm - 6" **tk 51346-15**

Tonsillennmesser | Couteaux à tonsils
Tonsil knives | *Bisturis para amigdales*
 Bisturi per tonsille



FREER

210mm - 8 1/4" **tk 51361-01** | **tk 51361-02**



200 mm - 8"

tk 51330-11

Sichelmesser
Sickle knife

Couteau à faucille
Cuchillo falciforme
 Coltello a forma di falce



BRUENINGS

230 mm - 9"

tk 51315-23

1:2



ABRAHAM

220mm - 8 3/4"

tk 51317-22

1:2

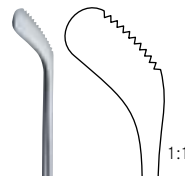

FISCHER

230 mm - 9"

tk 51323-23

1:2



200 mm - 8"

tk 51329-20

scharf
sharp
 tranchant
cortante
 acuto

1:2

Antrumküretten
Antrum curettes

Curettes d'antrum
Curetas para el antrum
Curette per antrum

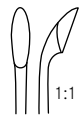
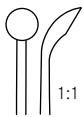

200 mm - 8"

tk 50621-04

200 mm - 8"

tk 50621-05

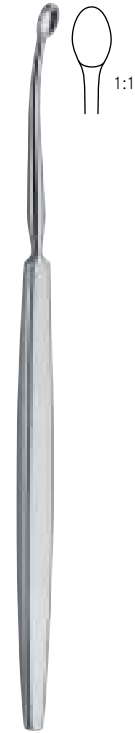

200 mm - 8"

7 mm x 11 mm

tk 50621-01



PRATT

210 mm - 8 1/4"

tk 50621-22



FAULKNER

210 mm - 8 1/4"

tk 51364-21



COAKLEY

200 mm - 8"

tk 51368-12



1:2

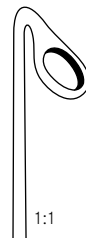

COAKLEY

	Fig. 1	Fig. 2	Fig. 3	Fig. 4	Fig. 5	Fig. 6
170 mm - 6 3/4"	tk 51366-01	tk 51366-02	tk 51366-03	tk 51366-04	tk 51366-05	tk 51366-06
tk 51366-00	x	x	x	x	x	x

Satz
Set
Jeu
Juego
Serie

Septum elevatorien - Raspatorien
Septum elevators - raspatories

Elevateurs - rugines pour la cloison nasale
Elevadores - legras para el tabique nasal
 Elevatori - periostotomi per setto

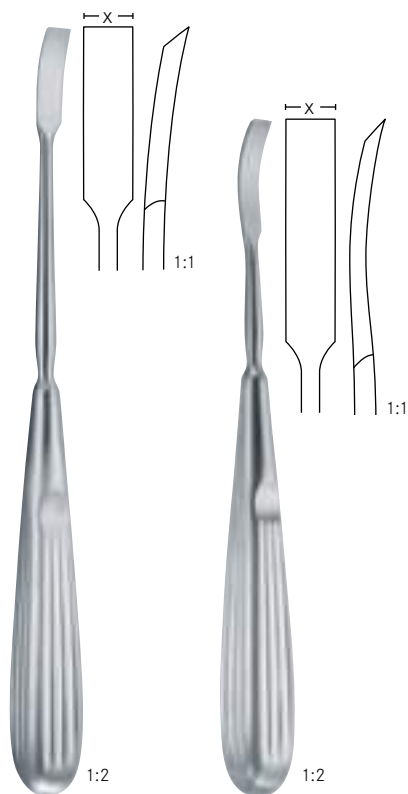

LEMPERT

	205 mm - 8"	180 mm - 7"
x = 6 mm	tk 50787-20	tk 50789-17



FREER

	x = 4 mm
160 mm - 6 1/4"	tk 50770-16



COTTLE

	x = 8 mm
190 mm - 7 1/2"	tk 51607-19

scharf
 sharp
 tranchant
 cortante
 acuta

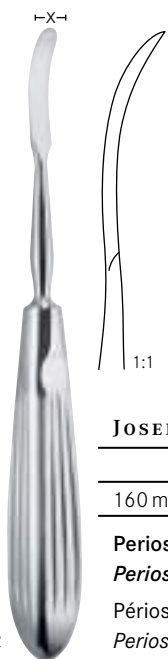

JOSEPH

	x = 5 mm
160 mm - 6 1/4"	tk 51613-16

Periost Elevatorien
Periostal elevators
 Périostotome
Periostotomo
 Periostotomo



SEWALL

200 mm - 8"	tk 51610-20
-------------	--------------------

Antrum Elevatorium
Antrum elevator
 Elévateur pour le fosse nasale
Elevador para el antro
 Elevatore per antro



HALLE

160 mm - 6 1/4"	tk 51617-16
-----------------	--------------------

Septum elevator - Raspatories
Septum elevators - raspatories

Elevateurs - rugines pour la cloison nasale
Elevadores - legras para el tabique nasal
 Elevatori - periostotomi per setto

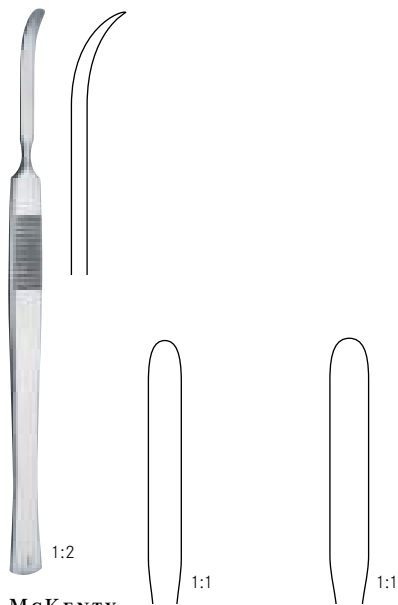

MCKENTY

	4 mm	5 mm
150 mm - 6"	tk 51619-04	tk 51619-05

scharf
 sharp
 tranchant
 cortante
 acuta



COTTLE

	x = 5 mm
235 mm - 9 1/4"	tk 51620-23

scharf
 sharp
 tranchant
 cortante
 acuta



MCKENTY

	x = 4 mm
205 mm - 8"	tk 51621-22

scharf
 sharp
 tranchant
 cortante
 acuta

Septumlevatorien - Raspatorien
Septum elevators - raspatories

Elevateurs - rugines pour la cloison nasale
Elevadores - legras para el tabique nasal
 Elevatori - periostotomi per setto



KILLIAN

x = 4 mm

180 mm - 7" **tk 51622-18**

scharf/stumpf
sharp/blunt
 tranchant/mousse
cortante/romo
 acuta/smussa

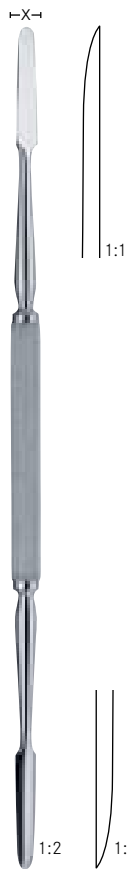

KILLIAN

x = 4.5 mm

230 mm - 9" **tk 51623-22**

scharf/stumpf
sharp/blunt
 tranchant/mousse
cortante/romo
 acuta/smussa



FREER

190 mm - 7 1/2"

tk 51625-19

stumpf
blunt
 mousse
romo
 smussa



FREER

180 mm - 7"

tk 51627-18

scharf/stumpf
sharp/blunt
 tranchant/mousse
cortante/romo
 acuta/smussa

Septumlevatorien – Raspatorien
Septum elevators – raspatories

Elevateurs – rugines pour la cloison nasale
Elevadores – legras para el tabique nasal
Elevatori – periostotomi per setto



FREER

205 mm – 8 " **tk 51631-20**

scharf/stumpf
sharp/blunt
tranchant/mousse
cortante/romo
acuta/smussa



PENNINGTON

215 mm – 8½ " **tk 51629-21**

stumpf
blunt
mousse
romo
smussa



JOSEPH-MASING

215 mm – 8½ " **tk 51634-22**

scharf
sharp
tranchant
cortante
acuta

Periostelevatorien
Periosteal elevators

Elevateurs pour la périoste
Legras para periostio
Elevatori per il periosto



MASING

200 mm - 8"	tk 51636-21
-------------	--------------------

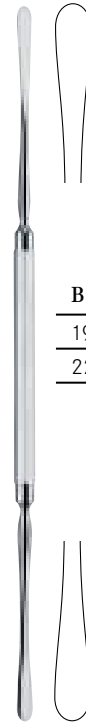

BALLENGER-HAJEK

190 mm - 7 1/4"	tk 51637-19
220 mm - 8 3/4"	tk 51637-22

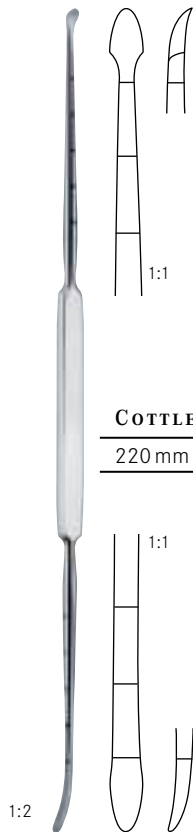

COTTLE

220 mm - 8 3/4"	tk 51643-22
-----------------	--------------------

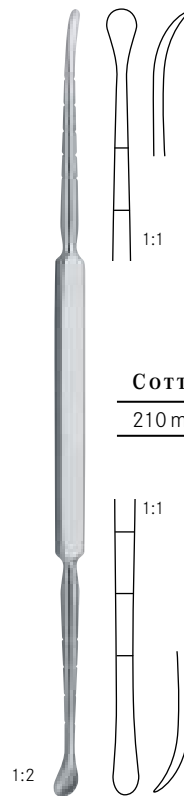

COTTLE

210 mm - 8 1/4"	tk 51644-21
-----------------	--------------------

Septumelevatorien
Septum elevators

Elevateurs pour la cloison nasale
Elevadores para el tabique nasal
Elevatori per setto



BOIES

190 mm - 7½" **tk 51650-18**

Nasenfraktur Elevatorium, stumpf
Nasal fracture elevator, blunt

Elévateur pour fractures nasales, mousse
Elevador para fracturas nasales, romas
Elevatore per fratture nasalì, smussa

1:2



GOLDMAN

170 mm - 6¾" **tk 51651-17**

Septumfraktur Elevatorium
Septum displacer

Elévateur pour fractures de la cloison nasale
Elevador para fracturas del tabique nasal
Elevatore per fratture del setto

1:2

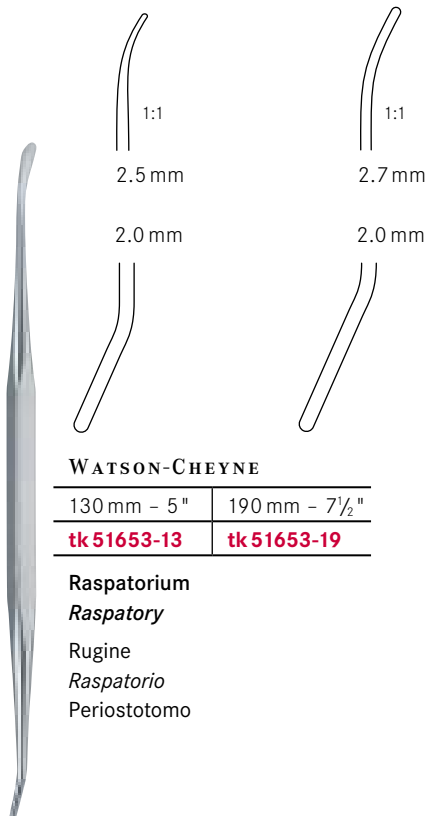

WATSON-CHEYNE

130 mm - 5"	190 mm - 7½"
tk 51653-13	tk 51653-19

Raspatorium
Raspatory

Rugine
Raspatorio
Periostotomo



tk 51642-20
195 mm - 8¾"
Ø 2.3 / 2.6 mm

1:2

Nasensägen | Scies nasales
Nasal saws | *Sierras nasales*
 Seghe nasali



1:2



1:2

JOSEPH

190 mm - 7½"	190 mm - 7½"
tk 51661-01	tk 51661-02



1:2

JOSEPH

190 mm - 7½"
tk 51661-03



1:2

1:2

JOSEPH

170 mm - 6¾"	170 mm - 6¾"
tk 51655-20	tk 51657-20

Nasenraspeln | Râpes nasales
Nasal rasps | Limas nasales
Raspe nasali

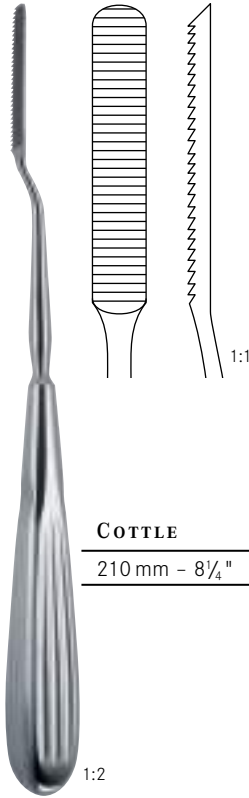

COTTLE

210 mm - 8 1/4"	tk 51665-21
-----------------	--------------------

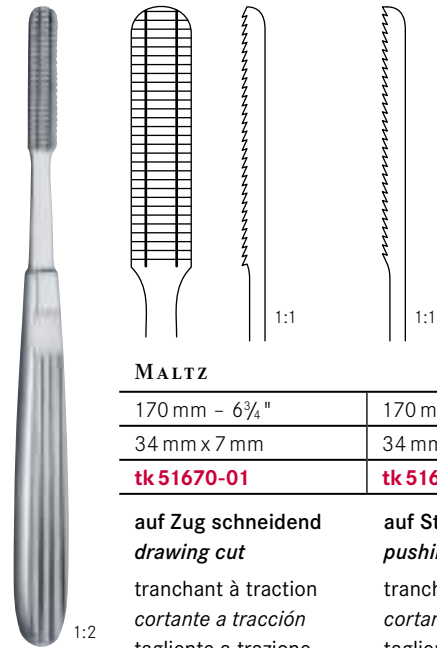

MALTZ

170 mm - 6 3/4"	170 mm - 6 3/4"
34 mm x 7 mm	34 mm x 7 mm
tk 51670-01	tk 51670-02

auf Zug schneidend
drawing cut
tranchant à traction
cortante a tracción
tagliente a trazione

auf Stoss schneidend
pushing cut
tranchant à impact
cortante a empuje
tagliente a urto

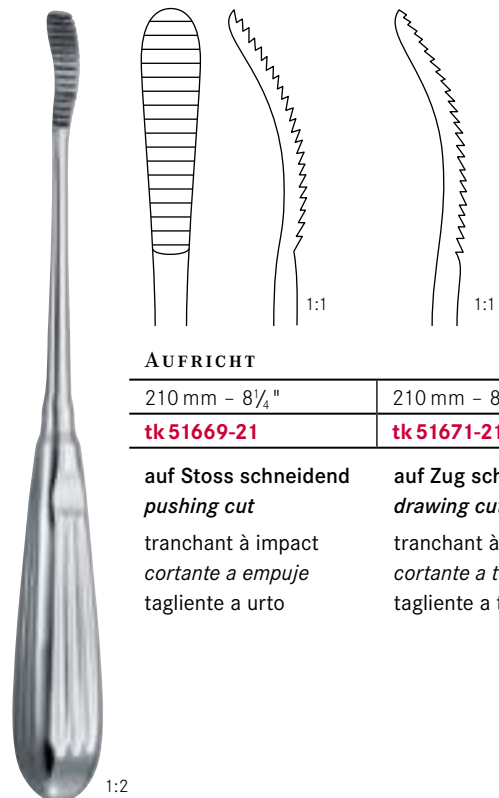

AUFRICHT

210 mm - 8 1/4"	210 mm - 8 1/4"
tk 51669-21	tk 51671-21

auf Stoss schneidend
pushing cut
tranchant à impact
cortante a empuje
tagliente a urto

auf Zug schneidend
drawing cut
tranchant à traction
cortante a tracción
tagliente a trazione

Nasenraspeln | Râpes nasales
Nasal rasps | *Limas nasales*
 Raspe nasali

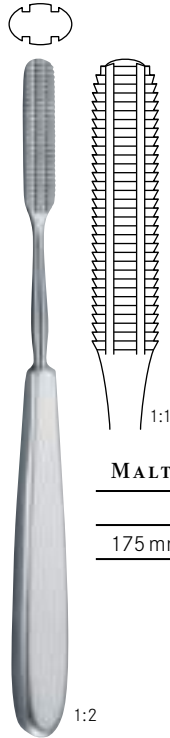

MALTZ

	40 mm x 9 mm
175 mm - 7"	tk 51663-18



WIENER

	Ø 3.5 mm	Ø 3.5 mm
180 mm - 7"	tk 51675-18	tk 51677-18

Antrum Raspeln
Antrum rasps

Râpes pour le fosse nasale
Limas para el antrum
 Raspe per antrum

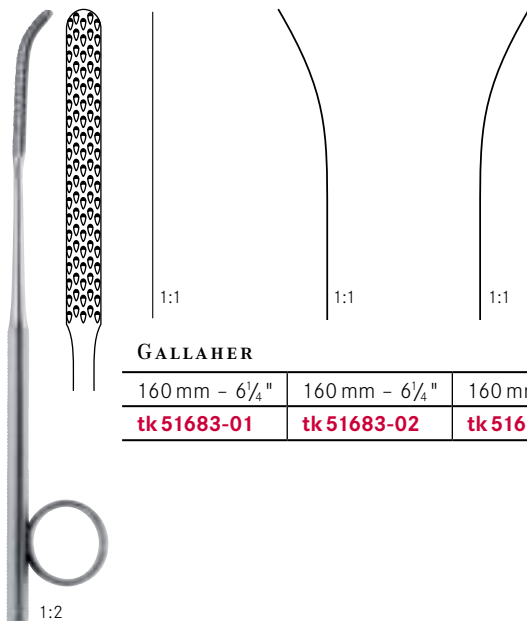

GALLAHER

160 mm - 6¼"	160 mm - 6¼"	160 mm - 6¼"
tk 51683-01	tk 51683-02	tk 51683-03

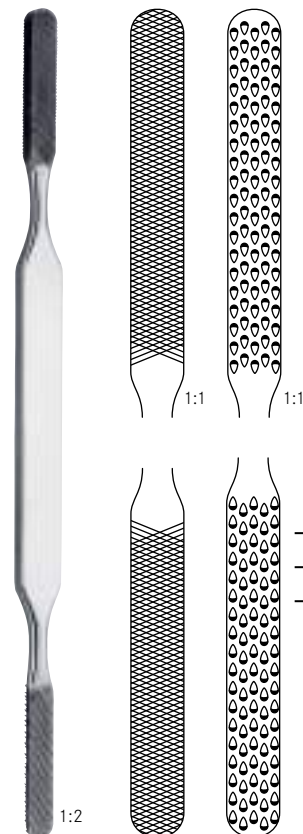

FOMON

210 mm - 8¼"
tk 51685-21

Raspeln mit Hartmetall
Rasps with tungsten carbide

Râpes avec inserts de carbure de tungstène
Limas con carburo de tungsteno
Raspe con tungsteno

TUCAR^{TK}

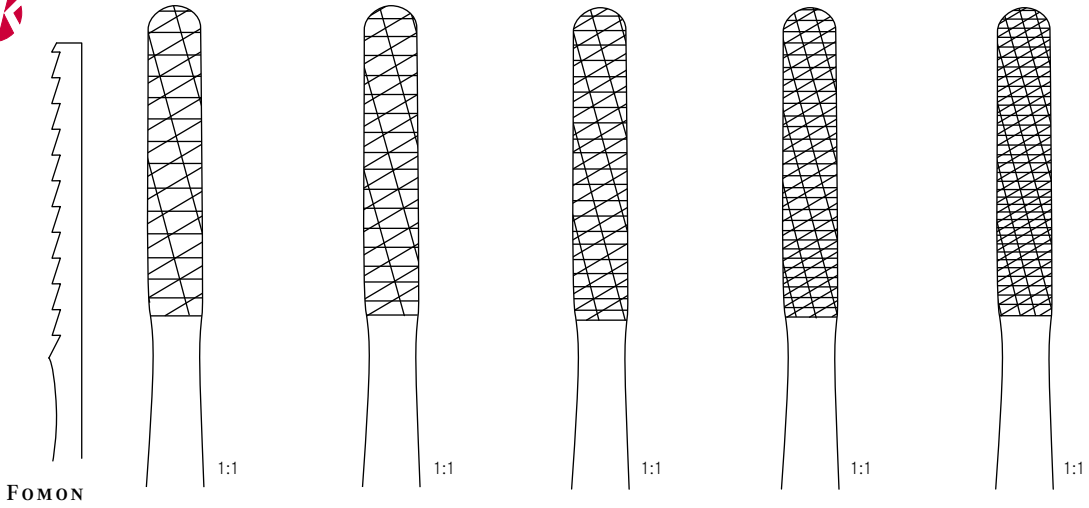
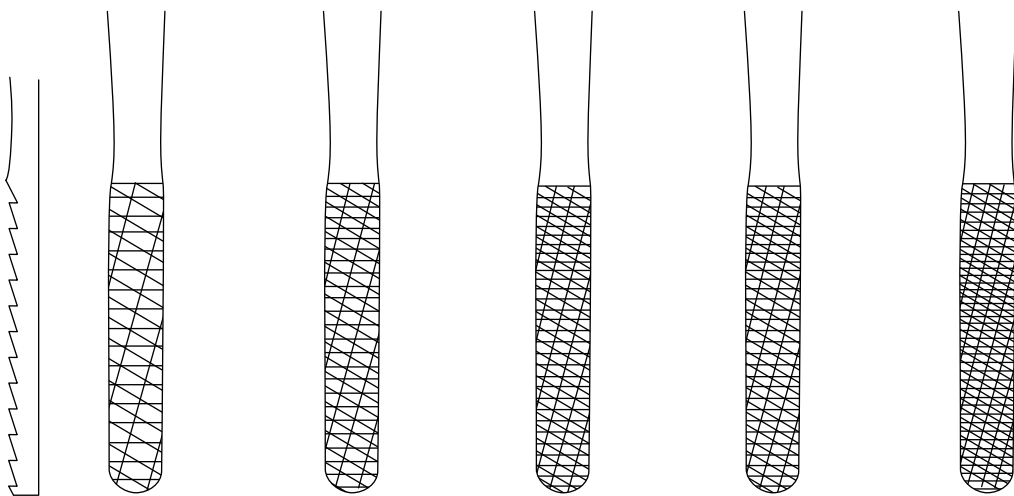

	Fig. 1	Fig. 3	Fig. 5	Fig. 7	Fig. 9
	12	16	24	36	52

Zähne
Teeth
Dentes
Dientes
Denti

200 mm - 8"	tk 51686-01 tucar	tk 51686-03 tucar	tk 51686-05 tucar	tk 51686-07 tucar	tk 51686-09 tucar
-------------	-------------------	-------------------	-------------------	-------------------	-------------------



FOMON TC

	Fig. 2	Fig. 4	Fig. 6	Fig. 8	Fig. 10
	14	20	30	44	62

Zähne
Teeth
Dentes
Dientes
Denti

1:1

Raspeln mit Hartmetall
Rasps with tungsten carbide

Râpes avec inserts de carbure de tungstène
Limas con carburo de tungsteno
Raspe con tungsteno

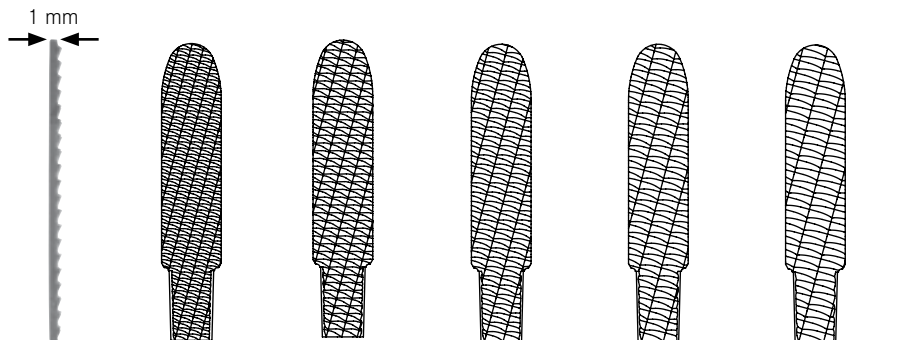

Fig. 1	Fig. 2	Fig. 3	Fig. 4	Fig. 5
tk 51687-01	tk 51687-02	tk 51687-03	tk 51687-04	tk 51687-05

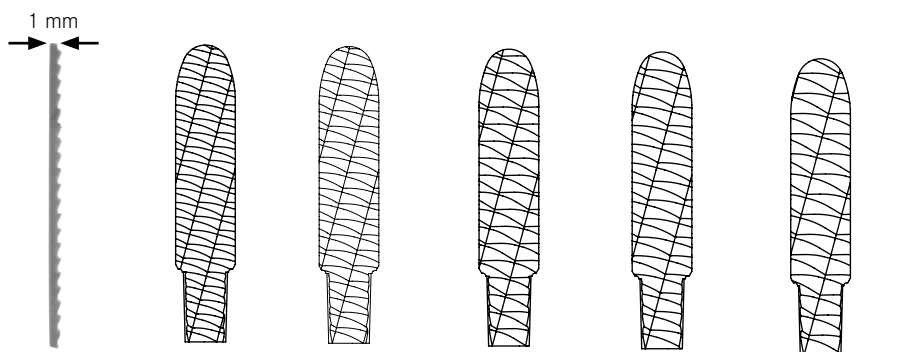
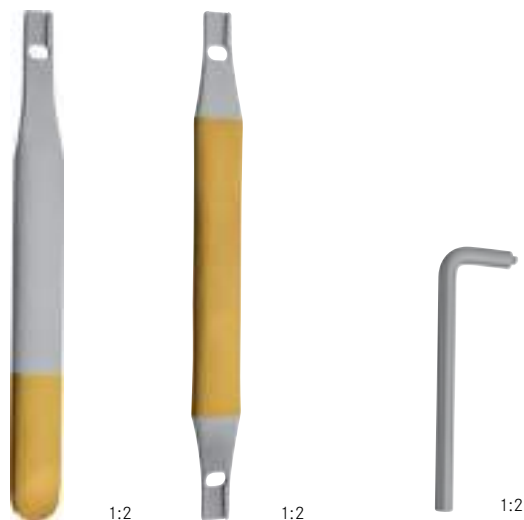

Fig. 6	Fig. 7	Fig. 8	Fig. 9	Fig. 10
tk 51687-06	tk 51687-07	tk 51687-08	tk 51687-09	tk 51687-10



auswechselbar
interchangeable
interchangeables
intercambiables
intercambiabili



135 mm - 5"	tk 51687-15	tk 51687-16
-------------	--------------------	--------------------

70 mm - 2¾"	tk 51687-19
-------------	--------------------

Septuminstrumente
Septum instruments

Instruments pour la cloison nasal
Instrumentos para el tabique nasal
Strumenti per il setto nasale



1:2

BRUENINGS-BRUNK

190 mm - 7½" tk 16955-19

Kieferhöhlenhaken, gezahnt
Antrum retractor, serrated

Ecarteur pour sinus maxillaire, dentelé
Separador para sinus, dentado
Retrattore mascellare, dentato



1:2

RITTER-HALLE

	160 mm - 6¼"
2.5 mm Ø	tk 6376-25
3.0 mm Ø	tk 6376-30
4.0 mm Ø	tk 6376-40

Stirnhöhlen-Dilatatoren
Frontal sinus bougies

Dilatateurs pour le sinus frontal
Dilatadores para el sinus frontal
Dilatatore per il seno frontale

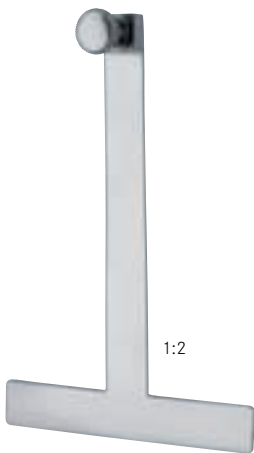

1:2

COTTLE

120 mm - 4¾" tk 51647-01

Griff
Handle
Manche
Mango
Manico



1:2

COTTLE

7 mm tk 51647-02

Führungshilfe für Osteotome
Guide support for osteotomes
Support conducteur pour ostéotomes
Soporte de guía para osteótomos
Supporto di guida per osteotomi

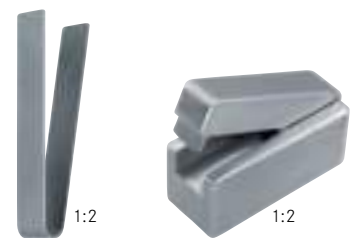

1:2

1:2

COTTLE

65 mm x 30 mm x 30 mm tk 51648-00

Knorpelquetsche
Cartilage crusher
Pincas-gouge à cartilage
Machacadora
Torchio per cartilagine

Septumzangen
Septum forceps

Pinces pour la cloison nasale
Pinzas para el tabique nasal
Pinze per il setto nasale

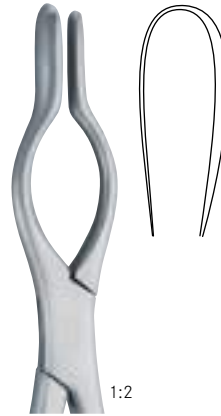

COTTLE-WALSHAM

230 mm - 9"	tk 51695-01	tk 51695-02	tk 51695-03
gerade <i>straight</i> droit <i>recta</i> rette		links <i>left</i> à gauche <i>izquierda</i> a sinistra	rechts <i>right</i> à droite <i>derecha</i> a destra

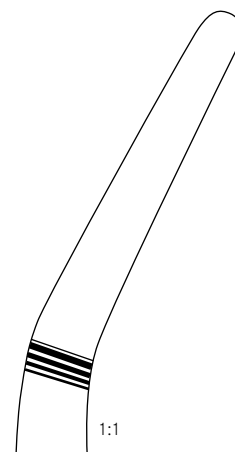

ASCH

230 mm - 9"	tk 51697-23
-------------	--------------------

Septumzangen
Septum forceps

Pinces pour la cloison nasale
Pinzas para el tabique nasal
Pinze per il setto nasale



MIDDLETON-JANSEN

190 mm - 7½" **tk 51180-19**

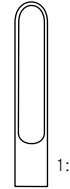

MIDDLETON-JANSEN

190 mm - 7½" **tk 51182-19**

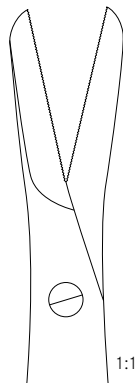

CAPLAN

200 mm - 8" **tk 51184-20**

gezahnt
toothed
dentelée
dentado
dentato

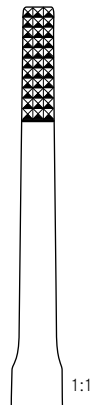

RUBIN

210 mm - 8¼" **tk 51188-21**

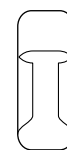

tk 51188-01

Schutzkappe
Protection Cap

Capuchon protecteur
Caperuza protectora
Calotta protettiva

Ringmesser
Adenoid curettes

Couteaux à végétations adénoïdes
Cuchillos para vegetaciones adenoides
Adenotomi



1:2

ST. CLAIR-THOMSON

210 mm - 8 1/4"

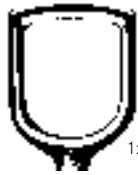

1:1



1:1



1:1

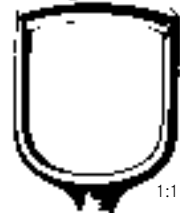

1:1

tk 51405-01	tk 51405-02	tk 51405-03	tk 51405-04
--------------------	--------------------	--------------------	--------------------



1:2

BARNHILL

220 mm - 8 3/4"

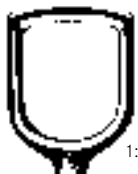

1:1



1:1



1:1

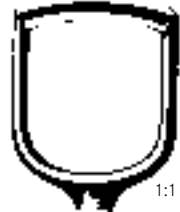

1:1

Fig. 1	Fig. 2	Fig. 3	Fig. 4
tk 51415-01	tk 51415-02	tk 51415-03	tk 51415-04

Ringmesser
Adenoid curettes

Couteaux à végétations adénoïdes
Cuchillos para vegetaciones adenoides
Adenotomi



BECKMANN

220 mm - 8 $\frac{3}{4}$ "

tk 51412-01

tk 51412-02

tk 51412-03

gerade
straight

droit
recto
rette

220 mm - 8 $\frac{3}{4}$ "

tk 51413-01

tk 51413-02

tk 51413-03

gebogen
curved

courbe
curvo
curve



220 mm - 8 $\frac{3}{4}$ "

tk 51412-04

tk 51412-05

tk 51412-06

gerade
straight

droit
recto
rette

220 mm - 8 $\frac{3}{4}$ "

tk 51413-04

tk 51413-05

tk 51413-06

gebogen
curved

courbe
curvo
curve

Ringmesser
Adenoid curettes

Couteaux à végétations adénoïdes
Cuchillos para vegetaciones adenoides
Adenotomi



1:2

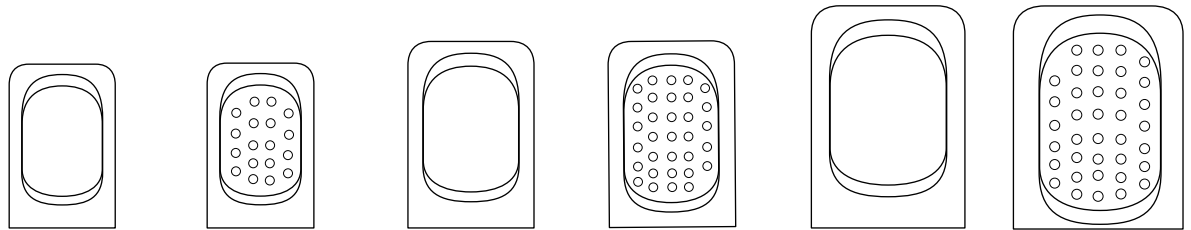

LA FORCE

Fig. 1		Fig. 2		Fig. 3	
250 mm - 7"		250 mm - 7"		250 mm - 7"	
tk 51511-01	tk 51513-01	tk 51511-02	tk 51513-02	tk 51511-03	tk 51513-03
250 mm - 9 3/4"		250 mm - 9 3/4"		250 mm - 9 3/4"	

tk 51521-01	tk 51522-01	tk 51521-02	tk 51522-02	tk 51521-03	tk 51522-03
--------------------	--------------------	--------------------	--------------------	--------------------	--------------------

Ersatzklingen
Spare blades

Lames de rechange
Hojas de cambio
Lame di ricambio

Ringmesser
Adenoid curettes

Couteaux à végétations adénoïdes
Cuchillos para vegetaciones adenoides
Adenotomi



BALLENGER

	200 mm - 8"	200 mm - 8"
x = 3 mm	tk 51410-03	tk 51411-03
x = 4 mm	tk 51410-04	tk 51411-04
x = 5 mm	tk 51410-05	tk 51411-05

gerade
straight

droit
recto
rette

bajonett
bayonet

baionette
bayoneta
baionetta

Pulverbläser
Atomizers
Pulvérisateurs
Pulverizadores
Insoffiatori



KABIERSCHE

tk 50920-00	tk 50920-01	tk 50920-50
Pulverbläser, komplett <i>Atomizer, complete</i>	Ersatzflasche, 30 ccm <i>Spare bottle, 30 ccm</i>	Ventilball <i>Valve rubber bulb</i>
Pulvérisateur, complet <i>Pulverizador, completo</i>	Flacon de recharge, 30 ccm <i>Frasco suelto, 30 ccm</i>	Poire en caoutchouc avec valve <i>Pera de goma con valva</i>
Insoffiatore, completo	Bottiglia di ricambio, 30 ccm	Pallone in gomma con valva

KABIERSCHE

80 mm - 3 1/4"	tk 50920-08	
110 mm - 4 1/4"	tk 50920-11	
130 mm - 5"		tk 50920-13

Kanüle gerade <i>Cannula, straight</i>	Kanüle gebogen <i>Cannula curved</i>
Canule droit <i>Cánula recta</i>	Canule courbe <i>Cánula curva</i>
Cannula retta	Cannula curva



UNIVERSAL

tk 50924-00
Pulverbläser, komplett mit beweglicher Düse, Flasche 30 ccm <i>Atomizer, complete with movable tube, bottle 30 ccm</i>
Pulvérisateur, complet avec tuyère mobile, flacon 30 ccm <i>Pulverizador, completo con tubo móvil, botella 30 ccm</i>
Insoffiatore, completo con ugello mobile, bottiglia 30 ccm

Luftdusche
Air Bag

Douche à air
Insuflador aire
Insuffiadori d'aria



POLITZER

tk 50930-00

komplett mit 3 Nasenoliven
complete with 3 nasal olives

complet avec 3 olives nasales
completo con 3 olivas nasales
completo con 3 olive nasali



15 mm Ø

tk 50930-15

Nasenoliven
Nasal olives

Olives nasales
Olivas nasales
Olive nasali



17 mm Ø

tk 50930-17



22 mm Ø

tk 50930-22



4 mm Ø

tk 50930-04

Ohrolive
Ear olive

Olive auriculaire
Oliva auricular
Oliva auricolare

tk 50930-50

Gummibirne mit Einsteckkonus
Rubber bulb with connecting nozzle

Poire en caoutchouc avec embout de raccordement
Pera de goma con cono de conexión
Pera in gomma con cono di connessione

Mundsperrer | Ouvre-bouches
 Mouth gags | Abrebocas
 Apribocca

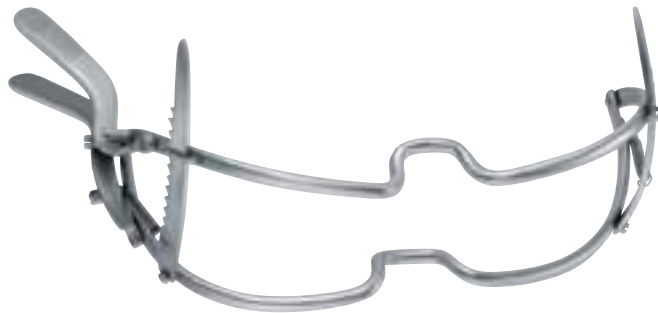

WHITEHEAD	
110 mm - 4 1/4"	tk 52031-11
130 mm - 5"	tk 52031-13
150 mm - 6"	tk 52031-15



JENNINGS	
90 mm - 3 1/2"	tk 52041-09
110 mm - 4 1/4"	tk 52041-11
130 mm - 5"	tk 52041-13
150 mm - 6"	tk 52041-15



MAUNDER	
	4 mm Ø
100 mm - 4"	tk 52300-00

Holz
 Wood
 Bois
 Madera
 Legno

1:2



HEISTER	
130 mm - 5"	tk 52110-13

1:2

Mundsperrer | Ouvre-bouches
 Mouth gags | Abrebocas
 | Apribocca



MOLT
 110 mm - 4 $\frac{3}{4}$ " | **tk 52131-11**

Für Kinder
For children
 Pour enfants
 Para niños
 Per bambini

1:2



MOLT
 140 mm - 5 $\frac{1}{2}$ " | **tk 52131-14**

Für Erwachsene
For adults
 Pour adultes
 Para adultos
 Per adulti

1:2



DENHART
 120 mm - 4 $\frac{3}{4}$ " | **tk 52141-12**



FERGUSON-ACKLAND
 145 mm - 5 $\frac{3}{4}$ " | **tk 52142-14**



ROSER-KÖNIG
 160 mm - 6 $\frac{1}{4}$ " | **tk 52149-16**
 190 mm - 7 $\frac{1}{2}$ " | **tk 52149-19**

Mundsperrer | Ouvre-bouches
Mouth gags | Abrebocas
 Apribocca



DINGMANN

145 mm - 5 3/4" **tk 52240-00**

Komplett mit Rahmen, 3 Zungenspateln und 2 beweglichen Seitenvalven
Complete with frame, 3 tongue depressors and 2 adjustable lateral blades

Complet avec cadre, 3 abaisse-langues et 2 valves latérales réglables

Completo con bastidor, 3 bajalenguas y 2 valvas laterales ajustables

Completo con telaio, 3 abassalingua e 2 valve laterali movibili



55 x 25 mm

tk 52240-01



60 x 27 mm

tk 52240-02



70 x 30 mm

tk 52240-03

Mundsperrer | Ouvre-bouches
Mouth gags | Abrebocas
Apribocca



KILNER-DOUGHTY

	Fig. 1	Fig. 2	Fig. 3	
	28 mm x 65 mm	32 mm x 75 mm	37 mm x 80 mm	
	tk 52250-01	tk 52250-02	tk 52250-03	tk 52250-10

Griff
Handle
Manche
Mango
Manico

tk 52250-00	x	x	x	x
--------------------	---	---	---	---

komplett
complete
complet
completa
completa

Mundsperrer | Ouvre-bouches
 Mouth gags | Abrebocas
 | Apribocca



NEGUS

Griff
 Handle
 Manche
 Mango
 Manico

tk 52260-00	x	x	x	x
--------------------	---	---	---	---

komplett
 complete
 complet
 completa
 completa

Mundsperrer | Ouvre-bouches
 Mouth gags | Abrebocas
 | Apribocca



DAVIS-BOYLE

	Fig. 1	Fig. 2	Fig. 3	Fig. 4	Fig. 5	
	tk 52270-01	tk 52270-02	tk 52270-03	tk 52270-04	tk 52270-05	tk 52270-10
	21 mm x 30 mm	23 mm x 65 mm	24 mm x 80 mm	25 mm x 93 mm	26 mm x 108 mm	

Griff, fest
 Handle, rigid
 Manche, rigide
 Mango, rigida
 Manico, rigido

tk 52270-00	x	x	x	x	x	x
--------------------	---	---	---	---	---	---

komplett, für Erwachsene
complete, for adults
 complet, pour adultes
 completa, para adultas
 completa, per adulti

DAVIS-BOYLE

	Fig. 1	Fig. 2	Fig. 3	Fig. 4	Fig. 5	
	tk 52274-01	tk 52274-02	tk 52274-03	tk 52274-04	tk 52274-05	tk 52274-00
	17 mm x 26 mm	19 mm x 46 mm	20 mm x 58 mm	22 mm x 71 mm	22 mm x 80 mm	

Griff, fest
 Handle, rigid
 Manche, rigide
 Mango, rigida
 Manico, rigido

tk 52274-10	x	x	x	x	x	x
--------------------	---	---	---	---	---	---

komplett, für Kinder
complete, for children
 complet, pour enfants
 completa, niños
 completa, per bambini

Mundsperrer
Mouth gags
Ouvre-bouches
Abrebocas
Apribocca



DAVIS-BOYLE

	Fig. 1	Fig. 2	Fig. 3	Fig. 4	Fig. 5	
	tk 52275-01	tk 52275-02	tk 52275-03	tk 52275-04	tk 52275-05	tk 52275-10
	21 mm x 26 mm	23 mm x 65 mm	24 mm x 80 mm	25 mm x 93 mm	26 mm x 108 mm	

Griff, beweglich
Handle, movable
Manche, mobile
Mango, movil
Manico, girevole

tk 52275-00	x	x	x	x	x	x
--------------------	---	---	---	---	---	---

komplett, für Erwachsene
complete, for adults
complet, pour adultes
completa, para adultas
completa, per adulti

DAVIS-BOYLE

	Fig. 1	Fig. 2	Fig. 3	Fig. 4	Fig. 5	
	tk 52276-01	tk 52276-02	tk 52276-03	tk 52276-04	tk 52276-05	tk 52275-10
	17 mm x 26 mm	19 mm x 46 mm	20 mm x 58 mm	22 mm x 71 mm	22 mm x 80 mm	

Griff, beweglich
Handle, movable
Manche, mobile
Mango, movil
Manico, girevole

tk 52276-00	x	x	x	x	x	x
--------------------	---	---	---	---	---	---

komplett, für Kinder
complete, for children
complet, pour enfants
completa, niños
completa, per bambini

Mundsperrer | Ouvre-bouches
Mouth gags | Abrebocas
Apribocca

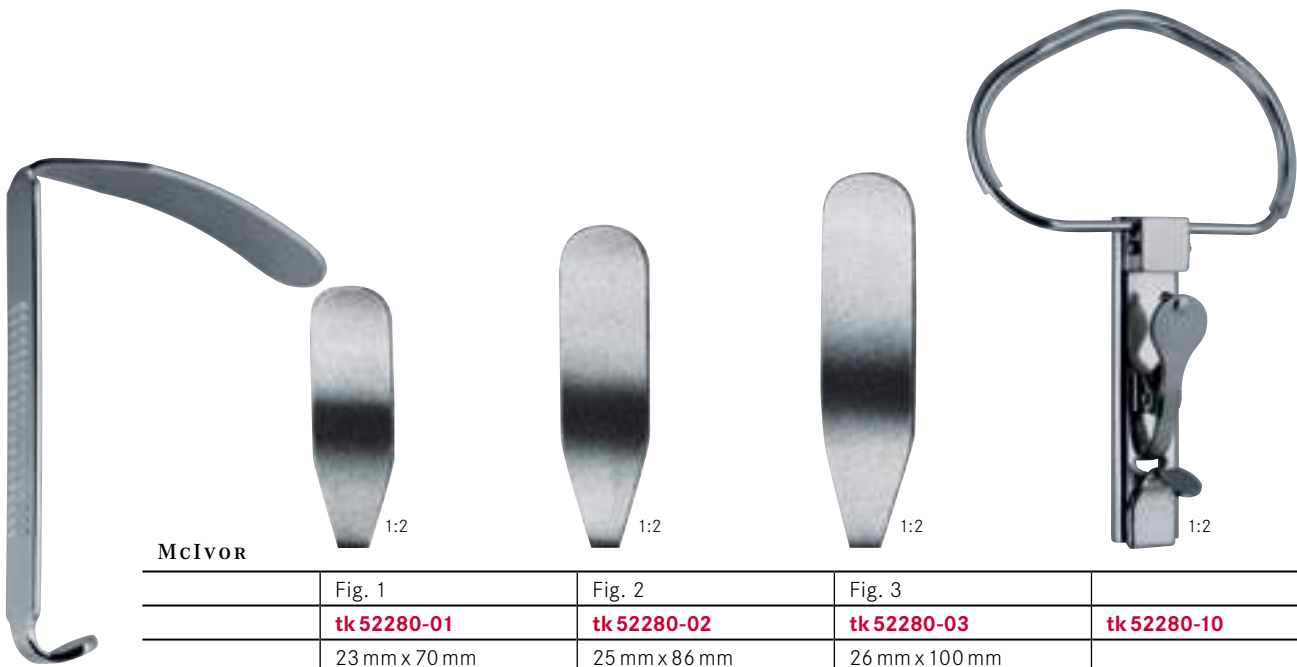

McIVOR

	Fig. 1	Fig. 2	Fig. 3	
	tk 52280-01	tk 52280-02	tk 52280-03	tk 52280-10
	23 mm x 70 mm	25 mm x 86 mm	26 mm x 100 mm	

Griff
Handle
Manche
Mango
Manico

tk 52280-00	x	x	x	x
--------------------	---	---	---	---

komplett
complete
complet
completa
completa

Kehlkopfspiegel | Miroirs laryngiens
Laryngeal mirrors | *Especjos laringeos*
 Specchi laringei

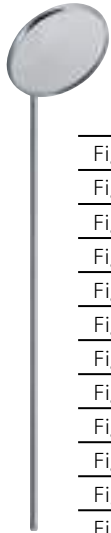

Fig. 00	8 mm Ø	tk 53515-08
Fig. 0	10 mm Ø	tk 53515-10
Fig. 1	12 mm Ø	tk 53515-12
Fig. 2	14 mm Ø	tk 53515-14
Fig. 3	16 mm Ø	tk 53515-16
Fig. 4	18 mm Ø	tk 53515-18
Fig. 5	20 mm Ø	tk 53515-20
Fig. 6	22 mm Ø	tk 53515-22
Fig. 7	24 mm Ø	tk 53515-24
Fig. 8	26 mm Ø	tk 53515-26
Fig. 9	28 mm Ø	tk 53515-28
Fig. 10	30 mm Ø	tk 53515-30



100 mm - 4"
tk 53504-10

1:2

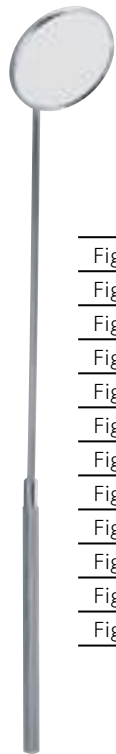

Fig. 00	8 mm Ø	tk 53525-08
Fig. 0	10 mm Ø	tk 53525-10
Fig. 1	12 mm Ø	tk 53525-12
Fig. 2	14 mm Ø	tk 53525-14
Fig. 3	16 mm Ø	tk 53525-16
Fig. 4	18 mm Ø	tk 53525-18
Fig. 5	20 mm Ø	tk 53525-20
Fig. 6	22 mm Ø	tk 53525-22
Fig. 7	24 mm Ø	tk 53525-24
Fig. 8	26 mm Ø	tk 53525-26
Fig. 9	28 mm Ø	tk 53525-28
Fig. 10	30 mm Ø	tk 53525-30



MICHEL

	250 mm - 9¾"
12 mm Ø	tk 53541-12
14 mm Ø	tk 53541-14
16 mm Ø	tk 53541-16
18 mm Ø	tk 53541-18

Spiegel beweglich
moveable mirror

miroir mobile
esepejo movable
 specchio mobile

Kehlkopfinstrumente
Laryngeal instruments

Instruments laryngiens
Instrumentos laringeos
Strumenti laringei



REICHERT

230 mm - 9"

tk 52598-24

1:2

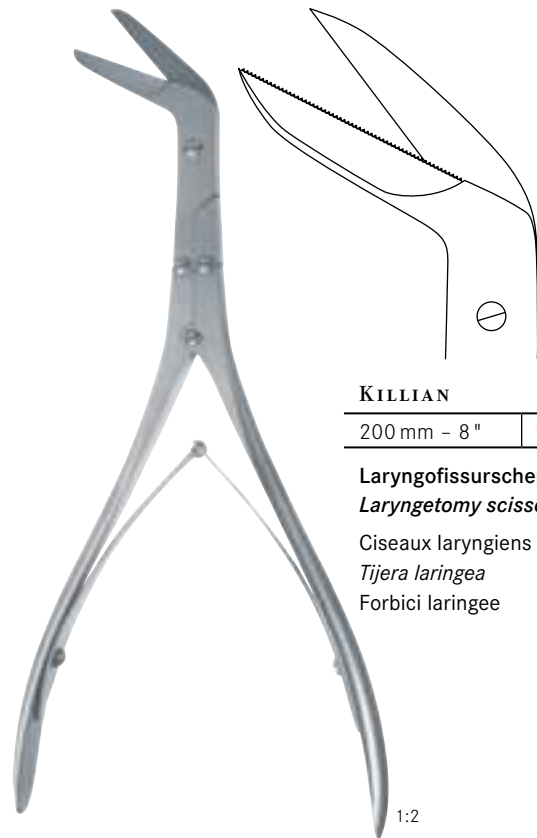

KILLIAN

200 mm - 8"

tk 53550-20

Laryngofissurschere
Laryngotomy scissors

Ciseaux laryngiens

Tijera laringea

Forbici laringee

1:2

Tonsillenschnürer | Serre noeuds pour amygdales
Tonsil snares | *Cierra-nudos para amigdales*
 Serranodi per tonsille

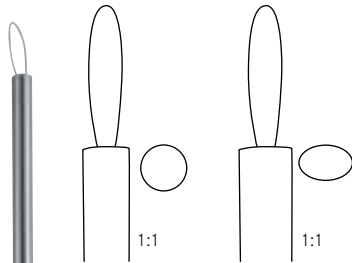

EVES

280 mm - 11 "	280 mm - 11 "
tk 50336-28	tk 50338-28

Für offene Schlingen
for open loops
 pour anses ouvertes
para asas abiertas
 per anse aperte

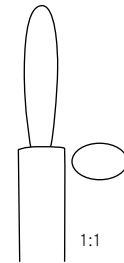

EVES

280 mm - 11 "
tk 50340-28

Für offene Schlingen
for open loops
 pour anses ouvertes
para asas abiertas
 per anse aperte

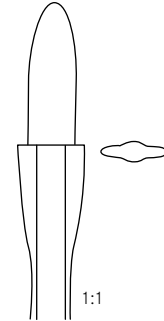

BRUENINGS

280 mm - 11 "
tk 50342-28

Für geschlossene Schlingen
for soldered loops
 pour anses soudées
para asas cerradas
 per anse saldate

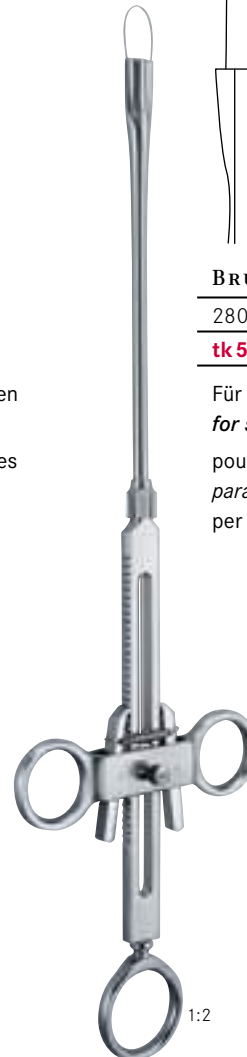

0.4 mm Ø, 40 mm	tk 50345-40
0.4 mm Ø, 50 mm	tk 50345-50

Packung mit 100 Stück
package of 100 pieces
 paquet de 100 pièces
paquete de 100 piezas
 pacchetto da 100 pezzi



0.4 mm Ø x 10 cm	tk 50347-01
------------------	--------------------

Packung mit 12 Stück
package of 12 pieces
 paquet de 12 pièces
paquete de 12 piezas
 pacchetto da 12 pezzi

Tonsillenschnürer
Tonsil snares

Serre noeuds pour amygdales
Cierra-nudos para amigdales
Serranodi per tonsille

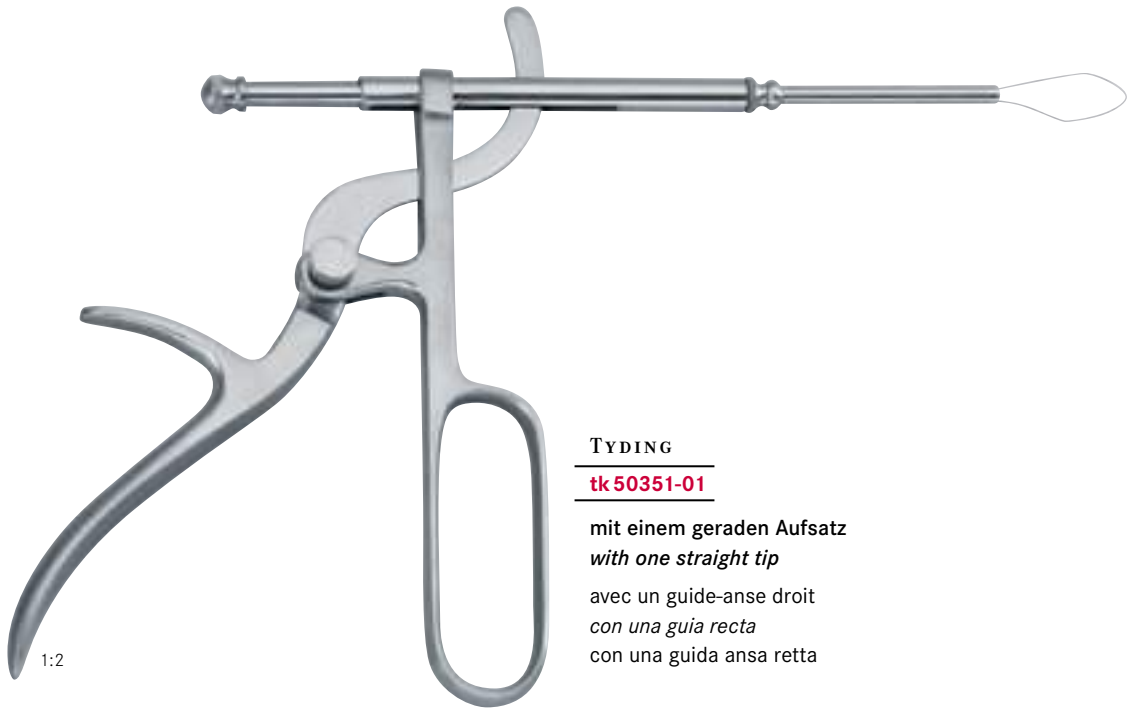

TYDING

tk 50351-01

mit einem geraden Aufsatz
with one straight tip

avec un guide-anse droit
con una guida recta
con una guida ansa retta



0.4 mm Ø x 10 cm

tk 50347-02

Packung mit 100 Stück
package of 100 pieces

paquet de 100 pièces
paquete de 100 piezas
pacchetto da 100 pezzi

Tonsillieninstrumente
Tonsil instruments

Instruments pour amygdales
Instrumentos para amígdalas
Strumenti per tonsille



CARPENTER

250 mm - 9³/₄" tk 52607-25

Enukleator
Enucleator

Enucléateur pour amygdales
Enucleador para amígdalas
Enucleatore

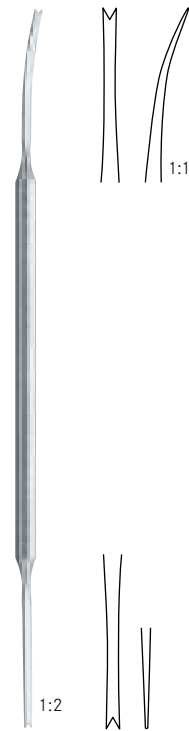

LUNIATSCHEK

180 mm - 7" tk 52610-19

Tonsillen-Tamponstopfer
Tonsil tampon plugger

Porta coton
Porta algodones
Porta tamponi

Tonsilleninstrumente
Tonsil instruments

Instrumentos para amigdales
Instrumentos para amigdalas
Strumenti per tonsille

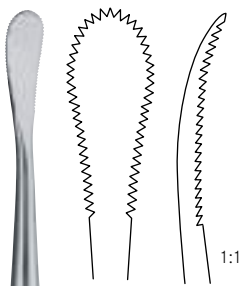

1:1

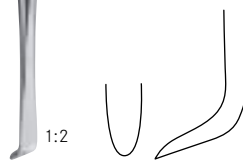

1:2

HENKE

230 mm - 9"

tk 52601-23

Tonsillendisektor
Tonsil dissector

Dissecteur à amygdales
Disector para amigdalas
Dissettore tonsillare

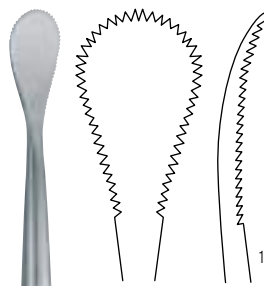

1:1



1:2

HENKE

230 mm - 9"

tk 52603-23

Tonsillendisektor
Tonsil dissector

Dissecteur à amygdales
Disector para amigdalas
Dissettore tonsillare



1:2

HURD

225 mm - 8¾"

tk 52605-22

Tonsillendisektor
Tonsil dissector

Dissecteur à amygdales
Disector para amigdalas
Dissettore tonsillare

Tonsillieninstrumente
Tonsil instruments

Instrumentos para amigdales
Instrumentos para amigdales
Strumenti per tonsille



LEWIS

195 mm - 7³/₄" **tk 52612-20**

Tonsillenschraube
Tonsil screw

Tire amygdales
Tira amigdales
Fissa tonsille

1:2



1:1

MARSCHIK

220 mm - 8³/₄" **tk 52622-22**

Tonsillen-Fassspinzette
Tonsil seizing forceps

Pince pour saisir les amygdales
Pinza prensora de amigdales
Pinza da presa tonsille

1:2



1:1

BLOHMKE

200 mm - 8" **tk 52627-20**

1:2

Tonsillieninstrumente
Tonsil instruments

Instruments pour amygdales
Instrumentos para amigdalas
Strumenti per tonsille

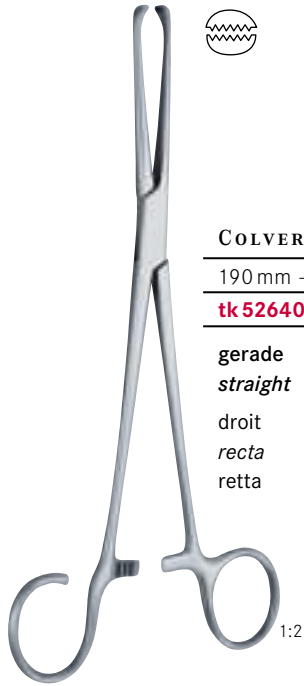

COLVER

190 mm - 7½"	190 mm - 7½"
tk 52640-18	tk 52641-18

gerade
straight

droit
recta
retta

gebogen
curved

courbe
curva
curva

1:2

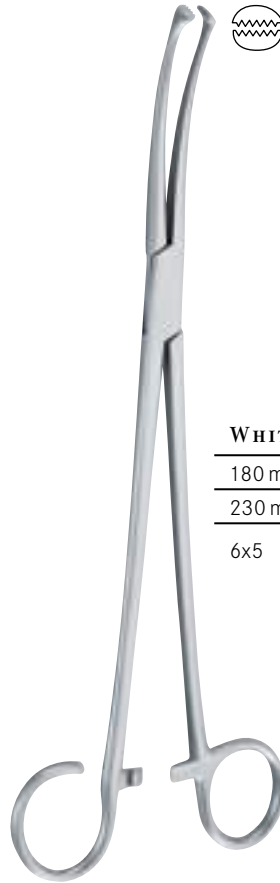

WHITE

180 mm - 7"	tk 52659-18
230 mm - 9"	tk 52659-23

6x5

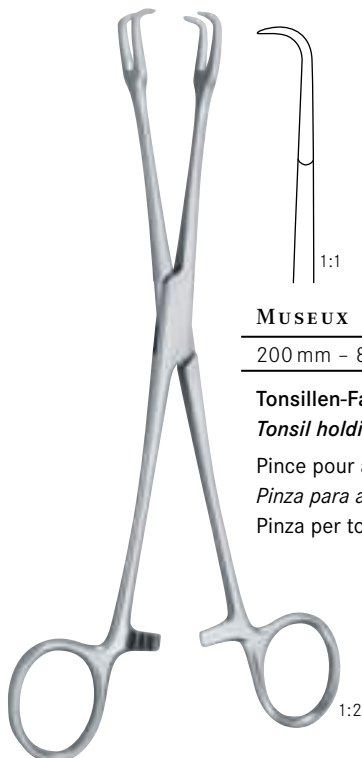

MUSEUX

200 mm - 8"	tk 52664-20
-------------	--------------------

Tonsillen-Fasszange
Tonsil holding forceps

Pince pour amygdales
Pinza para amigdalas
Pinza per tonsille

1:2



JACKSON

220 mm - 8¾"	tk 52594-22
--------------	--------------------

Kehlkopfpinzette
Laryngeal forceps

Pince laryngienne
Pinza laringea
Pinza laringea

1:2

Tonsillotome | Amygdalatomes
 Tonsillectomes | Amigdalótomos
 Tonsillotomi

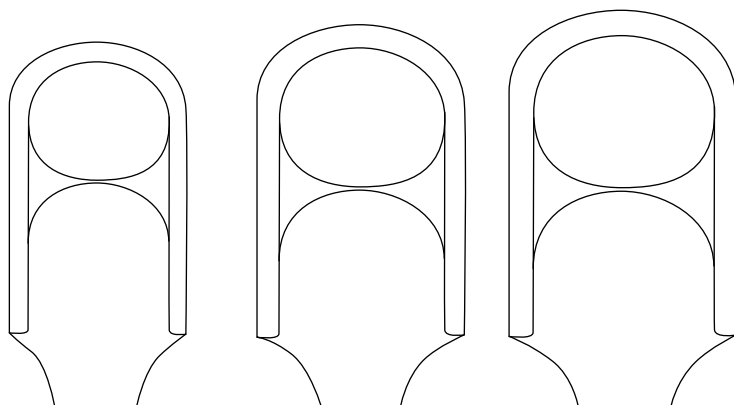

SLUDER-BALLENGER				
	Fig. 1	Fig. 2	Fig. 3	
	tk 52671-01	tk 52671-02	tk 52671-03	tk 52671-10

Griff
 Handle
 Manche
 Mango
 Manico

tk 52671-00	x	x	x	x
--------------------	---	---	---	---

komplett
 complete
 complet
 completa
 completa

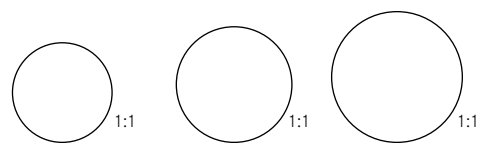

HARTMANN				
	13 mm Ø	15 mm Ø	17 mm Ø	
x = 120 mm	tk 52665-13	tk 52665-15	tk 52665-17	

Trachealdilatatoren
Trachea dilators

Dilatateurs pour la trachéotomie
Dilatadores para la tráqueotomía
Dilatatori tracheali



LABORDE

120 mm - 5"	tk 29950-12	
140 mm - 5½"		tk 29950-14

für Kinder
for children
pour enfants
para niños
per bambini

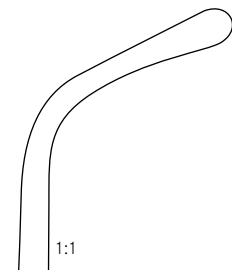

TROUSSEAU

120 mm - 5"	tk 29952-12	
140 mm - 5½"		tk 29952-14

für Kinder
for children
pour enfants
para niños
per bambini

Trachealkanülen | Canules pour la trachéotomie
Trachea tubes | *Cánulas para la tráquea*
Cannule tracheali



UCKERMANN

130 mm - 5"

10 mm Ø

tk 6163-13

1:2

**Tracheotomiebesteck
Tracheotomy set**
**Trousse pour la trachéotomie
Estuche para la traqueotomía
Astuccio per tracheotomia**

200 mm x 105 mm x 30 mm

tk 29997-00

Tracheotomiebesteck, in Metall-Etui, bestehend aus:

- 1 Griff, tk 7100-04/1 Klinge, Fig. 20, tk 7210-20 T
- 1 Griff, tk 7100-04/1 Klinge, Fig. 23, tk 7210-23 T
- 1 anatomische Pinzette, 130 mm, tk 10000-13
- 2 chirurgische Pinzetten, 1 x 2 Zähne, 130 mm, tk 11000-13
- 2 Rochester-Péan Klemmen, 130 mm, tk 12059-13
- 1 Hohlsonde, 130 mm, tk 18110-13
- 1 Bose Trachealdilatator, tk 17395-07
- 2 Iterson Trachealhäkchen, stumpf, tk 16922-16
- 1 Bose Trachealhäkchen, 160 mm, scharf, rechts, tk 16956-16
- 1 Bose Trachealhäkchen, 160 mm, scharf, links, tk 16957-16
- 1 Reinigungsbürste, tk 29999-26

Tracheotomy set, in metal case, consisting of:

- 1 Handle, tk 7100-04/1 blade, Fig. 20, tk 7210-20 T*
- 1 Handle, tk 7100-04/1 blade, Fig. 23, tk 7210-23 T*
- 1 Dressing forceps, 130 mm, tk 10000-13*
- 2 Tissue forceps, 1 x 2 teeth, 130 mm, tk 11000-13*
- 2 Rochester-Péan hemostatic forceps, 130 mm, tk 12059-13*
- 1 Grooved director, 130 mm, tk 18110-13*
- 1 Bose trachea dilator, tk 17395-07*
- 2 Iterson trachea retractors, blunt, tk 16922-16*
- 1 Bose trachea retractor, 160 mm, sharp, right, tk 16956-16*
- 1 Bose trachea retractor, 160 mm, sharp, left, tk 16957-16*
- 1 Cleaning brush, tk 29999-26*

Trousse pour la trachéotomie, en étui de métal, se composant de:

- 1 Manche, tk 7100-04/1 lame, Fig. 20, tk 7210-20 T
- 1 Manche, tk 7100-04/1 lame, Fig. 23, tk 7210-23 T
- 1 Pince à disséquer, 130 mm, tk 10000-13
- 2 Pinces à griffes, 1 x 2 griffes, 130 mm, tk 11000-13
- 2 Pinces hémostatiques de Rochester-Péan, 130 mm, tk 12059-13
- 1 Sonde cannelée, 130 mm, tk 18110-13
- 1 Dilatateur trachéal de Bose, tk 17395-07
- 2 Crochets trachéaux de Iterson, mousses, tk 16922-16
- 1 Crochet trachéal de Bose, 160 mm, pointu, à droite, tk 16956-16
- 1 Crochet trachéal de Bose, 160 mm, pointu, à gauche, tk 16957-16
- 1 Ecouvillon, tk 29999-26

Estuche para la traqueotomía, en estuche de metal, compuesto de:

- 1 Mango, tk 7100-04/1 hoja, Fig. 20, tk 7210-20 T*
- 1 Mango, tk 7100-04/1 hoja, Fig. 23, tk 7210-23 T*
- 1 Pinza de disección, 130 mm, tk 10000-13*
- 2 Pinzas quirúrgicas, 1 x 2 dientes, 130 mm, tk 11000-13*
- 2 Pinzas hemostáticas de Rochester-Péan, 130 mm, tk 12059-13*
- 1 Sonda acanalada, 130 mm, tk 18110-13*
- 1 Dilatador traqueal de Bose, tk 17395-07*
- 2 Separadores traqueales de Iterson, romos, tk 16922-16*
- 1 Separador traqueal de Bose, 160 mm, agudo, a la derecha, tk 16956-16*
- 1 Separador traqueal de Bose, 160 mm, agudo, a la izquierda, tk 16957-16*
- 1 Cepillo de limpieza, tk 29999-26*

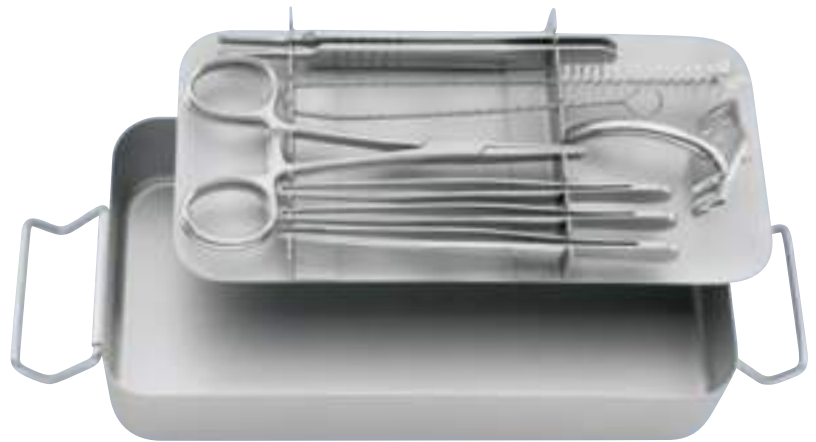

Astuccio per tracheotomia, contenente

- 1 Manico, tk 7100-04/1 lama, Fig. 20, tk 7210-20 T
- 1 Manico, tk 7100-04/1 lama, Fig. 23, tk 7210-23 T
- 1 Pinza anatomica, 130 mm, tk 10000-13
- 2 Pinze chirurgiche, 1 x 2 denti, 130 mm, tk 11000-13
- 2 Pinze Rochester-Péan, 130 mm, tk 12059-13
- 1 Sonda scanalata, 130 mm, tk 18110-13
- 1 Uncino di Bose, tk 17395-07
- 2 Uncini Iterson, smussa, tk 16922-16
- 1 Uncino Bose, 160 mm, acuta, a destra, tk 16956-16
- 1 Uncino Bose, 160 mm, acuta, a sinistra, tk 16957-16
- 1 Spazzolina per pulire, tk 29999-26

Kropffasszangen – Kropfsonden
Goitre grasping forceps – Goitre enucleator

Pincas à goitre – Spatules à goitre
Pinzas para coger el bocio – Sondas para bocio
Pinze per gozzo – Sonde per gozzo



MASTIN
 170 mm – 6½" **tk49905-17**

1:2



LAHEY
 150 mm – 6" **tk49900-15**
 200 mm – 8" **tk49900-20**

1:2



1:1

1:1

KOCHER
 150 mm – 6" **tk49925-15** **tk49927-15**
 160 mm – 6¼" **tk49925-16** **tk49927-16**

mit Loch
 with hole
 avec trou
 con orificio
 con foro

Broncho-Oesophagoskopiezangen
Broncho-oesophagscopy forceps

Pinces pour broncho-oesophagoscopie
Pinzas para bronco-esofagoscopia
 Pinze per bronco-oesophagoscopia



BRUENINGS

200 mm - 8"	tk 53391-20
300 mm - 12"	tk 53391-30
400 mm - 16"	tk 53391-40
500 mm - 20"	tk 53391-50
600 mm - 23½"	tk 53391-60

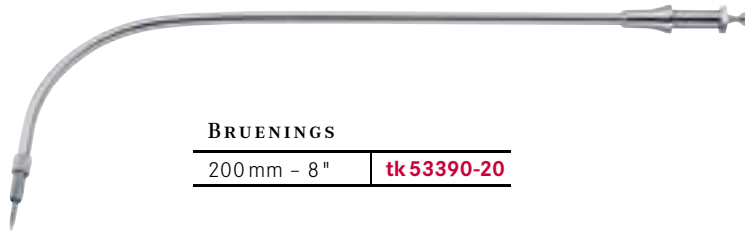

BRUENINGS

200 mm - 8"	tk 53390-20
-------------	--------------------



HUBER

tk 53375-01

1:2



Bitte fordern Sie unseren Spezialkatalog an.
Please ask for our special catalogue.

Veillez demander pour notre catalogue spécial.
Por favor preguntan para el catalogo especial.

Per favore domandate per il nostro catalogo speciale.

Broncho-Oesophagoskopiezangen
Broncho-oesophagocopy forceps

Pinces pour broncho-oesophagoscopie
Pinzas para bronco-esofagoscopia
Pinze per bronco-oesophagoscopia

Auswechselbare Zangenaufsätze
Exchangeable tips

Embouts interchangeables
Bocas intercambiables
Punte intercambiabili

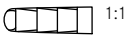

SEIFFERT
tk 53410-01

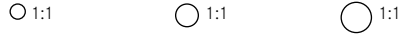

BRUENINGS
tk 53410-02 | **tk 53410-03** | **tk 53410-04**



LANGE
tk 53410-05



SCHEINMANN
tk 53410-06



FRAENKEL
tk 53410-16



FRAENKEL
tk 53410-07



KRAUSE
tk 53410-12



tk 53410-08 | **tk 53410-09**



tk 53410-10 | **tk 53410-11**



CORDES
tk 53410-13 | **tk 53410-14**

Broncho-Oesophagoskopiezangen
Broncho-oesophagoscopia forceps

Pinces pour broncho-oesophagoscopie
Pinzas para bronco-esofagoscopia
 Pinze per bronco-oesophagoscopia

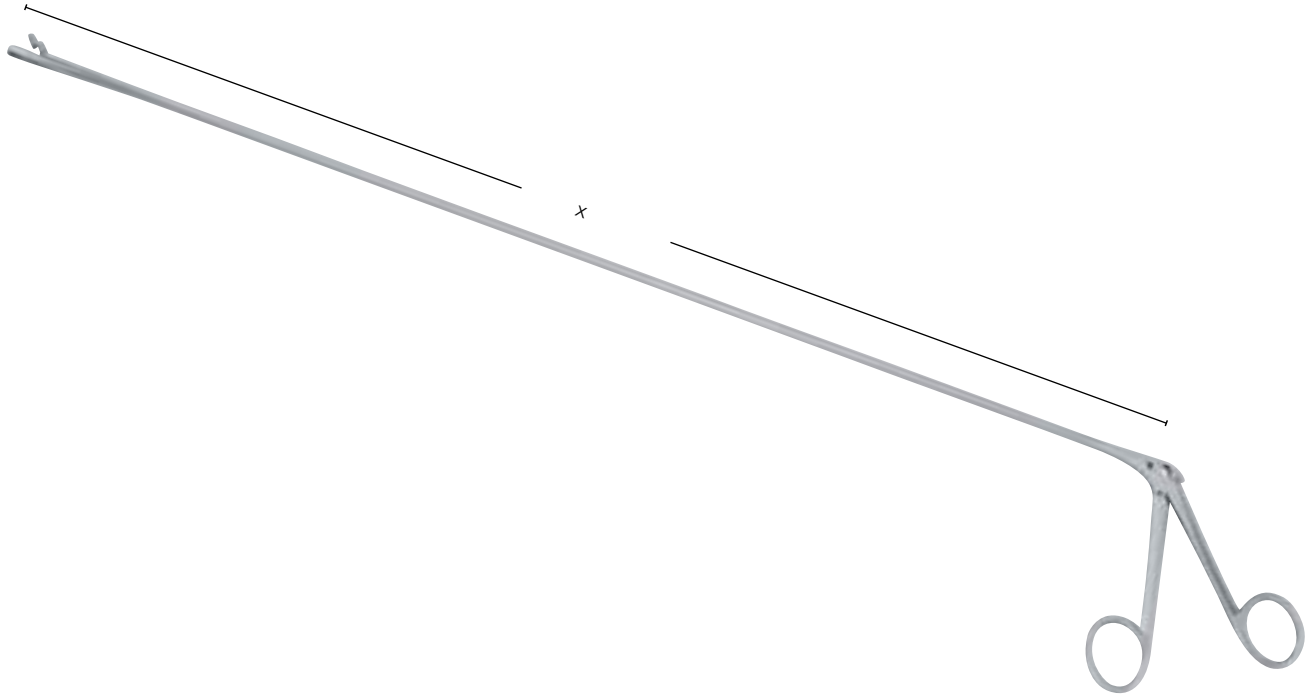

CHEVALIER-JACKSON



x = 300 mm - 12"	tk 53361-30	tk 53362-30	tk 53363-30	tk 53364-30
x = 400 mm - 16"	tk 53361-40	tk 53362-40	tk 53363-40	tk 53364-40
x = 500 mm - 20"	tk 53361-50	tk 53362-50	tk 53363-50	tk 53364-50
x = 600 mm - 23½"	tk 53361-60	tk 53362-60	tk 53363-60	tk 53364-60



x = 300 mm - 12"	tk 53365-30	tk 53366-30	tk 53367-30
x = 400 mm - 16"	tk 53365-40	tk 53366-40	tk 53367-40
x = 500 mm - 20"	tk 53365-50	tk 53366-50	tk 53367-50
x = 600 mm - 23½"	tk 53365-60	tk 53366-60	tk 53367-60

Mikro-Instrumente für Laryngo-Broncho-Oesophagoskopie
Micro-instruments for laryngo-broncho-oesophagoscopy

Micro-instruments pour laryngo-broncho-oesophagoskopie
Micro-instrumental para laringo-bronco-esofagoscopia
Micro-strumenti per laringo-bronco-esofagoscopia



2.0 mm

Schaft
Shaft
Gaine
Vaina
Asta

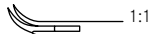
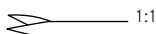
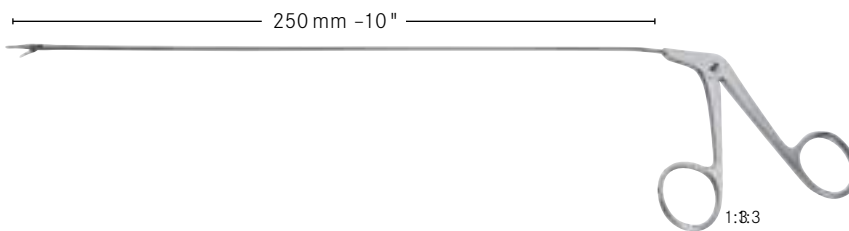

	tk 52673-01	tk 52673-02	tk 52673-04	tk 52673-05	tk 52673-06
Scheren Scissors Ciseaux Tijeras Forbice	gerade <i>straight</i> droit <i>recta</i> retta	gerade horizontal <i>straight horizontal</i> droit horizontal <i>recta horizontal</i> retta orizzontale	aufgebogen horizontal <i>angled up horizontal</i> coudé en haut coupe horizontal <i>curvada arriba horizontal</i> curvata in alto orizzontale	rechts gebogen <i>curved right</i> courbe à droite <i>curvada a derecha</i> curva a destra	links gebogen <i>curved left</i> courbe à gauche <i>curvada a izquierda</i> curva a sinistra

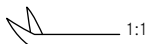

tk 52673-03

aufgebogen
angled up
coudé en haut
curvada arriba
curvata in alto

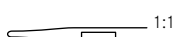

	tk 52674-01	tk 52674-02	tk 52674-04	tk 52674-05	tk 52674-06
Alligatorzangen <i>Alligator forceps</i> Pincés crocodile <i>Pinzas cocodrilo</i> Pinze cocodrillo	gerade, gerieft <i>straight, serrated</i> droit, strié <i>recta, estriada</i> retta, zigrinata	gerade horizontal <i>straight horizontal</i> droit horizontal <i>recta horizontal</i> retta orizzontale	aufgebogen horizontal <i>angled up horizontal</i> coudé en haut coupe horizontal <i>curvada arriba horizontal</i> curvata in alto orizzontale	rechts gebogen <i>curved right</i> courbe à droite <i>curvada a derecha</i> curva a destra	links gebogen <i>curved left</i> courbe à gauche <i>curvada a izquierda</i> curva a sinistra

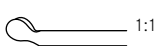

○ 2.5 mm	tk 52675-01	tk 52675-02	tk 52675-03	tk 52675-04	tk 52675-05
Löffelzangen <i>Cup shaped forc.</i> Pincés curettes <i>Pinzas cureta</i> Pinze a cucchaio	gerade <i>straight</i> droit <i>recta</i> retta	aufgebogen <i>angled up</i> coudé en haut <i>curvada arriba</i> curvata in alto	aufgebogen horizontal <i>angled up horizontal</i> coudé en haut coupe horizontal <i>curvada arriba horizontal</i> curvata in alto orizzontale	rechts gebogen <i>curved right</i> courbe à droite <i>curvada a derecha</i> curva a destra	links gebogen <i>curved left</i> courbe à gauche <i>curvada a izquierda</i> curva a sinistra

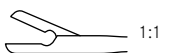

○ 3 x 5 mm tk 52675-06

Löffelzange
Cup shaped forc.
Pince curette
Pinza cureta
Pinza a cucchaio

oval
oval
ovale
oval
ovale

Mikro-Instrumente für Laryngo-Broncho-Oesophagoskopie
Micro-instruments for laryngo-broncho-oesophagoscopy

Micro-instruments pour laryngo-broncho-oesophagoscopie
Micro-instrumental para laringo-bronco-esofagoscopia
 Micro-strumenti per laringo-bronco-esofagoscopia

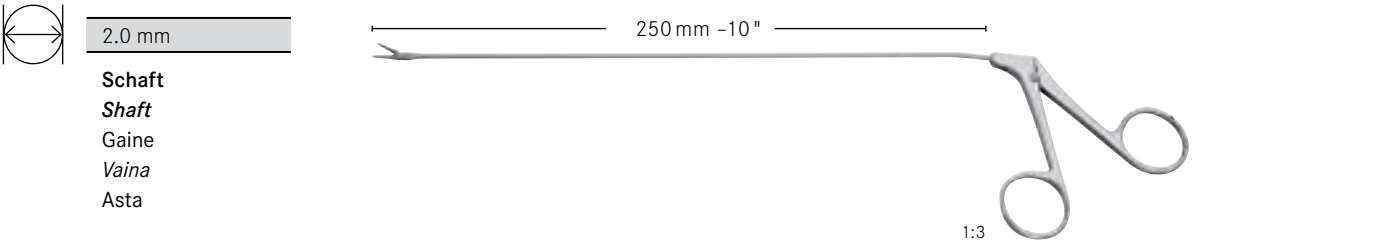

2.0 mm
 Schaft
 Shaft
 Gaine
 Vaina
 Asta



	tk 52676-01	tk 52676-02	tk 52676-04	tk 52676-05	tk 52676-06
--	-------------	-------------	-------------	-------------	-------------

Scheren <i>Scissors</i> Ciseaux <i>Tijeras</i> Forbice	gerade <i>straight</i> droit <i>recta</i> retta	gerade horizontal <i>straight horizontal</i> droit horizontal <i>recta horizontal</i> retta orizzontale	aufgebogen horizontal <i>angled up horizontal</i> coudé en haut coupe horizontal <i>curvada arriba horizontal</i> curvata in alto orizzontale	rechts gebogen <i>curved right</i> courbe à droite <i>curvada a derecha</i> curva a destra	links gebogen <i>curved left</i> courbe à gauche <i>curvada a izquierda</i> curva a sinistra
--	---	---	---	--	--

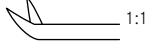

tk 52676-03

aufgebogen
angled up
 coudé en haut
curvada arriba
 curvata in alto

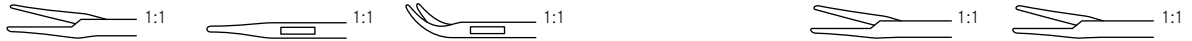

	tk 52677-01	tk 52677-02	tk 52677-04	tk 52677-05	tk 52677-06
--	-------------	-------------	-------------	-------------	-------------

Alligatorzangen <i>Alligator forceps</i> Pincés crocodile <i>Pinzas cocodrilo</i> Pinze coccodrillo	gerade <i>straight</i> droit <i>recta</i> retta	gerade horizontal <i>straight horizontal</i> droit horizontal <i>recta horizontal</i> retta orizzontale	aufgebogen horizontal <i>angled up horizontal</i> coudé en haut coupe horizontal <i>curvada arriba horizontal</i> curvata in alto orizzontale	rechts gebogen <i>curved right</i> courbe à droite <i>curvada a derecha</i> curva a destra	links gebogen <i>curved left</i> courbe à gauche <i>curvada a izquierda</i> curva a sinistra
---	---	---	---	--	--



○ 2.5 mm	tk 52678-01	tk 52678-02	tk 52678-03	tk 52678-04	tk 52678-05
----------	-------------	-------------	-------------	-------------	-------------

Löffelzangen <i>Cup shaped forc.</i> Pincés curettes <i>Pinzas cureta</i> Pinze a cucchaio	gerade <i>straight</i> droit <i>recta</i> retta	aufgebogen <i>angled up</i> coudé en haut <i>curvada arriba</i> curvata in alto	aufgebogen horizontal <i>angled up horizontal</i> coudé en haut coupe horizontal <i>curvada arriba horizontal</i> curvata in alto orizzontale	rechts gebogen <i>curved right</i> courbe à droite <i>curvada a derecha</i> curva a destra	links gebogen <i>curved left</i> courbe à gauche <i>curvada a izquierda</i> curva a sinistra
--	---	---	---	--	--

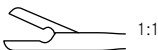

○ 3 x 5 mm	tk 52678-06
------------	-------------

Löffelzange <i>Cup shaped forc.</i> Pince curette <i>Pinza cureta</i> Pinza a cucchaio	oval <i>oval</i> ovale <i>oval</i> ovale
--	--

Mikro-Instrumente für Laryngo-Broncho-Oesophagoskopie
Micro-instruments for laryngo-broncho-oesophagoscopy

Micro-instruments pour laryngo-broncho-oesophagoscopie
Micro-instrumental para laringo-bronco-esofagoscopia
 Micro-strumenti per laringo-bronco-esofagoscopia

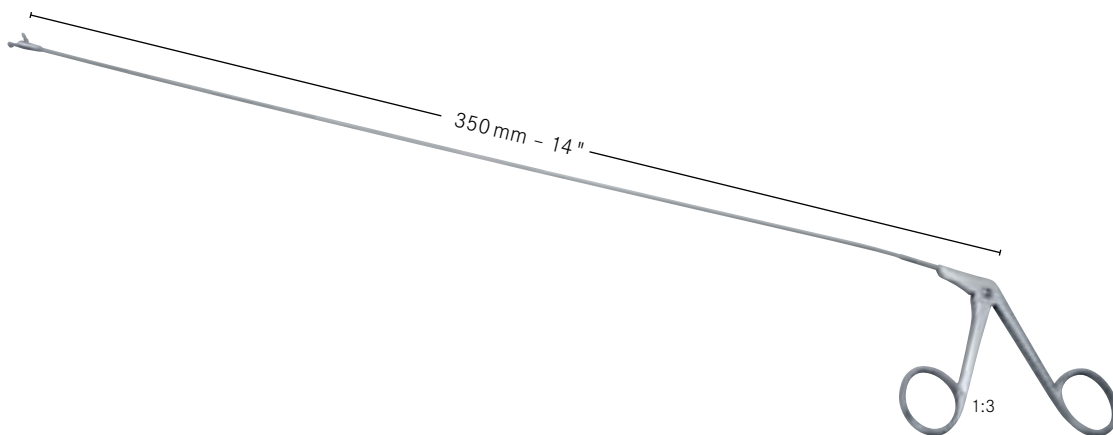

	tk 52680-01	tk 52680-02	tk 52680-03
Fasszange <i>Grasping forceps</i>	gerade, gerieft <i>straight, serrated</i>	gerade, gefenstert <i>straight, fenestrated</i>	gerade <i>straight</i>
Pince à saisir <i>Pinza agarre</i>	droit, striée <i>recta, estriada</i>	droit, fenêtrée <i>recta, fenestrada</i>	droits <i>recta</i>
Pinza da presa	retta, zigrinata	retta, fenestrata	retta

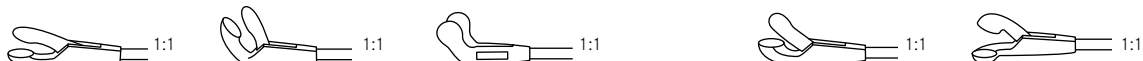

○ 3 mm	tk 52680-04	tk 52680-05	tk 52680-06	tk 52680-07	tk 52680-08
Löffelzangen <i>Cup shaped forc.</i>	gerade <i>straight</i>	aufgebogen <i>angled up</i>	aufgebogen horizontal <i>angled up horizontal</i>	rechts gebogen <i>curved right</i>	links gebogen <i>curved left</i>
Pincés curettes	droit	coudée en haut	coudée en haut coupe horizontalement	courbe à droite	courbe à droite
<i>Pinzas cureta</i>	<i>recta</i>	<i>curvada arriba</i>	<i>curvada arriba horizontal</i>	<i>curvada a derecha</i>	<i>curvada a izquierda</i>
Pinze a cucchaio	retta	curvata in alto	curvata in alto orizzontale	curva a destra	curva a sinistra



	tk 52680-09	tk 52680-10		tk 52680-11
Löffelzangen <i>Cup shaped forc.</i>	gerade <i>straight</i>	gerade <i>straight</i>		Universalzange <i>Universal forceps</i>
Pincés curettes	droit	droit		gerade <i>straight</i>
<i>Pinzas cureta</i>	<i>recta</i>	<i>recta</i>		Pince universelle <i>Pinza universal</i>
Pinze a cucchaio	retta	retta		droit <i>recta</i>
				retta <i>retta</i>

Mikro-Instrumente für Laryngo-Broncho-Oesophagoskopie
Micro-instruments for laryngo-broncho-oesophagocopy

Micro-instruments pour laryngo-broncho-oesophagoscopie
Micro-instrumental para laringo-bronco-esofagoscopia
 Micro-strumenti per laringo-bronco-esofagoscopia

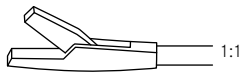
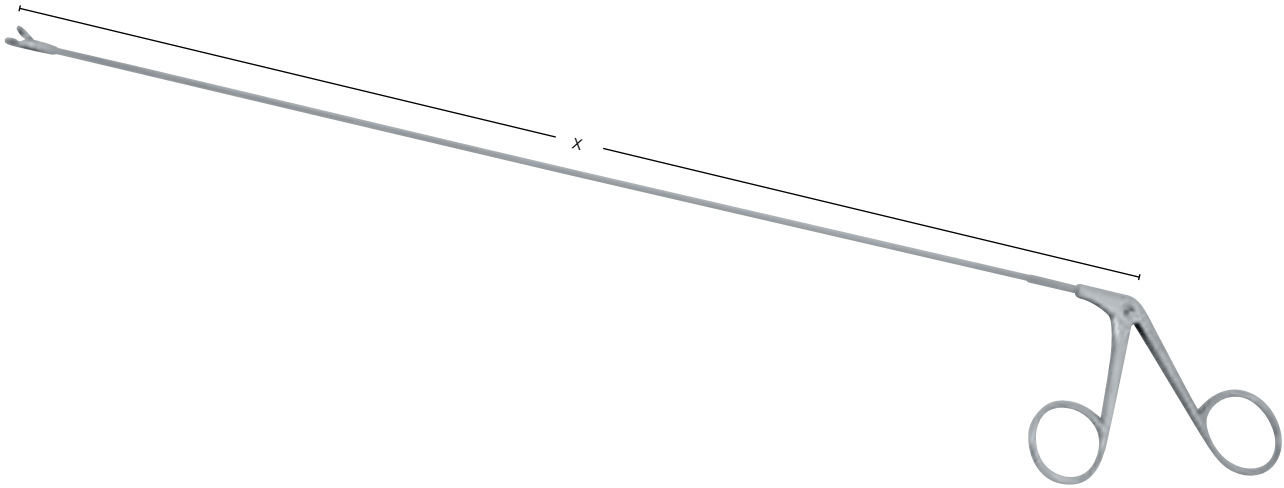

x = 400 mm - 16"	tk 52682-01
x = 500 mm - 20"	tk 52684-01
x = 600 mm - 23½"	tk 52686-01

Tumorzange, gerade
Punch forceps, straight
 Pince pour tumeurs, droit
Pinza para tumores, recta
 Pinza per tumori, retta

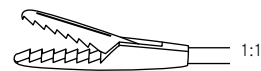

x = 400 mm - 16"	tk 52682-02	tk 52682-03	tk 52682-04
x = 500 mm - 20"	tk 52684-02	tk 52684-03	tk 52684-04
x = 600 mm - 23½"	tk 52686-02	tk 52686-03	tk 52686-04

Fasszangen <i>Grasping forceps</i>	gerade, gerieft <i>straight, serrated</i>	gerade, gefenstert <i>straight, fenestrated</i>	gerade <i>straight</i>
Pinces à saisir <i>Pinzas agarre</i> Pinze da presa	droit, striée <i>recta, estriada</i> retta, zigrinata	droit, fenêtrée <i>recta, fenestrada</i> retta, finestra	droit <i>recta</i> retta

Mikro-Instrumente für Laryngo-Broncho-Oesophagoskopie
Micro-instruments for laryngo-broncho-oesophagoscopy

Micro-instruments pour laryngo-broncho-oesophagoscopie
Micro-instrumental para laringo-bronco-esofagoscopia
 Micro-strumenti per laringo-bronco-esofagoscopia

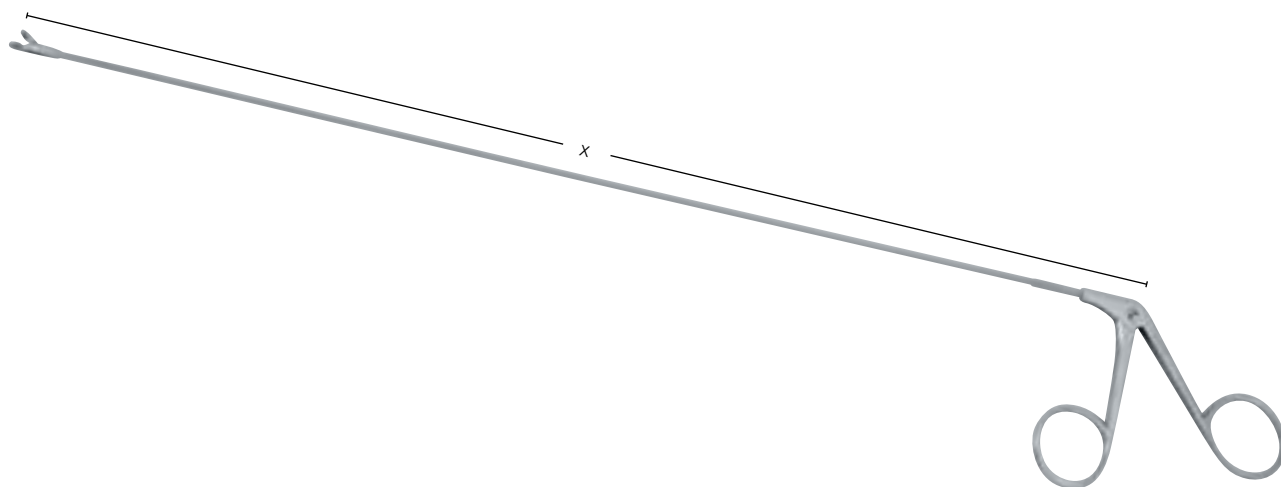

	4 mm	4 mm	4 mm	4 mm
x = 400 mm - 16 "	tk 52682-05	tk 52682-06	tk 52682-07	tk 52682-08
x = 500 mm - 20 "	tk 52684-05	tk 52684-06	tk 52684-07	tk 52684-08
x = 600 mm - 23½ "	tk 52686-05	tk 52686-06	tk 52686-07	tk 52686-08

Löffelzangen <i>Cup shaped forceps</i>	gerade <i>straight</i>	aufgebogen <i>angled up</i>	aufgebogen horizontal <i>angled up horizontal</i>	rechts gebogen <i>curved right</i>
Pinces à curette	droit	coudée en haut	coudée en haut coupe horizontalement	courbe à droite
<i>Pinzas cureta</i>	<i>recta</i>	<i>curvada arriba</i>	<i>curvada arriba horizontal</i>	<i>curvada a derecha</i>
Pinze a cucchaio	retta	curvata in alto	curvata orizzontalmente	curva a destra

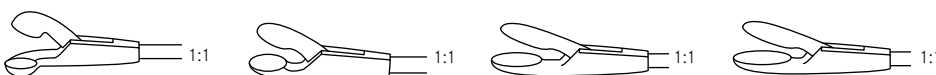

	4 mm	3 mm x 4 mm	4 mm x 6 mm	4 mm x 8 mm
x = 400 mm - 16 "	tk 52682-09	tk 52682-10	tk 52682-11	tk 52682-12
x = 500 mm - 20 "	tk 52684-09	tk 52684-10	tk 52684-11	tk 52684-12
x = 600 mm - 23½ "	tk 52686-09	tk 52686-10	tk 52686-11	tk 52686-12

Löffelzangen <i>Cup shaped forceps</i>	links gebogen <i>curved left</i>	gerade <i>straight</i>	gerade <i>straight</i>	gerade <i>straight</i>
Pinces mors curettes	courbe à gauche	droit	droit	droit
<i>Pinzas cureta</i>	<i>curvada a izquierda</i>	<i>recta</i>	<i>recta</i>	<i>recta</i>
Pinze a cucchaio	curva a sinistra	retta	retta	retta

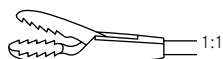

x = 400 mm - 16 "	tk 52682-13
x = 500 mm - 20 "	tk 52684-13
x = 600 mm - 23½ "	tk 52686-13

Universalzange <i>Universal forceps</i>	gerade <i>straight</i>
Pince universelle	droit
<i>Pinza universal</i>	<i>recta</i>
Pinza universale	retta

Kehlkopfpolypenzangen
Laryngeal polypus forceps

Pinces à polypes laryngiens
Pinzas para pólipos laringeos
Pinze per polipi laringei

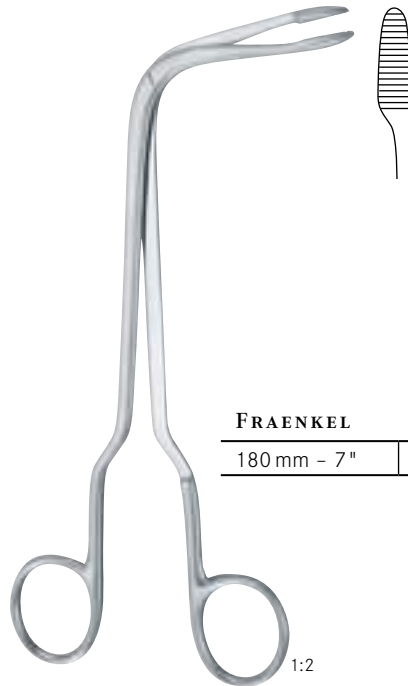

FRAENKEL

180 mm - 7"

tk 53561-18

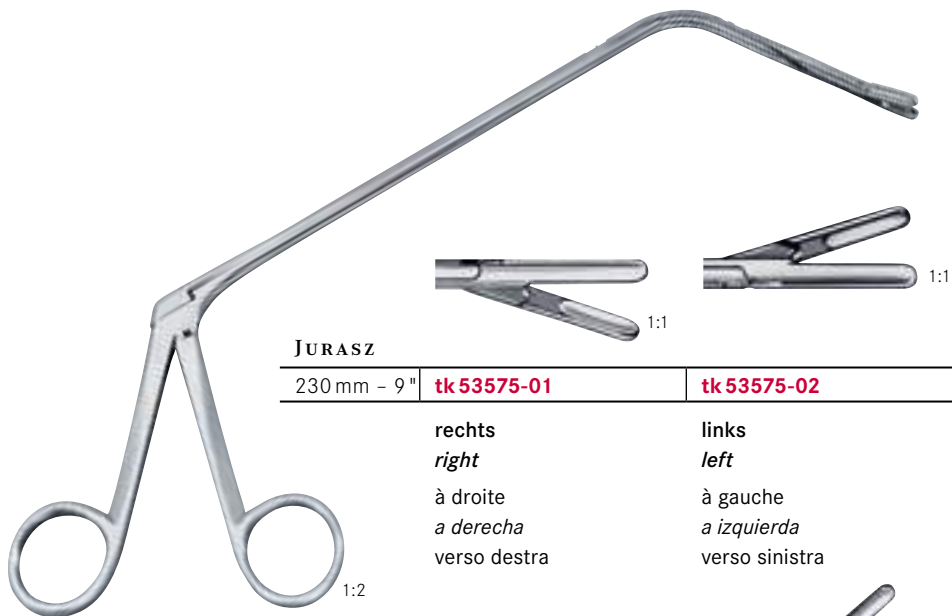

JURASZ

230 mm - 9"

tk 53575-01

tk 53575-02

rechts
right
à droite
a derecha
verso destra

links
left
à gauche
a izquierda
verso sinistra



tk 53575-03

nach unten
downwards
vers le bas
hacia abajo
verso basso



tk 53575-04

nach oben
upwards
vers le haut
hacia arriba
verso alto

Kehlkopfpolypenzangen
Laryngeal polypus forceps

Pinces à polypes laryngiens
Pinzas para pólipos laringeos
Pinze per polipi laringei

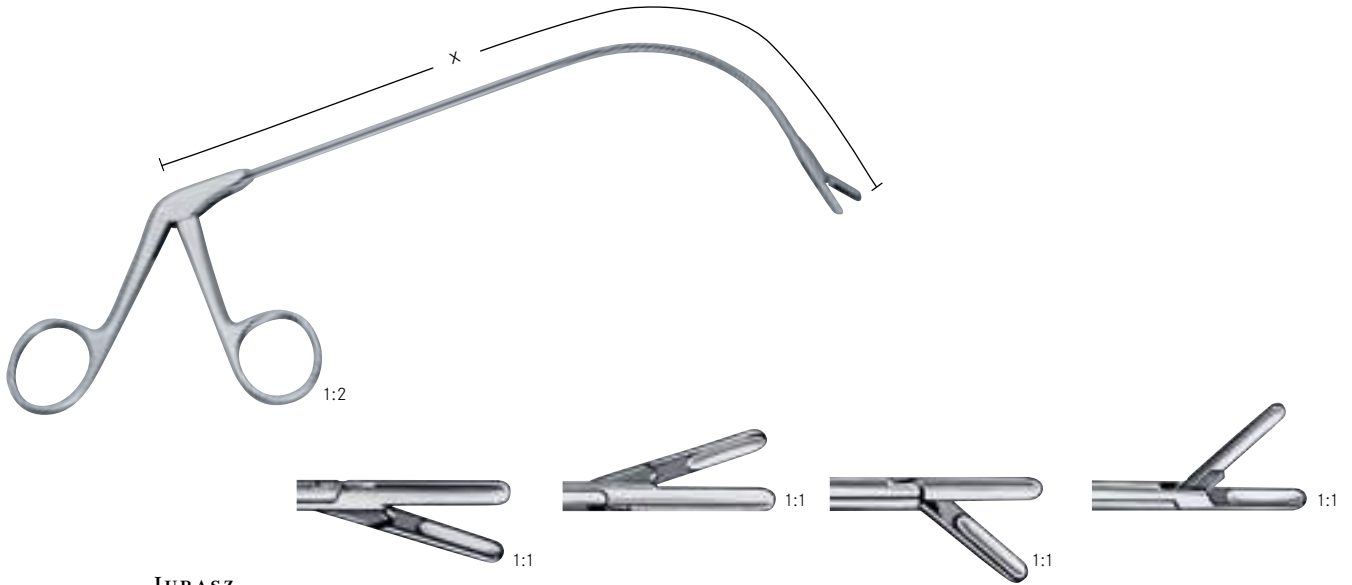

JURASZ

230 mm - 9"	tk 53580-01	tk 53580-02	tk 53580-03	tk 53580-04
rechts <i>right</i> à droite <i>a derecha</i> verso destra	links <i>left</i> à gauche <i>a izquierda</i> verso sinistra	nach unten <i>downwards</i> vers le bas <i>hacia abajo</i> verso basso	nach oben <i>upwards</i> vers le haut <i>hacia arriba</i> verso alto	

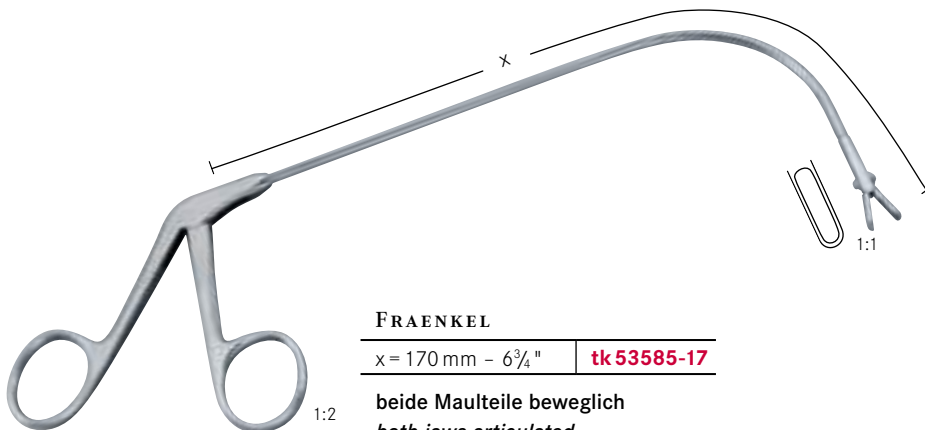

FRAENKEL

x = 170 mm - 6³/₄" **tk 53585-17**

beide Maulteile beweglich
both jaws articulated
les deux mâchoires mobiles
las dos mandíbulas móviles
ambedue i morsi mobili



Autopsie
Autopsy

Autopsie
Autopsia
Autopsia



Autopsie Instrumente
Instruments for autopsy

Instruments pour la autopsie
Instrumentos para la autopsia
Strumenti per autopsia



270mm - 10 3/4"
tk 54110-00

BRUNETTI

280 mm - 11 " | **tk 54112-28** | **tk 54113-28**

Meißel zur Öffnung der Wirbelsäule
Chisels for opening the spinal column
Burins pour ouvrir la colonne vertebrale
Cinceles para abrir la columna vertebral
Scalpelli per aprire la colonna vertebrale



220 mm - 8 3/4"
tk 54115-22

Rachiotom
Rachiotome
Rachiotome
Raquiotomo
Rachiotomo



130 mm - 5 "
x = 23 mm
tk 54114-13

Autopsie Instrumente
Instruments for autopsy

Instruments pour la autopsie
Instrumentos para la autopsia
Strumenti per autopsia



VIRCHOW

tk 54118-12

Schädelspalter
Skull breaker

Burin casse-crâne
Cinzel rompe craneo
Apri cranio

1:2



100 mm – 4 1/8"

tk 54410-02

Muskelhaken
Muscle hook

Crochet musculaire
Gancho muscular
Uncino muscolare

1:2



160 mm – 6 1/4"

10 mm x 50 mm

tk 54417-16

1:2



1:2



1:2

135 mm – 5 1/4"

tk 54420-13

tk 54421-13

Präpariernadeln
Dissecting needles

Aiguilles à préparation
Agujas para preparaciones
Aghi per preparazione

Autopsie-Besteck | Set à autopsie
Set of instruments for autopsy | *Juego de instrumentos para autopsia*
Astuccio completo per autopsia

tk 54120-00

Inhalt:

- 1 Skalpell mit Metallheft, tk 7000-03
- 1 Skalpell mit Metallheft, tk 7000-05
- 1 Skalpell mit Metallheft, tk 7000-07
- 1 Skalpell mit Metallheft, tk 7000-09
- 1 Virchow Amputationsmesser
- 1 anatomische Pinzette, tk 10000-13
- 1 Charrière Säge, tk 24005-30
- 1 Inzisionsschere, tk 8132-14
- 1 Hammer, tk 24054-01
- 1 Osteotom, tk 24092-13
- 1 Sonde, tk 18100-13
- 1 Muskelhaken, tk 54410-02
- 1 Tubulus
- 3 Sektionsnadeln

Contents:

- 1 Scalpel with metal handle, tk 7000-03
- 1 Scalpel with metal handle, tk 7000-05
- 1 Scalpel with metal handle, tk 7000-07
- 1 Scalpel with metal handle, tk 7000-09
- 1 Virchow amputations knife
- 1 Dressing forceps, tk 10000-13
- 1 Charrière saw, tk 24005-30
- 1 Incision scissor, tk 8132-14
- 1 Hammer, tk 24054-01
- 1 Osteotome, tk 24092-13
- 1 Probe, tk 18100-13
- 1 Hook, tk 54410-02
- 1 Tube
- 3 Dissecting needles

Contenu:

- 1 Bistouri avec manche en metal, tk 7000-03
- 1 Bistouri avec manche en metal, tk 7000-05
- 1 Bistouri avec manche en metal, tk 7000-07
- 1 Bistouri avec manche en metal, tk 7000-09
- 1 Virchow couteau à amputations
- 1 Pince anatomique, tk 10000-13
- 1 Scie Charrière, tk 24005-30
- 1 Ciseaux à incision, tk 8132-14
- 1 Marteau, tk 24054-01
- 1 Ostéotome, tk 24092-13
- 1 Stylet, tk 18100-13
- 1 Retracteur, tk 54410-02
- 1 Tube
- 3 Aiguilles de préparation

Contenido:

- 1 Bisturi con mango de metal, tk 7000-03
- 1 Bisturi con mango de metal, tk 7000-05
- 1 Bisturi con mango de metal, tk 7000-07
- 1 Bisturi con mango de metal, tk 7000-09
- 1 Virchow cuchillo de amputaciones
- 1 Pinza anatomica, tk 10000-13
- 1 Sierra Charrière, tk 24005-30
- 1 Tijera para incision, tk 8132-14
- 1 Martillo, tk 24054-01
- 1 Osteótomo, tk 24092-13
- 1 Sonda, tk 18100-13
- 1 Retractor, tk 54410-02
- 1 Tubo
- 3 Agujas para preparaciones

Contenuto:

- 1 Bisturi con manico di metallo, tk 7000-03
- 1 Bisturi con manico di metallo, tk 7000-05
- 1 Bisturi con manico di metallo, tk 7000-07
- 1 Bisturi con manico di metallo, tk 7000-09
- 1 Virchow coltello d'amputazione
- 1 Pinza anatomica, tk 10000-13
- 1 Charrière sega, tk 24005-30
- 1 Forbice per incisione, tk 8132-14
- 1 Martello, tk 24054-01
- 1 Osteotomo, tk 24092-13
- 1 Sonda, tk 18100-13
- 1 Retrattore, tk 54410-02
- 1 Tubo
- 3 Aghi per preparazione



Präparier-Besteck in Holzetui
Dissecting set in wooden case

Trousse à dissection, en boîte en bois
Estuche de disección en caja de madera
 Astuccio completo per dissezione in scatola di legno



tk 54200-00

Inhalt:

- 1 Anatomie-Skalpell
- 1 Anatomie-Skalpell
- 1 Anatomie-Skalpell
- 1 Inzisionsschere, 130 mm, tk 8132-13
- 1 anatomische Pinzette, 145 mm, tk 10000-14
- 1 Knopfsonde, 145 mm, tk 18100-14
- 1 Präpariernadel mit Holzheft
- 1 Knorpelmesser mit Schaber

Contents:

- 1 *Dissecting scalpel*
- 1 *Dissecting scalpel*
- 1 *Dissecting scalpel*
- 1 *Incision scissors, 130 mm, tk 8132-13*
- 1 *Dissecting forceps, 145 mm, tk 10000-14*
- 1 *Probe, 145 mm, tk 18100-14*
- 1 *Microscopic needle with wooden handle*
- 1 *Cartilage knife with raspatory*

Contenu:

- 1 Bistouri à dissection
- 1 Bistouri à dissection
- 1 Bistouri à dissection
- 1 Ciseaux à incision, 130 mm, tk 8132-13
- 1 Pince à dissection, 145 mm, tk 10000-14
- 1 Stylet boutonné, 145 mm, tk 18100-14
- 1 Aiguille à dissection avec manche en bois
- 1 Couteau à cartilages

Contenido:

- 1 *Bisturi de disección*
- 1 *Bisturi de disección*
- 1 *Bisturi de disección*
- 1 *Tijeras para incisión, 130 mm, tk 8132-13*
- 1 *Pinza de disección, 145 mm, tk 10000-14*
- 1 *Estilete abotonado, 145 mm, tk 18100-14*
- 1 *Aguja de disección con mango de madera*
- 1 *Cuchillo para cartilagos*

Contenuto:

- 1 Bisturi da dissezione
- 1 Bisturi da dissezione
- 1 Bisturi da dissezione
- 1 Forbice da incisione, 130 mm, tk 8132-13
- 1 Pinza per dissezione, 145 mm, tk 10000-14
- 1 Sonda bottonuta, 145 mm, tk 18100-14
- 1 Ago da dissezione con manico di legno
- 1 Bisturi da cartilagine

Mikroskopier-Besteck in Holzetui
Microscopic instrument set in wooden case

Trousse pour microscopie, en boîte en bois
Estuche de microscopía en caja de madera
 Astuccio completo per il microscopio in scatola di legno



1:2

tk 54300-00

Inhalt:

- 1 feine Präpariernadel, gerade
- 1 feine Präpariernadel, abgewinkelt
- 1 feine Präpariernadel, hakenförmig
- 1 Präpariermeißel
- 1 Mikroskopiermesser, gebogen
- 1 Mikroskopierpinzette, gerade
- 1 Mikroskopierpinzette, gebogen
- 1 Mikroskopierpinzette, gerade, gekreuzt, selbsthaltend
- 1 Mikroskopierschere, gerade, extra fein

Contents:

- 1 Dissecting needle, fine, straight
- 1 Dissecting needle, angled
- 1 Dissecting needle, hook shaped
- 1 Dissecting chisel
- 1 Dissecting scalpel, curved
- 1 Dissecting forceps, straight
- 1 Dissecting forceps, curved
- 1 Dissecting forceps, straight, cross action, self-retaining
- 1 Dissecting scissors, straight, very fine

Contenu:

- 1 Aiguille à dissection, très fine, droite
- 1 Aiguille à dissection, très fine, coudée
- 1 Aiguille à dissection, très fine, en forme de crochet
- 1 Ciseau-burin
- 1 Bistouri à dissection, courbe
- 1 Pince à dissection, fine, droite
- 1 Pince à dissection, fine, coudée
- 1 Pince à dissection, fine, droite, autostatique
- 1 Ciseaux à dissection, droite, très fins

Contenido:

- 1 Aguja de disección, muy fina, recta
- 1 Aguja de disección, muy fina, acodada
- 1 Aguja de disección, muy fina, en forma de gancho
- 1 Cíncel de disección
- 1 Bisturi de disección, curva
- 1 Pinza de disección, fina, recta
- 1 Pinza de disección, acodada
- 1 Pinza de disección, recta, cruzada, autostática
- 1 Tijera de disección, recta, muy fina

Contenuto:

- 1 Ago da dissezione, fino, retto
- 1 Ago da dissezione, acotato
- 1 Ago da dissezione, acotato, forma uncino
- 1 Scalpello, fino
- 1 Coltello, fino
- 1 Pinza per dissezione, fine, retta
- 1 Pinza per dissezione, fine, curva
- 1 Pinza per dissezione, fine, retta, a pressione continua
- 1 Forbice per dissezione, retta, molto fine

Oszillierende Elektro Autopsiesäge TEKNO Power
Oscillating Electric autopsy saw TEKNO Power

Scie électronique oscillante pour la autopsie TEKNO Power
Sierra electronica oscilante para la autopsia TEKNO Power
 Sega elettrica oscillante per autopsia TEKNO Power



Sägekopf autoklavierbar
Saw head autoclavable
 Tête autoclavable
Cabezal autoclavable
 Testina autoclavabile



230 V / 50 Hz	tk 54130-01	tk 54131-01
120 V / 60 Hz	tk 54130-02	tk 54131-02

Standardanschluss
Standard connector
 Standard connection
Standard connector
 Standard conettore

mit 3-Kant Anschluss inkl. Schaft, 39 mm
with triangle connector incl. arber, 39 mm
 avec connexion, triangulare, tige 39 mm
con connector triangular, tige 39 mm
 con conettore, triangole, asta 39 mm

Oszillierende Elektro Autopsiesäge TEKNO Power
Oscillating Electric autopsy saw TEKNO Power

Scie électronique oscillante pour la autopsie TEKNO Power
Sierra electronica oscilante para la autopsia TEKNO Power
 Sega elettrica oscillante per autopsia TEKNO Power

Komplett mit:

1 Sägeblatt Ø 50mm
 1 Sägeblatt Ø 65 mm
 1 Segmentsägeblatt
 1 Inbusschlüssel T
 Schmierstoffe
 5m Netzkabel(230V)
 3m Netzkabel (120V)
 Gabelschlüssel 11mm, 14mm
 Gebrauchsanleitung

Technische Daten:

Leistungsaufnahme 500W
 Gewicht 1,25 kg
 3500-24000 Schwingungen p. Minute
 Nur 52-77db(A)
 Motor doppelschutzisoliert (Klasse II)
 CE-Konform
 Geprüft nach EN60601-1 /-1-2

Complete with:

1 Sawblade Ø 50mm
 1 Sawblade Ø 65mm
 1 segment sawblade
 1 hollow screw wrench T
 Grease
 5m mains cable (230V)
 3m mains cable (120V)
 Wrenches 11mm, 14mm
 Instruction manual

Technical data:

Consumption 500W
 Weight 1,25kg
 3500-24000 osc per minute
 Only 52-77db (A)
 Double isolated protection of the engine
 (class II)
 According to CE
 Tested according to EN 60601-1/-1-2

Complet avec:

1 Lame de Ø50mm
 1 Lame de Ø65mm
 1 scie á segmental
 1 Clé pour vis hexagonales
 Lubrifiant
 5m Cable RED (230V)
 3m Cable RED (120V)
 Clés à fourche 11mm, 14mm
 Mode d' emploi

Dates techniques:

Puissance absorbée 500W
 Poids 1, 25 kg
 3500-24000 oscillations par minute
 52-77 db(A)
 Double isolation du moteur (class II)
 Conforme au CE
 Testé selon EN 60601-1/-1-2

Completo con:

1 Hoja de Ø50mm
 1 Hoja de Ø65mm
 1 hoja de segmento
 1 Llave para tornillos hexagonales
 Lubrificante
 5m Cable RED (230V)
 3m Cable RED (120V)
 Llaves de tuercas 11mm, 14mm
 Manual de Usuario

Datos tecnicos:

Absorcion de potencia 500W
 Peso 1,25 Kg
 3500-24000 oscilaciones /min.
 52-77 db(A)
 Doble aislante del motor (classe II)
 Conforme a las normas CE
 Testado segun EN 60601-1/-1-2

Completa con:

1 Lama Ø50mm
 1 Lama Ø65mm
 1 Lama segmentale
 1 chiave
 Lubrificante
 Cavo di alimentazione 5 metri (230V)
 Cavo di alimentazione 3 metri (120V)
 Chiavi di montaggio 11mm,14mm
 Manuale di istruzione

Dati tecnici:

Asorbimento 500W
 Peso 1,25kg
 35000-24000 oscilazioni/min.
 Solamente 52-77 db(A)
 Doppio isolamento del motore (classe II)
 In accord al marchio CE
 EN 60601-1/-1-2

Sägeblätter
Saw blades

Lames de scie
Hojas de sierra
Lame per sega

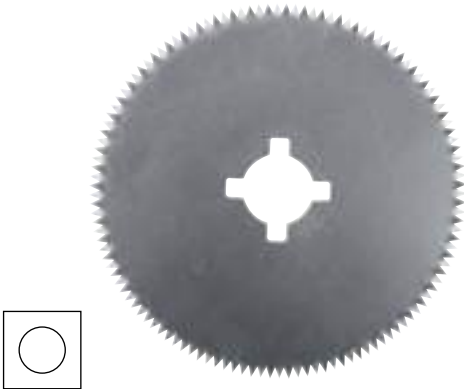

Ø 50 mm	tk 24006-02
Ø 65 mm	tk 24006-03

Sägeblatt
Saw blade
Lame de scie
Hoja
Lama



Ø 50 mm	tk 54132-10
Ø 65 mm	tk 54132-11

Sägeblatt
Saw blade
Lame de scie
Hoja
Lama



Ø 50 mm	tk 54133-01
---------	--------------------

Segmentsägeblatt
Segment saw blade
Scie à segments
Hoja de segmento
Lama segmentale



Ø 50 mm	tk 54132-01
---------	--------------------

Segmentsägeblatt
Segment saw blade
Scie à segments
Hoja de segmento
Lama segmentale

Sägeblätter
Saw blades

Lames de scie
Hojas de sierra
Lame per sega



Ø 65 mm	tk 24006-03	tk 54133-05
---------	--------------------	--------------------

Tiefensägeblatt mit Excenter Ring
für eine Schnittiefe von 4-11 mm

*Circular saw blade with eccentric ring
to vary the depth of the cut from 4-11 mm*

Scie circulaire avec disque excentrique permettant
de faire varier la profodeur de coupe de 4-11 mm

*Hoja circular con excéntrica para variar la
profandidad del corte de 4-11 mm*

Lama circolare con limitatore eccentrico per
profondità di taglio differenziate da 4-11 mm



Ø 65 mm	tk 54132-05
---------	--------------------

Tiefensägeblatt mit Excenter Ring
für eine Schnittiefe von 4-11 mm

*Circular saw blade with eccentric ring
to vary the depth of the cut from 4-11 mm*

Scie circulaire avec disque excentrique permettant
de faire varier la profodeur de coupe de 4-11 mm

*Hoja circular con excéntrica para variar la
profandidad del corte de 4-11 mm*

Lama circolare con limitatore eccentrico per
profondità di taglio differenziate da 4-11 mm



x = 8 mm	tk 54133-03
x = 20 mm	tk 54133-02

Tiefensägeblatt
Depth saw blade

Scie en profondeur
Hoja de profundidad
Lama profunda



x = 8 mm	tk 54132-03
x = 20 mm	tk 54132-02

Tiefensägeblatt
Depth saw blade

Scie en profondeur
Hoja de profundidad
Lama profunda

Sägeblätter
Saw blades

Lames de scie
Hojas de sierra
Lame per sega



Ø 45 mm | **tk 54132-06**

Doppelsägeblatt komplett
Circular double saw blade

Scie jumelée, ciculaire
Hoja circular, doble
Lama doppia, circolare



tk 54133-06

Sägeblatt (1)
Saw blade (1)

Lame de scie (1)
Hoja (1)
Lama (1)



tk 54133-07

Sägeblatt (2)
Saw blade (2)

Lame de scie (2)
Hoja (2)
Lama (2)



tk 54133-12

Schaft
Shaft

Tige
Tija
Asta

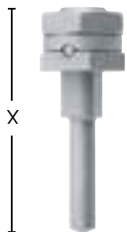

x = 39 mm	tk 54133-10
x = 58 mm	tk 54133-11



Verschiedenes
Miscellaneous

Articles divers
Diversos artículos
Articoli vari



Bleihände | Manches en plomb
Lead hands | Manos de plomo
| Mani di piombo

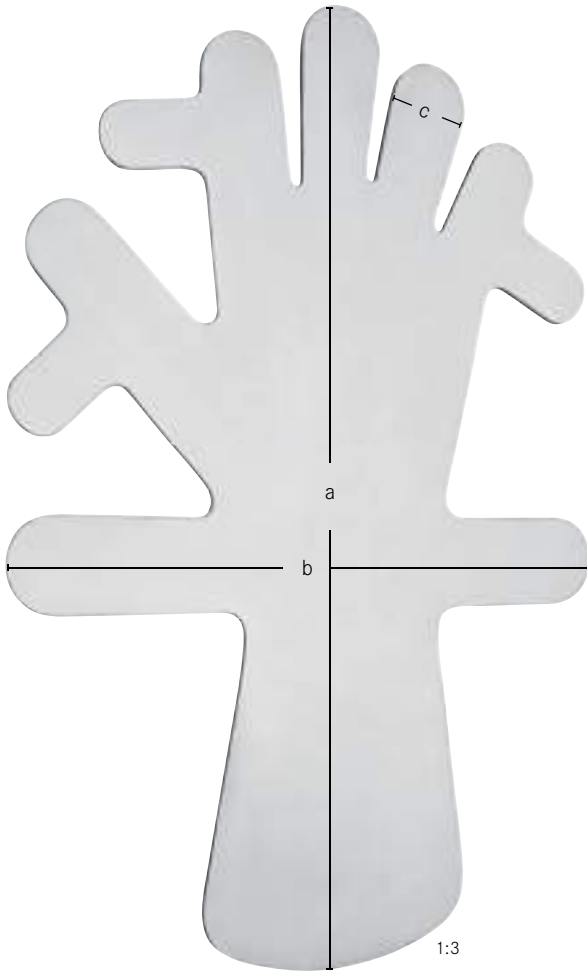

tk48180-01	tk48180-02
-------------------	-------------------

für Kinder <i>for children</i> pour enfants <i>para niños</i> per bambini	für Erwachsene <i>for adults</i> pour adultes <i>para adultos</i> per adulti
---	--

tk48180-04	0,25 Kg
-------------------	---------

tk48180-03	0,75 Kg
-------------------	---------

für Erwachsene, mit Silikonüberzug
adult size with silicone coating

pour adultes, avec couche de silicone
para adultos, con cubierta de silicon
per adulti, rivestito di silicone

	a	b	c	d
tk48180-01	250 mm	180 mm	25 mm	-
tk48180-02	325 mm	250 mm	25 mm	-
tk48180-03	330 mm	220 mm	35 mm	75 mm
tk48180-04	330 mm	220 mm	35 mm	75 mm

Instrumente für Finger- und Zehennägel
Nail instruments

Instruments à ongles
Instrumentos para uñas
Strumenti per unghie



1:2

MARTÍN-IDEAL

tk48184-10

komplett mit Fig. 1 – 3
complete with Fig. 1 – 3
complet avec Fig. 1 – 3
completa con Fig. 1 – 3
completo con Fig. 1 – 3



1:1

1:1

1:1

	Fig. 1	Fig. 2	Fig. 3
	tk48185-01	tk48185-02	tk48185-03
tk48185-00	x	x	x

Satz
Set
Jeu
Juego
Serie



1:2

FELDHEIM

100 mm – 4" tk48182-10

Finger- und Zehenkompressorium
Tourniquet for fingers and toes

Tourniquet pour doigts des mains et pieds
Tourniquete para los dedos de manos y piés
Compressorio per dita di mano e piede



1:2

RADOLF

135 mm – 5 1/4" tk48196-13



1:2

ANVIL

125 mm – 5" tk48197-12

Fingerringsägen
Finger ring saws

Scies pour couper des bagues
Sierras para abrir anillos
 Seghe per anelli



1:2

170 mm - 6 $\frac{3}{4}$ "

tk48188-17

tk48188-01

Sägeblatt allein
Blade only

Lame seule
Hoja sola
 Lama sola



1:2

WALTON

160 mm - 6 $\frac{1}{4}$ "

tk48190-16

tk48190-01

Sägeblatt allein
Blade only

Lame seule
Hoja sola
 Lama sola



1:2

170 mm - 6 $\frac{3}{4}$ "

tk48192-17

tk48192-01

Sägeblatt allein
Blade only

Lame seule
Hoja sola
 Lama sola

Lupuslöffel
Lupus curettes

Curettes pour les lupus
Curetas para lupus
Curette per lupus

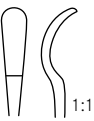
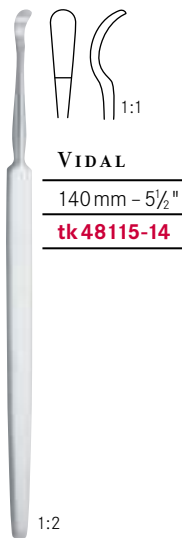

VIDAL

140mm – 5½"

tk48115-14



Fox



	Fig. 1	Fig. 2	Fig. 3	Fig. 4
	3 mm Ø	4 mm Ø	5 mm Ø	6 mm Ø
140mm – 5½"	tk48120-01	tk48120-02	tk48120-03	tk48120-04



WOLFF



	Fig. 1	Fig. 2	Fig. 3	Fig. 4	Fig. 5	Fig. 6
140mm – 5½"	tk48125-01	tk48125-02	tk48125-03	tk48125-04	tk48125-05	tk48125-06

Häkchen | Crochets
 Hooklets | Ganchos
 | Uncini

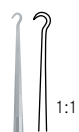

KILNER

150 mm - 6"	tk48128-15
-------------	-------------------

1:2

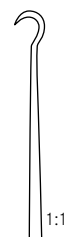
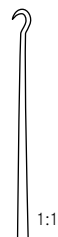

GILLIES







	Fig. 1	Fig. 2
180 mm - 7"	tk48130-01	tk48130-02

1:2

Trephinen | Trépan
 Trephines | Trépanos
 Trefine



1:2

KEYES	 1:1	 1:1	 1:1	 1:1	 1:1	 1:1	 1:1
	Fig. 1	Fig. 2	Fig. 3	Fig. 4	Fig. 5	Fig. 6	Fig. 7
	2 mm Ø	3 mm Ø	4 mm Ø	5 mm Ø	6 mm Ø	7 mm Ø	8 mm Ø
120 mm - 4 3/4"	tk 48150-02	tk 48150-03	tk 48150-04	tk 48150-05	tk 48150-06	tk 48150-07	tk 48150-08

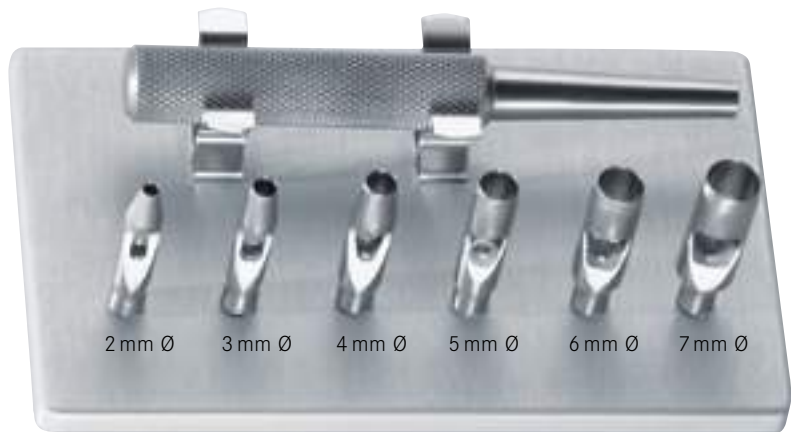

1:1

KEYES

tk 48147-00







Hautstanze – komplett mit 6 auswechselbaren Aufsätzen, Ø 2 mm – 7 mm

Punch – complete with 6 interchangeable tips, Ø 2 mm – 7 mm

Poinçon – complet avec 6 pointes interchangeables, Ø 2 mm – 7 mm

Punzón – completo con 6 puntas intercambiables, Ø 2 mm – 7 mm

Punzone – completo con 6 testine intercambiabili, Ø 2 mm – 7 mm

KEYES	 1:1	 1:1	 1:1	 1:1	 1:1	 1:1
	2 mm Ø	3 mm Ø	4 mm Ø	5 mm Ø	6 mm Ø	7 mm Ø
120 mm - 4 3/4"	tk 48147-02	tk 48147-03	tk 48147-04	tk 48147-05	tk 48147-06	tk 48147-07

Aufsätze

Tips

Pointes

Puntas

Testine

KEYES

120 mm - 4 3/4" **tk 48147-01**

Griff, allein
 Handle, only

Manche, seul
 Mango, solo
 Manico, solo



1:2

HOLTH

90 mm - 3 1/2"

2 mm

tk 40760-09

Hautstanze

Punch

Poinçon

Punzón

Punzone

Komedoneninstrumente
Comedone extractors

Tire-comédons
Saca-comedones
Tiracomedoni

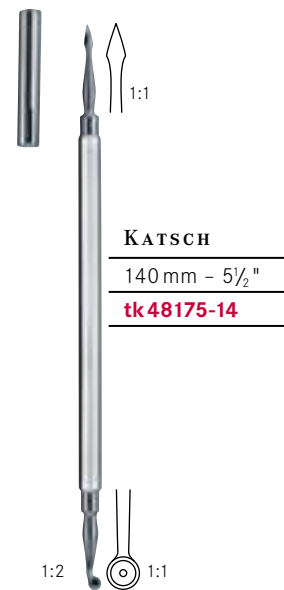
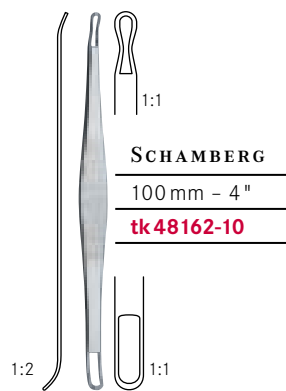
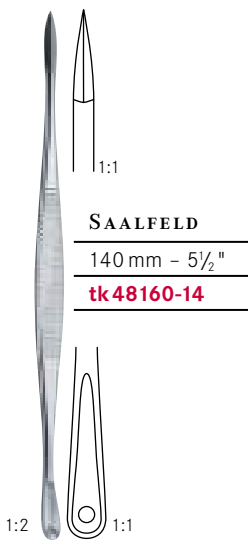
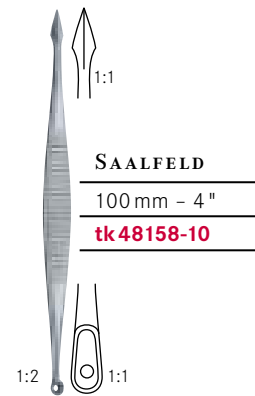
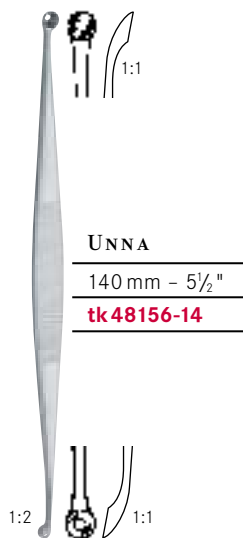
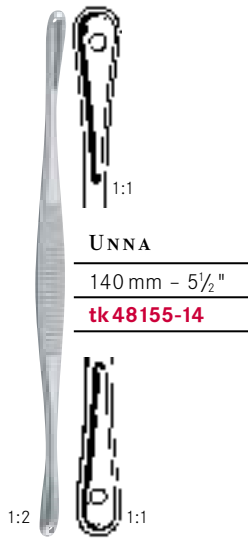

Infusionsflaschenöffnungszange
Forceps to open infusion bottles

Pince pour ouvrir des bouteilles d'infusion
Pinza para abrir botellas de infusión
Pinza apriflebo



200 mm – 8"

tk 32560-20

Sterilisierzangen - Abfallzangen
Sterilizing forceps - waste forceps

Pinces à stérilisation - pincés à déchets
 Pinzas de esterilización - pinzas de basuras
 Pinze per sterilizzazione - pinze per rifiuti



CHEATLE 1:2
 270 mm - 10³/₄ " **tk 55100-00**



ROGGE 1:2
 230 mm - 9 " **tk 55102-23**



200 mm - 8 "	tk 55104-20
300 mm - 12 "	tk 55104-30

Sterilisierzangen – Sterilisierklammern – Kappenzangen
Sterilizing forceps and pins – forceps with lid

Pinces à stérilisation – pincen en boîtiers avec couvercles
Pinzas y cadres de esterilización – combinación tapa/pinza
 Pinze e spille per sterilizzazione – pinze porta cotoni

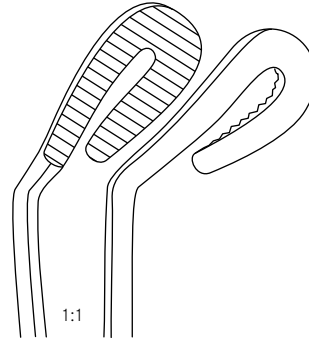
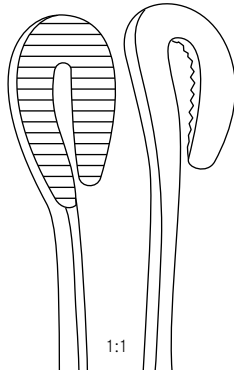
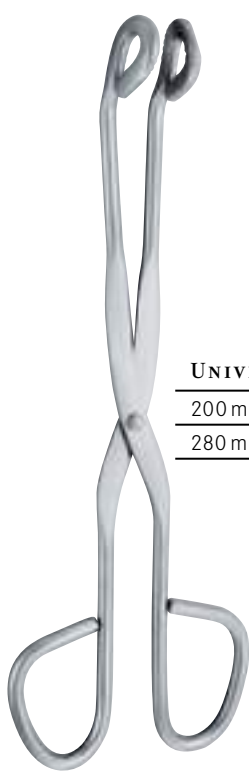

UNIVERSAL

200 mm – 8"

tk 55105-20

tk 55103-20

280 mm – 11"

tk 55105-28

tk 55103-28



BUNT

120 mm – 4¾"

tk 55108-12



MAYO

140 mm – 5½"

tk 55109-14



250 mm – 9¾"

tk 55345-25

320 mm – 12½"

tk 55345-32

- 1 Kornzange, gebogen, mit Sperre mit Deckel
- 1 Standgefäß mit großer, standsicherer Bodenplatte
- 1 Tampon forceps, curved, with ratchet with lid for jar
- 1 Jar with wide bottom plate
- 1 Pince à tampons, courbe, avec crémaillère
- 1 Boîtier, stable
- 1 Pinza para tampones con cremallera
- 1 Cazoleta de metal
- 1 Pinza per medicatura
- 1 Recipiente metallico

1:3

Handwaschbürste – Bürstenspender
Hand and nail brush – brush dispensers

Brosse à ongles – distributeurs de brosses
Cepillo para uñas – dispensadores de cepillos
 Spazzola per unghie – distributore per spazzole



tk4950-00

Handwaschbürste
Brush
 Brosse
Cepillo
 Spazzola

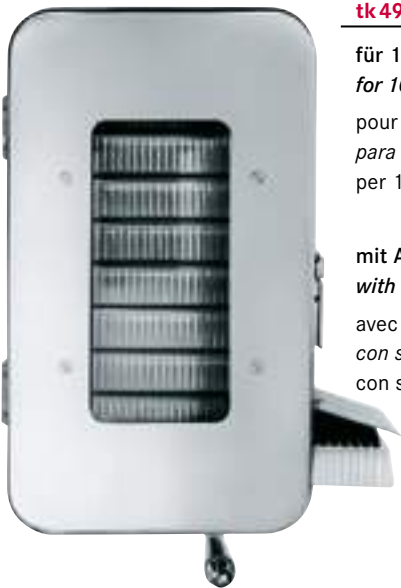

tk4960-10

für 10 Bürsten (ohne Bürsten)
for 10 brushes (without brushes)
 pour 10 brosses (sans brosses)
para 10 cepillos (sin cepillos)
 per 10 spazzole (senza spazzole)

mit Aufhängevorrichtung
with suspension
 avec suspension
con suspensión
 con suspensione

tk4962-20

für 20 Bürsten (ohne Bürsten)
for 20 brushes (without brushes)
 pour 20 brosses (sans brosses)
para 20 cepillos (sin cepillos)
 per 20 spazzole (senza spazzole)

mit Aufhängevorrichtung
with suspension
 avec suspension
con suspensión
 con suspensione

tk4963-20

für 20 Bürsten (ohne Bürsten)
for 20 brushes (without brushes)
 pour 20 brosses (sans brosses)
para 20 cepillos (sin cepillos)
 per 20 spazzole (senza spazzole)

ohne Aufhängevorrichtung
without suspension
 sans suspension
sin suspensión
 senza suspensione

Nadel-Sterilisierkästen
Sterilizing trays for needles

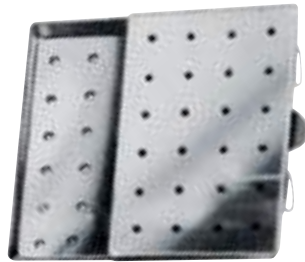
 Boîtes à stérilisation des aiguilles
 Cajas de esterilización para agujas
 Scatole per sterilizzazione aghi

50.0 mm x 25.0 mm x 4.5 mm	tk 55210-50
65.0 mm x 42.0 mm x 8.0 mm	tk 55210-65
75.0 mm x 25.0 mm x 4.5 mm	tk 55210-75

18/8 rostfrei	gelocht
18/8 stainless steel	perforated
18/8 inoxydable	perforé
18/8 inoxidable	perforado
18/8 inossidabile	perforato



65 mm Ø x 17 mm	tk 55250-65
-----------------	--------------------

gelochte Innendose, ungelochte Außendose, 18/8 rostfrei
perforated insert, outer case not perforated, 18/8 stainless steel
 insert perforé, boîtier non perforé, 18/8 inoxydable
inserto perforado, caja no perforada, 18/8 inoxidable
 scatola interna forata, scatola esterna non forata, inossidabile 18/8

62 mm Ø x 15 mm	tk 55250-62
-----------------	--------------------

gelochte Innendose, 18/8 rostfrei
perforated insert, 18/8 stainless steel
 insert perforé, 18/8 inoxydable
inserto perforado, 18/8 inoxidable
 scatola interna forata, 18/8 inossidabile

Nadel-Sterilisierkästen
Sterilizing trays for needles

Boîtes à stérilisation des aiguilles
Cajas de esterilización para agujas
Scatole per sterilizzazione aghi



150 mm x 95 mm x 13 mm	tk 55314-01
------------------------	--------------------

gelocht, 18/8 rostfrei
perforated, 18/8 stainless steel
perforé, 18/8 inoxydable
perforado, 18/8 inoxidable
perforato, 18/8 inossidabile



150 mm x 95 mm x 13 mm	tk 55313-01	tk 55313-02	tk 55313-03
18/8 rostfrei <i>18/8 stainless steel</i>	ungelocht <i>not perforated</i>	gelocht <i>perforated</i>	Deckel ungelocht, Boden gelocht <i>Cover not perforated, bottom perforated</i>
18/8 inoxydable <i>18/8 inoxidable</i>	non perforé <i>no perforado</i>	perforé <i>perforado</i>	Couvercle non perforé, boîtier perforé <i>Tapa no perforado, caja perforado</i>
18/8 inossidabile	non perforato	perforato	Coperchio non perforato, fondo perforato

Verschiedene Behälter
Different containers

 Boîtes diverses
 Contenedores varios
 Vassoi diversi

0.75 l	165 mm Ø x 60 mm	tk 83105-15
1.00 l	175 mm Ø x 70 mm	tk 83105-17
2.00 l	220 mm Ø x 80 mm	tk 83105-18
3.00 l	240 mm Ø x 110 mm	tk 83105-26
4.50 l	275 mm Ø x 115 mm	tk 83105-28
6.00 l	290 mm Ø x 125 mm	tk 83105-30
6.00 l	310 mm Ø x 120 mm	tk 83105-32
8.50 l	345 mm Ø x 125 mm	tk 83105-36
11.00 l	380 mm Ø x 130 mm	tk 83105-39

0.05 l	40 mm Ø x 19 mm	tk 83110-02
0.07 l	61 mm Ø x 30 mm	tk 83110-05
0.14 l	80 mm Ø x 40 mm	tk 83110-09
0.35 l	116 mm Ø x 50 mm	tk 83110-13
0.45 l	125 mm Ø x 55 mm	tk 83110-15
0.70 l	147 mm Ø x 65 mm	tk 83110-20

Schüsseln und Laborschalen, matt, 18/8 rostfrei
Bowls, tarnished, 18/8 stainless steel

 Coupoles, depoli, 18/8 inoxydable
 Palanganas, 18/8 inoxidable
 Scodelle, inossidabile 18/8

170 mm x 100 mm x 30 mm	tk 83165-17
200 mm x 120 mm x 35 mm	tk 83165-20
250 mm x 140 mm x 40 mm	tk 83165-25
275 mm x 150 mm x 50 mm	tk 83165-27

Nierenschalen, matt, 18/8 rostfrei
Kidney bowls, tarnished, 18/8 stainless steel

 Haricots, depoli, 18/8 inoxydable
 Riñoneras, 18/8 inoxidable
 Baccinella reniforme, 18/8 inossidabile

Verschiedene Behälter
Different containers

Boîtes diverses
Contentedores varios
Vassoi diversi



30 mm Ø x 90 mm	tk 83142-08
50 mm Ø x 100 mm	tk 83142-11
50 mm Ø x 130 mm	tk 83142-12
50 mm Ø x 175 mm	tk 83142-16
75 mm Ø x 100 mm	tk 83143-14
75 mm Ø x 130 mm	tk 83143-17
75 mm Ø x 175 mm	tk 83143-20

18/8 rostfrei, Standgefäße, ohne Deckel
18/8 stainless steel, mugs, without cover

18/8 inoxydable, boîtiers, sans couvercle
18/8 inoxidable, cilindros sin tapa
18/8 inossidabile, recipienti cilindrici



100 mm Ø x 50 mm	tk 83160-90
------------------	--------------------

Sputumbecher, matt, 18/8 rostfrei
Sputum mug, tarnished, 18/8 stainless steel

Coupoles, depoli, 18/8 inoxydable
Escupideras, mate, 18/8 inoxidable
Sputacchiera, 18/8 inossidabile



0,05 l	52 mm Ø x 50 mm	tk 83155-50
--------	-----------------	--------------------

Medizinbecher, graduert, matt, 18/8 rostfrei
Medicine cup, graduated, tarnished, 18/8 stainless steel

Timbale, graduée, depolie, 18/8 inoxydable
Vaso, graduado, mate, 18/8 inoxidable
Recipiente, graduato, 18/8 inossidabile



95 mm Ø x 60 mm	tk 83153-09
105 mm Ø x 60 mm	tk 83153-10
120 mm Ø x 120 mm	tk 83153-12
160 mm Ø x 140 mm	tk 83153-15

Wattedosen mit Knopfdeckel, 18/8 rostfrei
Dressing jars with cover, 18/8 stainless steel

Boîtes à pansements avec couvercle, 18/8 inoxydable
Dispensadores de algodón, 18/8 inoxidable
Dispensori di cotone, 18/8 inossidabile

Verschiedene Behälter
Different containers

 Boîtes diverses
 Contenedores varios
 Vassoi diversi

0.50 l	x = 110 mm	tk 83122-05
1.00 l	x = 140 mm	tk 83122-10
1.50 l	x = 160 mm	tk 83122-15
2.00 l	x = 180 mm	tk 83122-20

Messbecher, graduert, matt, 18/8 rostfrei
Jugs, graduated, tarnished, 18/8 stainless steel

Gobelets gradué, depoli, 18/8 inoxydable
Vasos mediadas, mate, 18/8 inoxidable
 Bicchieri graduati, 18/8 inossidabile



tk 83170-23	tk 83170-31
--------------------	--------------------

für Kinder
for children

pour enfants
para niños
 per bambini

für Erwachsene
for adults

pour adultes
para adultos
 per adulti

Stechbecken, matt, 18/8 rostfrei
Bedpans, tarnished, 18/8 stainless steel

Bassins hygiénique, depoli, 18/8 inoxydable
Silletas, mate, 18/8 inoxidable
 Padelle, 18/8 inossidabile

Instrumententablets, Instrumentenkästen
Instrument trays, Instrument boxes

Plateaux pour instruments, boîtes pour instruments
Bandejas para instrumentos, cajas para instrumentos
 Bacinelle per strumenti, scatole per strumenti



210 mm x 160 mm x 10 mm	tk 83131-19
240 mm x 180 mm x 10 mm	tk 83131-24
300 mm x 200 mm x 20 mm	tk 83131-29
350 mm x 240 mm x 10 mm	tk 83131-32
400 mm x 300 mm x 50 mm	tk 83131-38

Sprizentablets, 18/8 rostfrei

Trays for syringes, 18/8 stainless steel

Tableaux pour seringues, 18/8 inoxydable

Bandejas para jeringas, 18/8 inoxidable

Bacinelle per siringhe, 18/8 inossidabile



165 mm x 90 mm x 35 mm	tk 83147-16
200 mm x 100 mm x 50 mm	tk 83147-21
220 mm x 150 mm x 50 mm	tk 83147-22
260 mm x 150 mm x 50 mm	tk 83147-26
305 mm x 205 mm x 50 mm	tk 83147-30

Instrumentenkästen mit Deckel, matt, 18/8 rostfrei

Instrument trays with cover, tarnished, 18/8 stainless steel

Boites à instruments avec couvercle, dépoli, 18/8 inoxydable

Cajas para instrumentos con tapa, 18/8 inoxidable

Scatole per strumenti, 18/8 inossidabile

Sterilisiertrommeln
Sterilizing drums

 Tambours à stérilisation
Tambores para esterilización
 Tambori per sterilizzazione

SCHIMMELBUSCH

106 mm Ø x 116 mm	tk 55450-12
188 mm Ø x 183 mm	tk 55450-20
239 mm Ø x 159 mm	tk 55450-23
239 mm Ø x 238 mm	tk 55450-24
285 mm Ø x 159 mm	tk 55450-28
334 mm Ø x 236 mm	tk 55450-34
384 mm Ø x 286 mm	tk 55450-39

Sterilisiertrommeln, Maße inklusive überstehender Teile, 18/8 rostfrei
Sterilizing drums, overall measurements, 18/8 stainless steel

Tambours à stérilisation, dimensions totales, 18/8 inoxydable
Cilindros para esterilización, medidas totales, 18/8 inoxidable
 Scatole per sterilizzazione, 18/8 inossidabile

KONRICH

106 mm Ø x 118 mm	tk 55460-12
138 mm Ø x 105 mm	tk 55460-14
156 mm Ø x 146 mm	tk 55460-20
188 mm Ø x 140 mm	tk 55460-21
239 mm Ø x 160 mm	tk 55460-24
239 mm Ø x 240 mm	tk 55460-25
285 mm Ø x 160 mm	tk 55460-29
285 mm Ø x 240 mm	tk 55460-30
334 mm Ø x 238 mm	tk 55460-34
384 mm Ø x 288 mm	tk 55460-39

Sterilisiertrommeln, Maße inkl. überstehender Teile, 18/8 rostfrei
Sterilizing drums, overall measurements, 18/8 stainless steel

Tambours à stérilisation, dimensions totales, 18/8 inoxydable
Cilindros para esterilización, medidas totales, 18/8 inoxidable
 Scatole per sterilizzazione, 18/8 inossidabile

Sterilisierbehälter
Sterilizing cases

 Boîtes de stérilisation
 Cajas para esterilización
 Scatole per sterilizzazione

402 mm x 158 mm x 112 mm	tk 55470-01
402 mm x 158 mm x 52 mm	tk 55470-02
392 mm x 138 mm x 77 mm	tk 55470-03
392 mm x 138 mm x 32 mm	tk 55470-04
182 mm x 138 mm x 32 mm	tk 55470-05
302 mm x 158 mm x 112 mm	tk 55470-06
302 mm x 158 mm x 52 mm	tk 55470-07
332 mm x 118 mm x 67 mm	tk 55470-08
332 mm x 118 mm x 27 mm	tk 55470-09
162 mm x 118 mm x 27 mm	tk 55470-10



Behälterunterteil und Deckel sind tiefgezogen. Beide Teile sind gelocht und mit Baumwollfiltern ausgestattet. Zum raschen Filterwechsel wurden jeweils nur zwei Rändelmutter angebracht. Der Deckel ist aus rostfreiem Edelstahl 1.4301 hergestellt. Eine im Deckel integrierte Silikonichtung sorgt für absolute Dichtigkeit. Das Behälterunterteil aus Aluminium ist bronzeeloxiert, kann aber auf Wunsch auch andersfarbig eloxiert werden. Die Schnellspannverschlüsse mit Tragegriff sind plombierbar und ab einer Höhe von 60 mm angebracht.

Both parts are deep-drawn. Both parts are perforated and include cotton filters. Easy handling for changing the filters. The cover is made of stainless steel NO. 1.4301. A silicone sealing is incorporated in the cover to ensure a absolute thightness. The bottom part ist made of eloxated aluminium. Colours on request. The locking systems can be sealed and are fixed in a height of 60 mm.

Couvercle et boîtier sont emboutis. Les deux parties sont perforées et contiennent des filtres en coton. Changement rapide des filtres avec deux molettes. Le couvercle est d'acier inox 1.4301. Un joint en silicone dans le couvercle garanti l'étanchéité. Le boîtier est d'aluminium eloxé. Différentes couleurs sur demande. Les fermetures et poignées peuvent êtres plombées. Elles sont fixées à partir d'une altitude de 60 mm.

Fondo y tapa son embutidos. Ambos partes son perforados y equipados con filtros de textil. Cambio rapido de los filtros. La tapa es de acero inoxidable 1.4301. Juntas de silicona, incorporadas en la tapa garantizan la hermetizidad de los contenedores. El fondo es de aluminio eloxado. Colores según demanda. Los cierres y los mangos pueden ser plombeados y son montados a partir de una altitud de 60 mm.

Coperchio e contenitore costruiti in un pezzo unico, senza saldature; entrambi sono forati e sono forniti di filtri di cotone. Facilità di sostituzione dei filtri. Il coperchio è fatto di acciaio inox N. 1.4301. Una guarnizione in silicone è incorporata nel coperchio per assicurare una ermeticità assoluta. Il fondo è di alluminio anodizzato. Colori su richiesta. Il sistema di chiusura può essere sigillato ed il fissaggio ha una altezza di 60 mm.

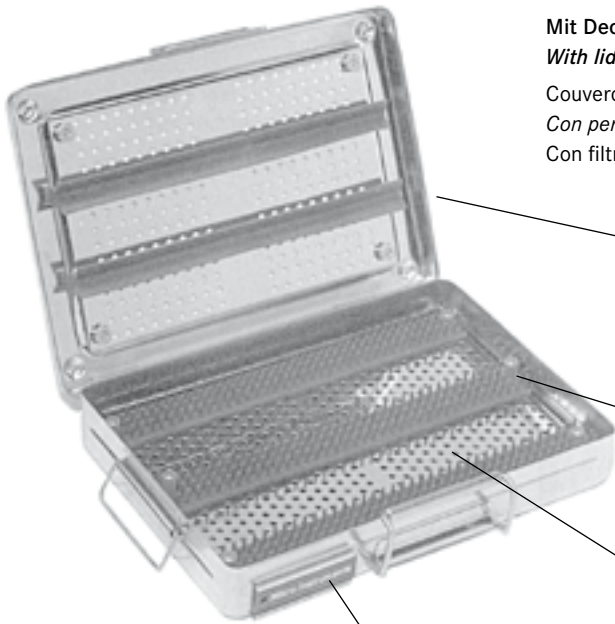
Instrumenten-Kassetten aus Edelstahl
Instrument trays made of stainless steel
Contenaires d'instruments en acier inox
Caja para instrumental en acero inox
Scatole per sterilizzazione di acciaio inossidabile

Mit Deckel- und Bodenlochung mit Textil-Langzeitfiltern für Dampfsterilisation
With lid and bottom perforation with textil "Longterm" filters for steam sterilisation
 Couvercle et boîtier perforé avec filtre en textile pour stérilisation à vapeur
Con perforación en tapa y fondo, con filtros en tejido para esterilización a vapor
 Con filtri tessili, per la sterilizzazione a vapore

Silikon-Andrückleisten zum Fixieren der Instrumente
Silicone protective strips for fixation of instruments

Tapis en silicone pour fixer les instruments
Tiras de silicon para fijar los instrumentos
 Righe di silicone per fissare gli strumenti

Silikon-Noppenstreifen zur schonenden Auflage der Instrumente
Silicon strips for a soft and protective storage of the instruments

Tapis en silicone pour la protection des instruments
Matas de silicon para proteger los instrumentos
 Stuoie di silicone per proteggere gli strumenti

1 herausnehmbare Siebplatte
1 removable tray insert

1 tableau pour sortir
1 placa para sacar
 1 cestello

Kennzeichnungsschilder nach Wahl (Farbe und Text)
Marking plate for selection: colour and description

Plaquette d'identification (texte et couleur selon demande)
Placas de identificación a opción (color y texto)
 Placche d'identificazione (colore a scelta)

280 x 195 x 55 mm	265 x 255 x 55 mm	380 x 260 x 55 mm	200 x 140 x 55 mm	470 x 250 x 55 mm
tk 85100-01	tk 85101-01	tk 85102-01	tk 85103-01	tk 85104-01

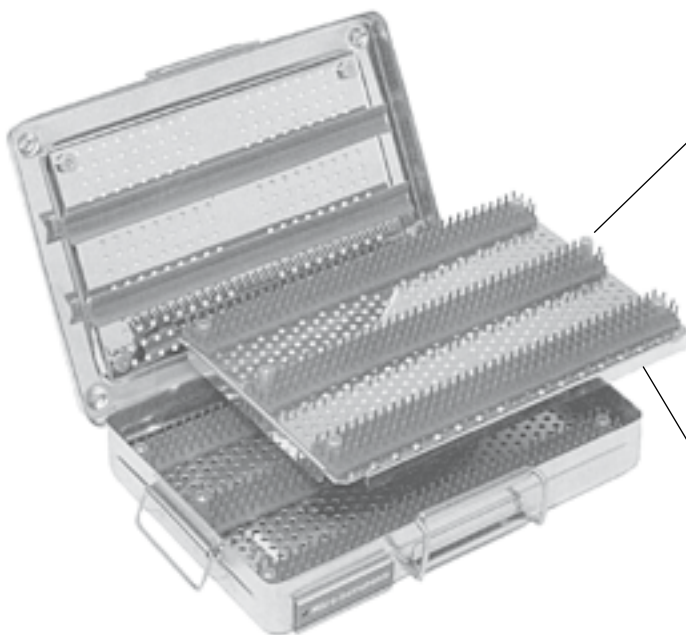

wärmeisolierende Halteknöpfe zum Herausheben
heatisolated handles

pins isolés pour sortir des tableaux
pernos aislados para sacar las placas
 maniglia a forma di botone

2 herausnehmbare Siebplatten
2 removable tray inserts

2 tableaux detachables
2 placas para sacar
 2 cestelli

Silikon-Andrückleisten an der Unterseite des Siebes
Silicone protective strips at the lower side of the tray

Tapis de silicone à la partie inférieure des tableaux
Tiras de silicon a bajo de las placas
 Righe di silicone

280 x 195 x 65 mm	265 x 255 x 65 mm	380 x 260 x 65 mm	200 x 140 x 65 mm	470 x 250 x 65 mm
tk 85100-03	tk 85101-03	tk 85102-03	tk 85103-03	tk 85104-03

Pflegemittel – Spezial Ölspray
Detergent – special oilspray

Détergent – spray huileux
Detergente – spray de aceite
 Detergente – olio speciale spray



500 ml	100 ml
tk 95000-00	tk 95100-00

TEKNO spezial Öl zur Instrumentenpflege
TEKNO special oil for surgical instruments

TEKNO huileux pour des instruments
TEKNO aceite para instrumentos

TEKNO olio speciale per strumentario chirurgico

Wagen
Trolley

Chariot
Carro
Carrello



600 x 400 x 800 mm
tk 83217-20

700 x 500 x 800 mm
tk 83217-21



MAYO
680 x 450 x 900 mm
tk 83217-00



max. 2220 mm
tk 83217-10

Sterilisierbehälter
Sterilizing cases

Boîtes de stérilisation
Cajas para esterilización
Scatole per sterilizzazione



Bitte fordern Sie unseren Spezialkatalog an.
Please ask for our special catalogue.

Veuillez demander pour notre catalogue spécial.
Por favor preguntan para el catalogo especial.

Per favore domandate per il nostro catalogo speciale

Wichtige Hinweise

Dieser Katalog bleibt Eigentum der Firma TEKNO-MEDICAL Optik-Chirurgie GmbH, auch wenn dafür eine Schutzgebühr bezahlt wurde. Er kann von uns jederzeit zurückgefordert werden, wenn er gegen unsere Interessen und nicht zum Vertrieb und Einkauf von TEKNO Produkten verwendet wird. Auch behalten wir uns in solch einem Falle weitergehende Maßnahmen vor.

Der Nachdruck oder Kopieren dieses Kataloges – im Gesamten oder auch nur auszugsweise – ist ohne unsere schriftliche Genehmigung verboten.

Modelländerungen vorbehalten. Gedruckt in der Bundesrepublik Deutschland

Important notice

This catalogue remains property of TEKNO-MEDICAL Optik-Chirurgie GmbH even if we have asked for a lending fee of charges. We can at any time recall the catalogue, in case that it has been not used according to our interests, i.e. sale or purchase of TEKNO products. We preserve the right for further steps in that case.

Reproduction or copying of this catalogue in whole or in parts is forbidden without our written permission.

Patterns are subject to change. Printed in Germany

Indications importantes

Ce catalogue reste la propriété de TEKNO-MEDICAL Optik-Chirurgie GmbH, même si nous avons demandé le paiement d'une taxe de protection. Nous pouvons demander le retour du catalogue dans le cas où celui-ci n'est pas utilisé conformément à nos intérêts, pour la vente ou l'achat de nos produits. Dans ce cas nous nous réservons le droit de mener des actions juridiques.

La reproduction ou la copie totale ou partielle de ce catalogue est interdite sans notre accord écrit.

Sous réserve des modifications techniques. Imprimé en Allemagne

Avisos importantes

Este catálogo es propiedad de TEKNO-MEDICAL Optik-Chirurgie GmbH, aún en el caso de haber abonado por él una tasa de colaboración. Podemos solicitar la devolución del catálogo en caso de que no sea utilizado para la compra o venta de nuestros productos. En este caso nos reservamos el derecho de tomar medidas jurídicas.

La reproducción o copia total o parcial de este catálogo esta prohibido sin nuestro consentimiento escrito.

Salvo modificaciones técnicas. Impreso en la República Federal de Alemania

Avvertenze importanti

Questo catalogo rimane proprietà della TEKNO-MEDICAL Optik-Chirurgie GmbH, anche se è stato rilasciato gratuitamente o contro pagamento. Possiamo in ogni momento richiederlo indietro, in caso non stato usato in accordo con i nostri interessi (acquisto e vendita dei prodotti TEKNO-Medical). Ci riserviamo in questo caso il diritto di prendere ulteriori provvedimenti.

La copia o la riproduzione di questo catalogo in parte o nella sua totalità è vietata senza il nostro permesso scritto.

Ci riserviamo la facoltà di cambiamenti nei modelli. Stampato in Germania



TEKNO-MEDICAL Optik-Chirurgie GmbH

Sattlerstrasse 11 · 78532 Tuttlingen, Germany
Telefon +49 (74 61) 17 01-0 · Fax +49 (74 61) 17 01-50
mail@tekno-medical.com · www.tekno-medical.com

© Copyright 11.2017 - **TEKNO-MEDICAL** Optik-Chirurgie GmbH
TEKNO is a registered trademark of **TEKNO-MEDICAL** Optik-Chirurgie GmbH